

Zadanie: Narysować wykresy sił N, T, M. Zadanie rozwiązać metodą przemieszczeń

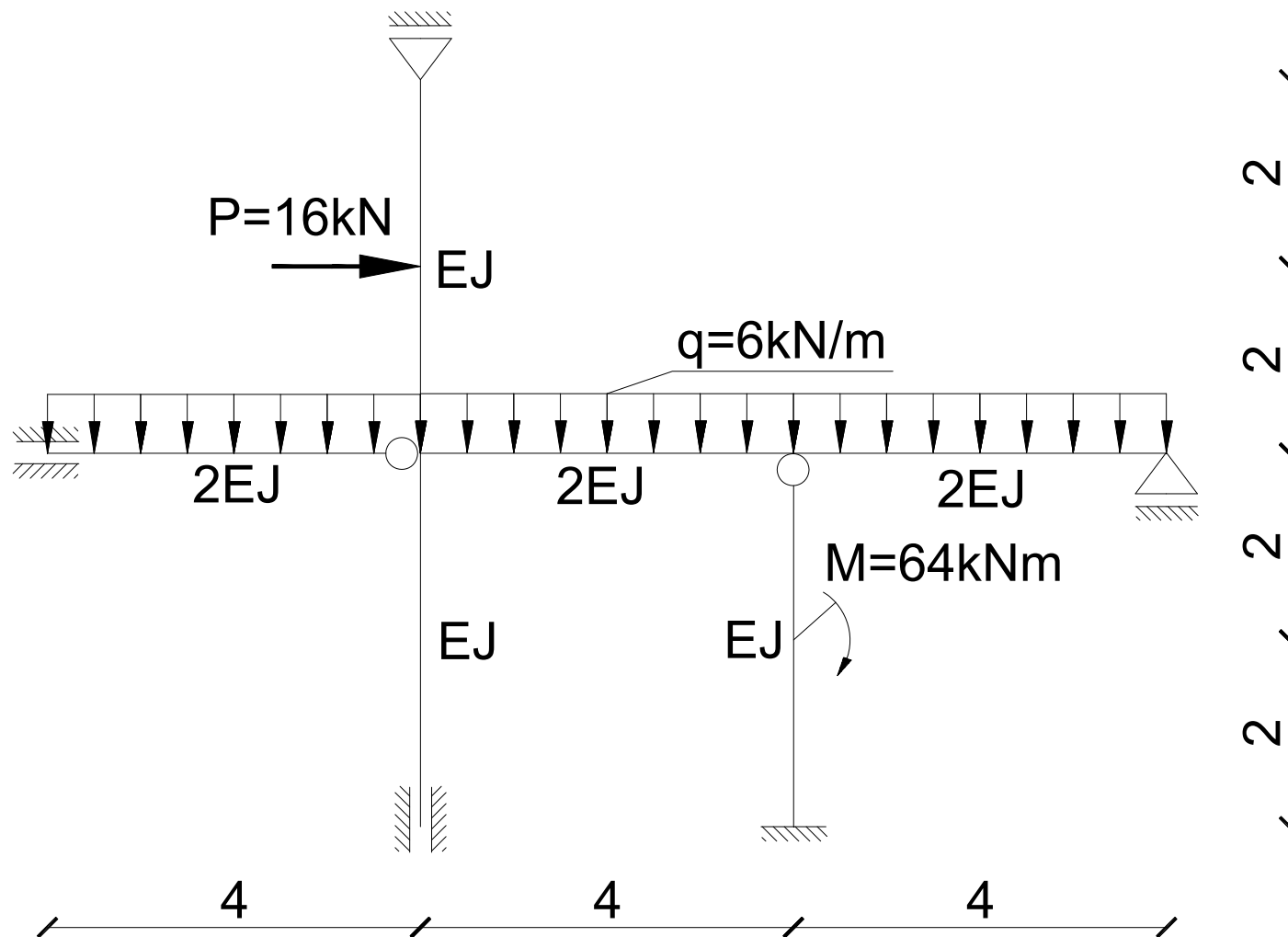

Schemat podstawowy geometrycznie wyznaczalny

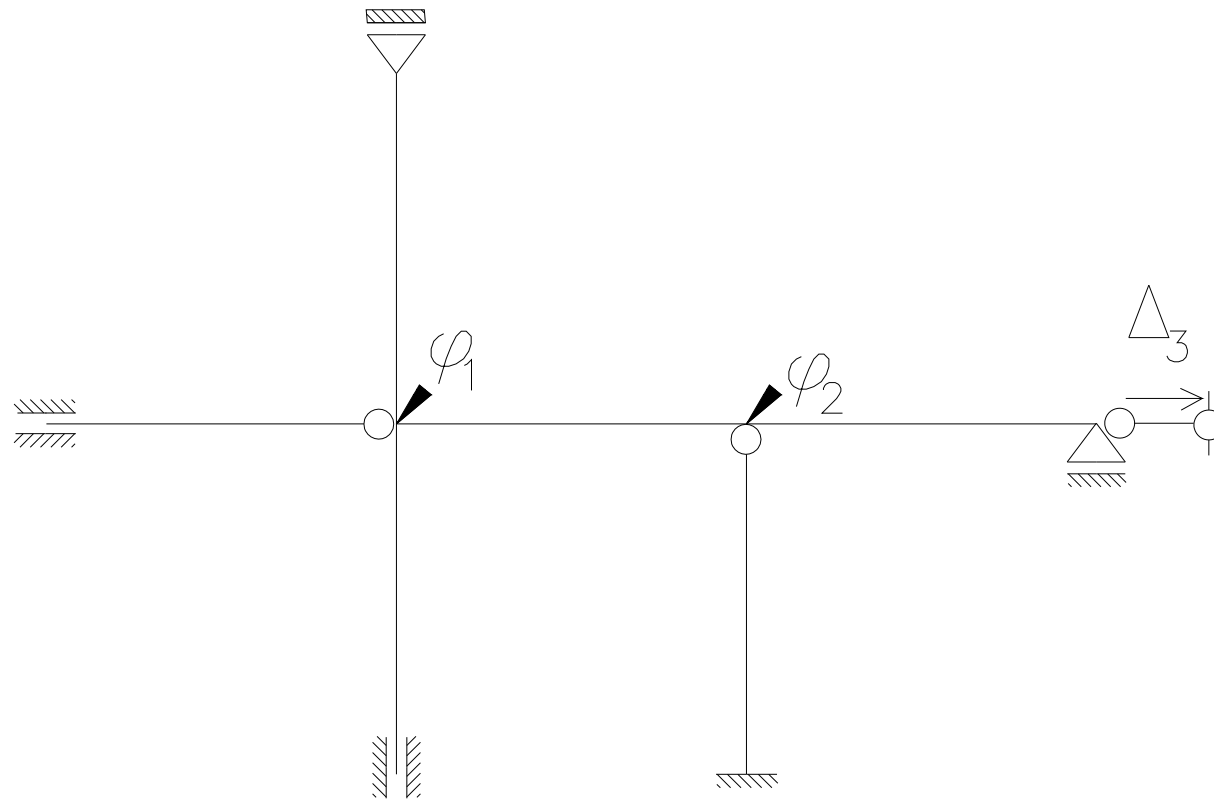

Schemat podstawowy geometrycznie wyznaczalny

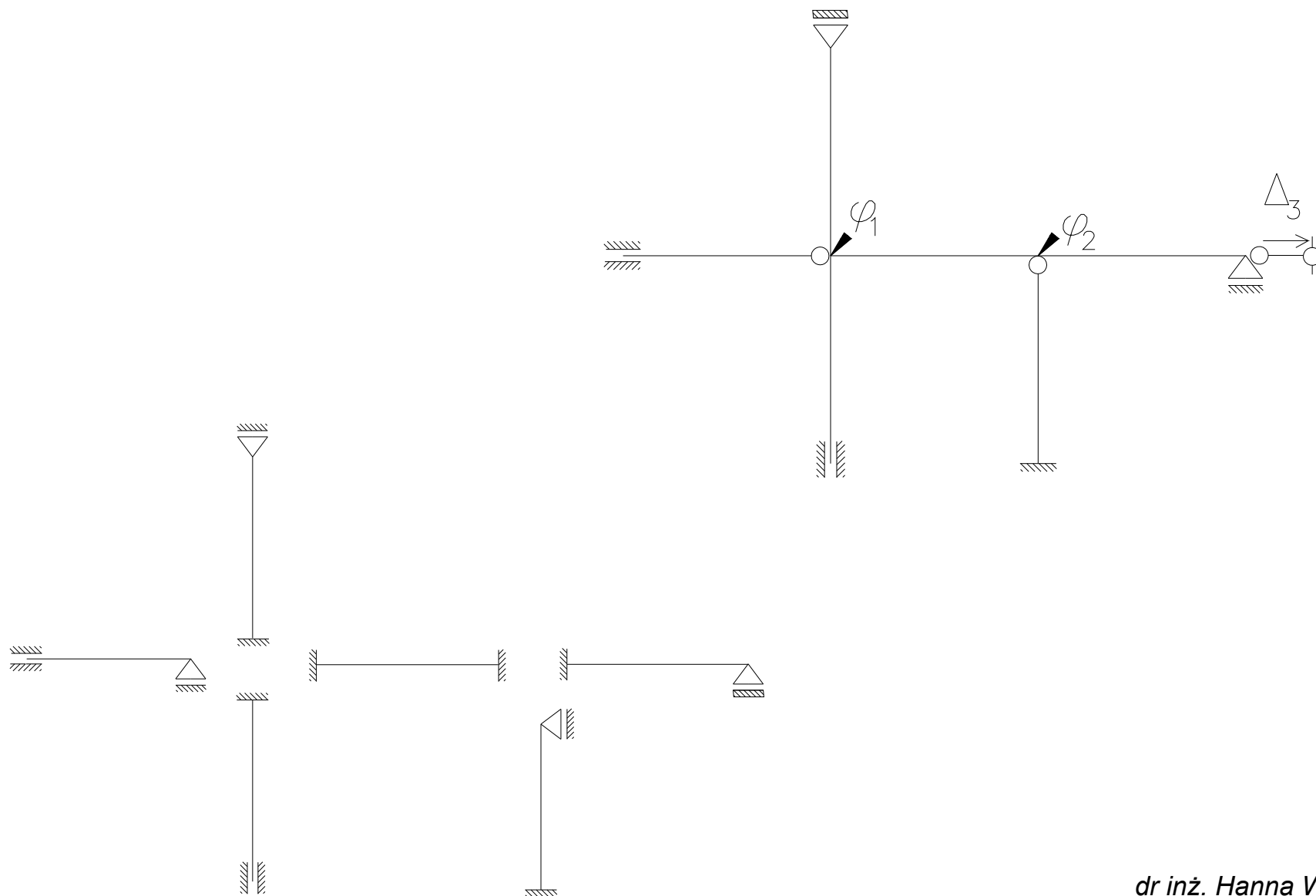

Stan $\varphi_1=1$

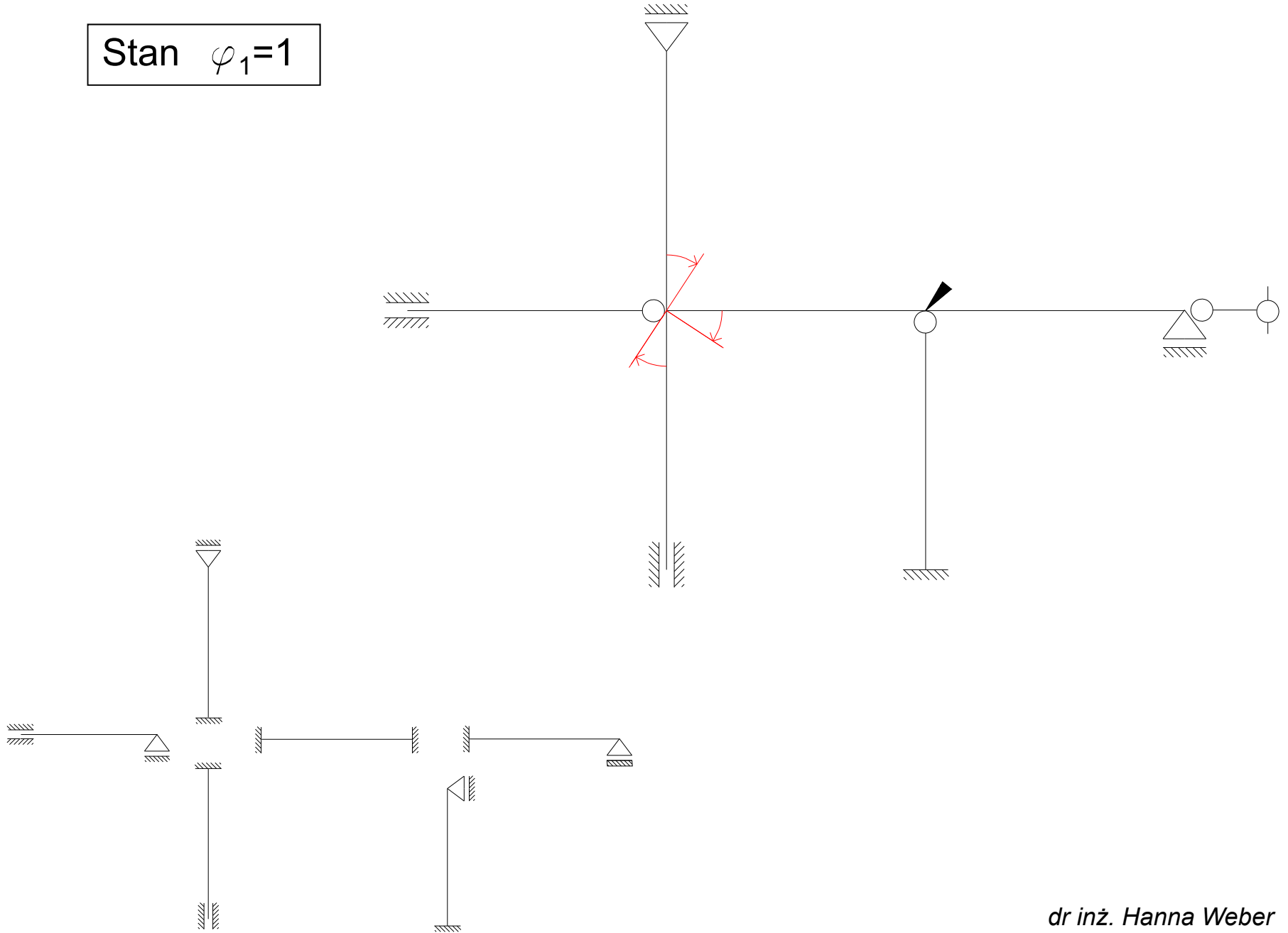

dr inž. Hanna Weber

Stan $\varphi_1=1$

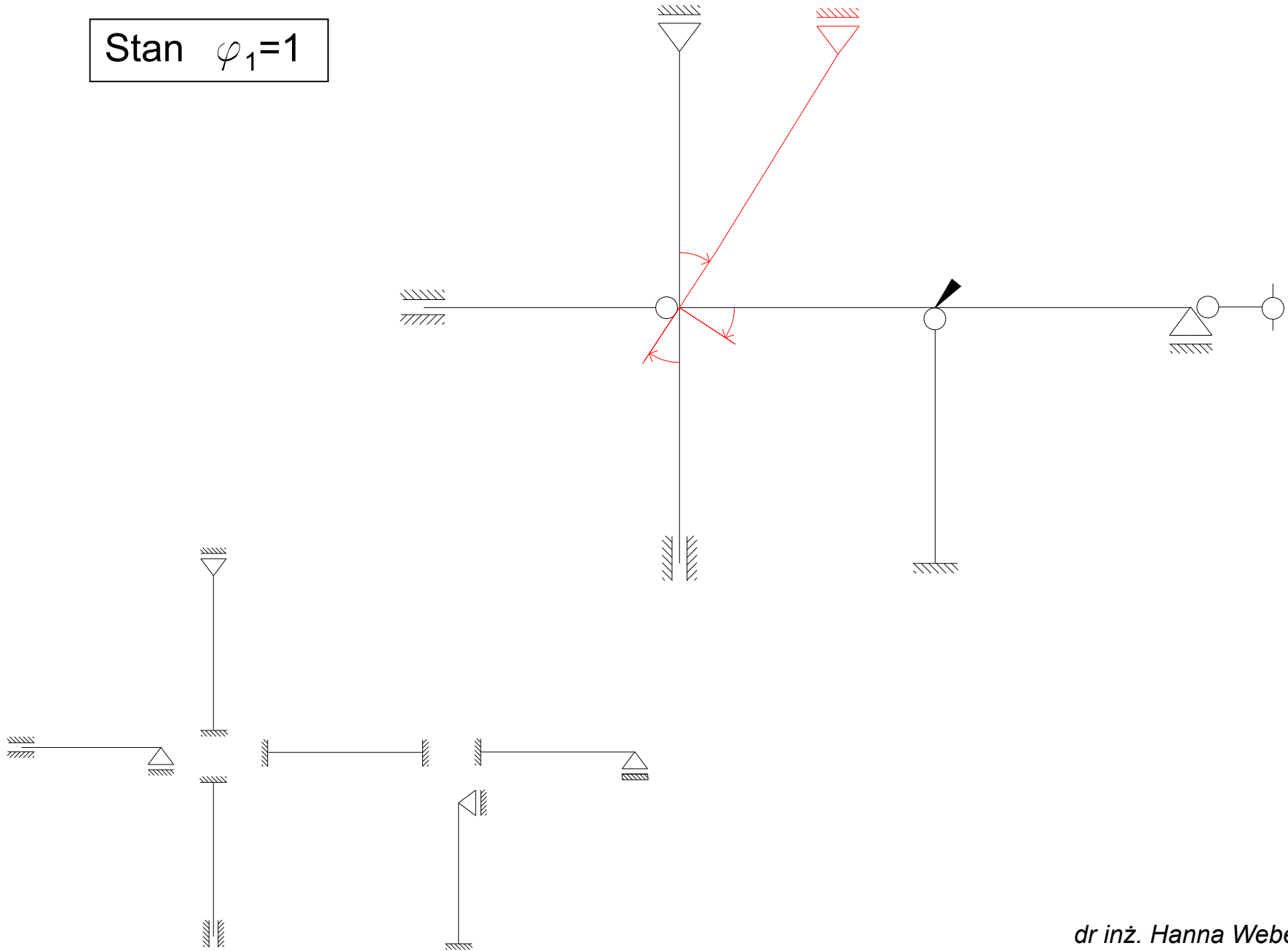

dr inž. Hanna Weber

Stan $\varphi_1=1$

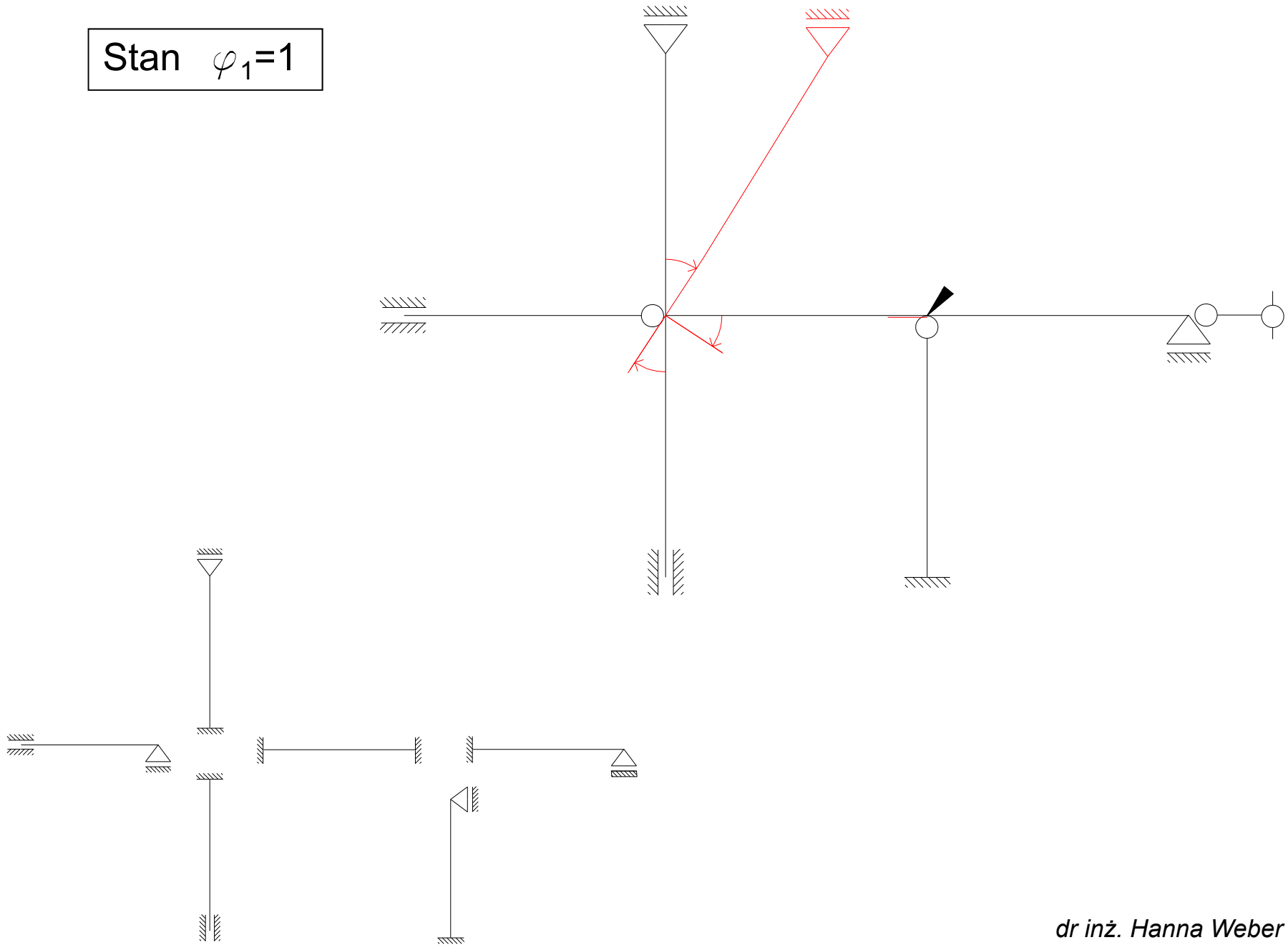

dr inž. Hanna Weber

Stan $\varphi_1=1$

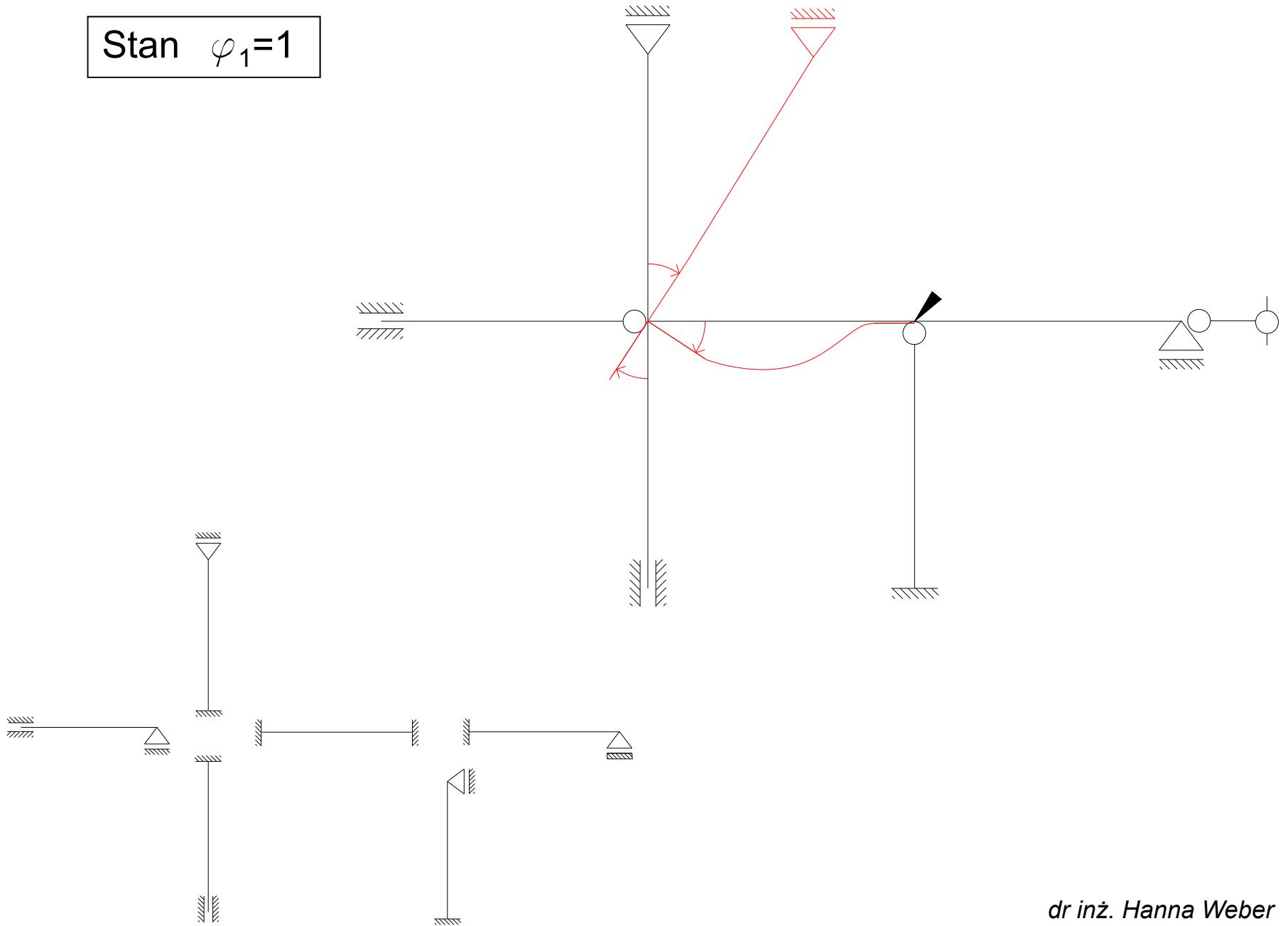

dr inž. Hanna Weber

Stan $\varphi_1=1$

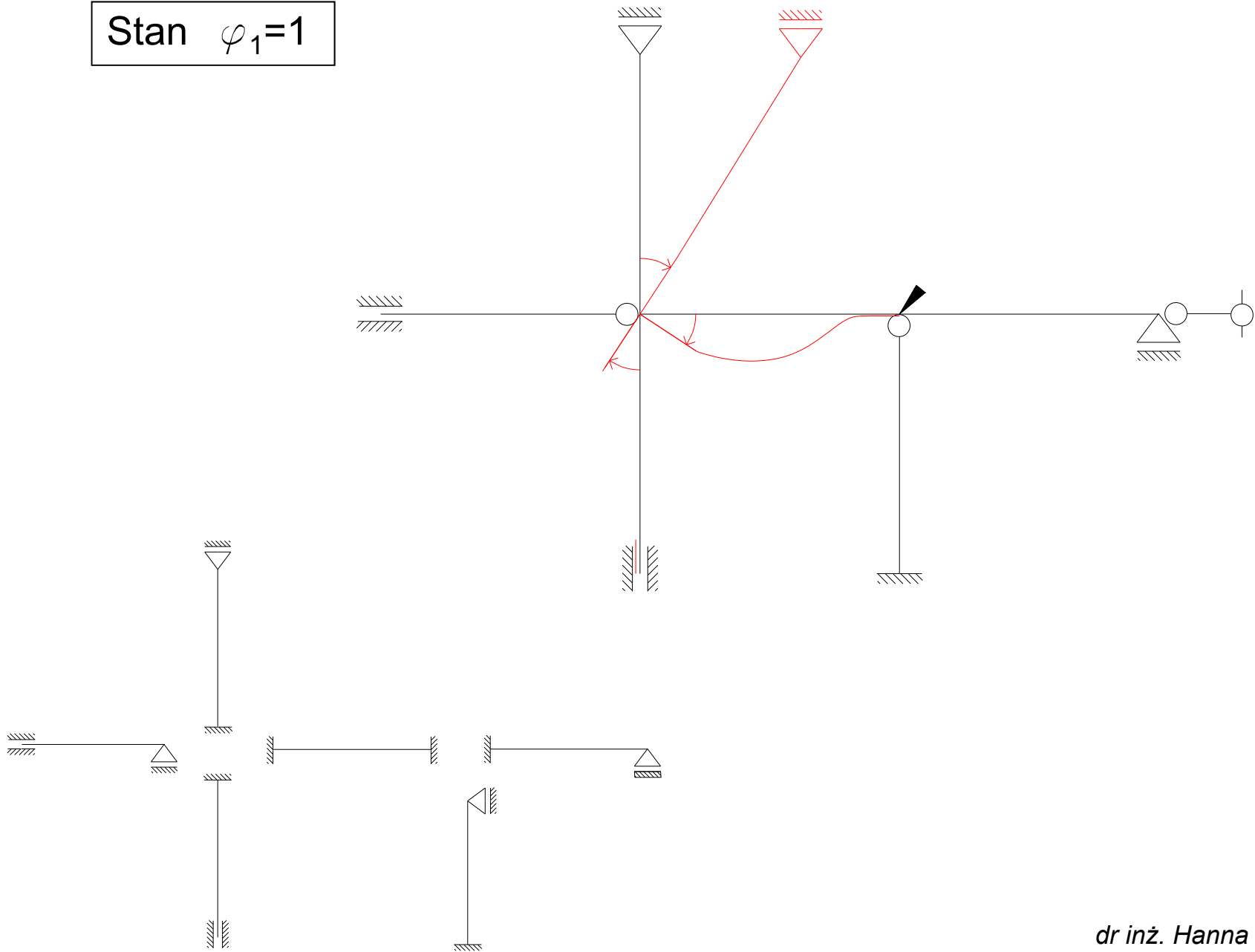

dr inž. Hanna Weber

Stan $\varphi_1=1$

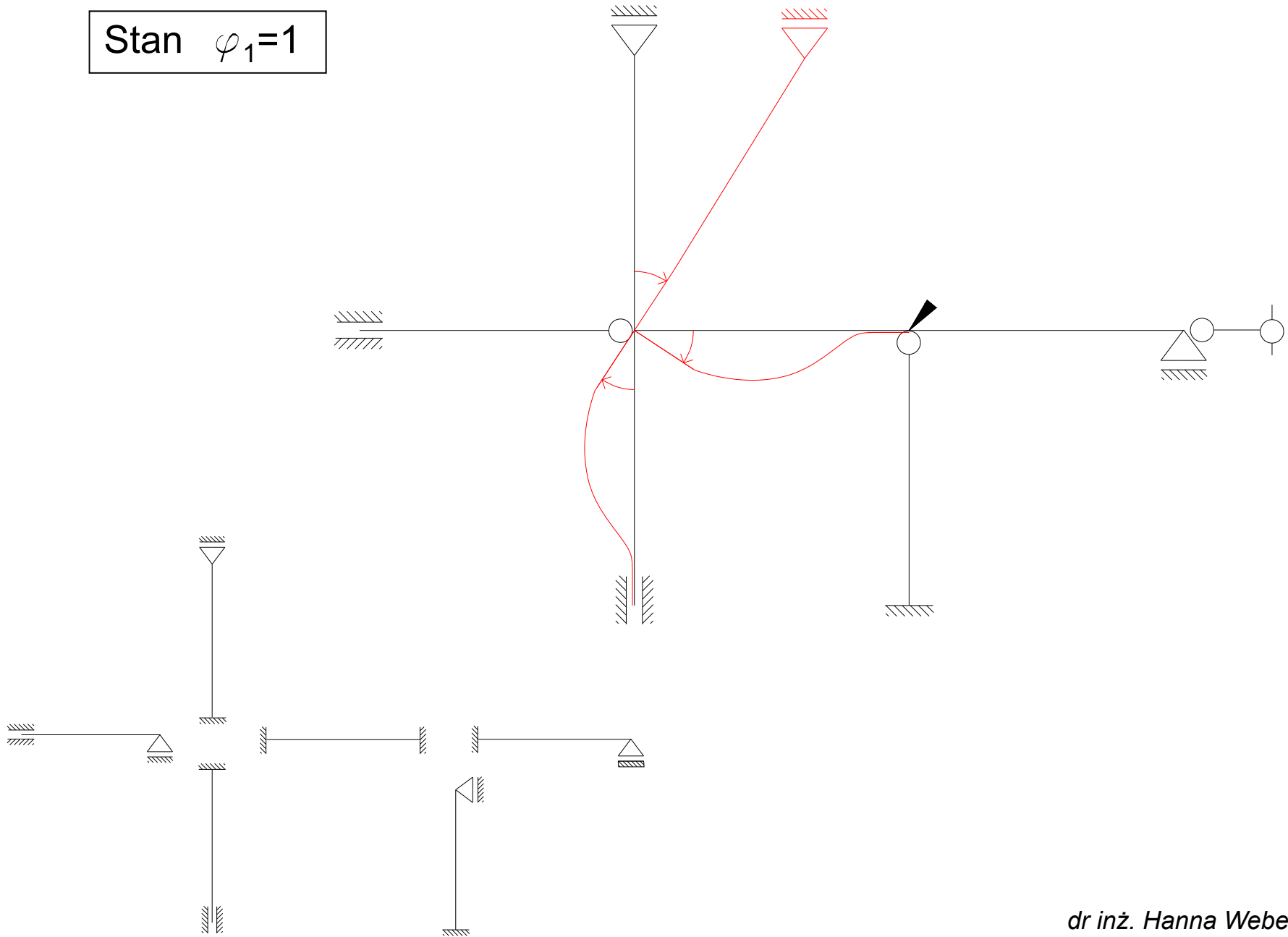

dr inž. Hanna Weber

Stan $\varphi_1=1$

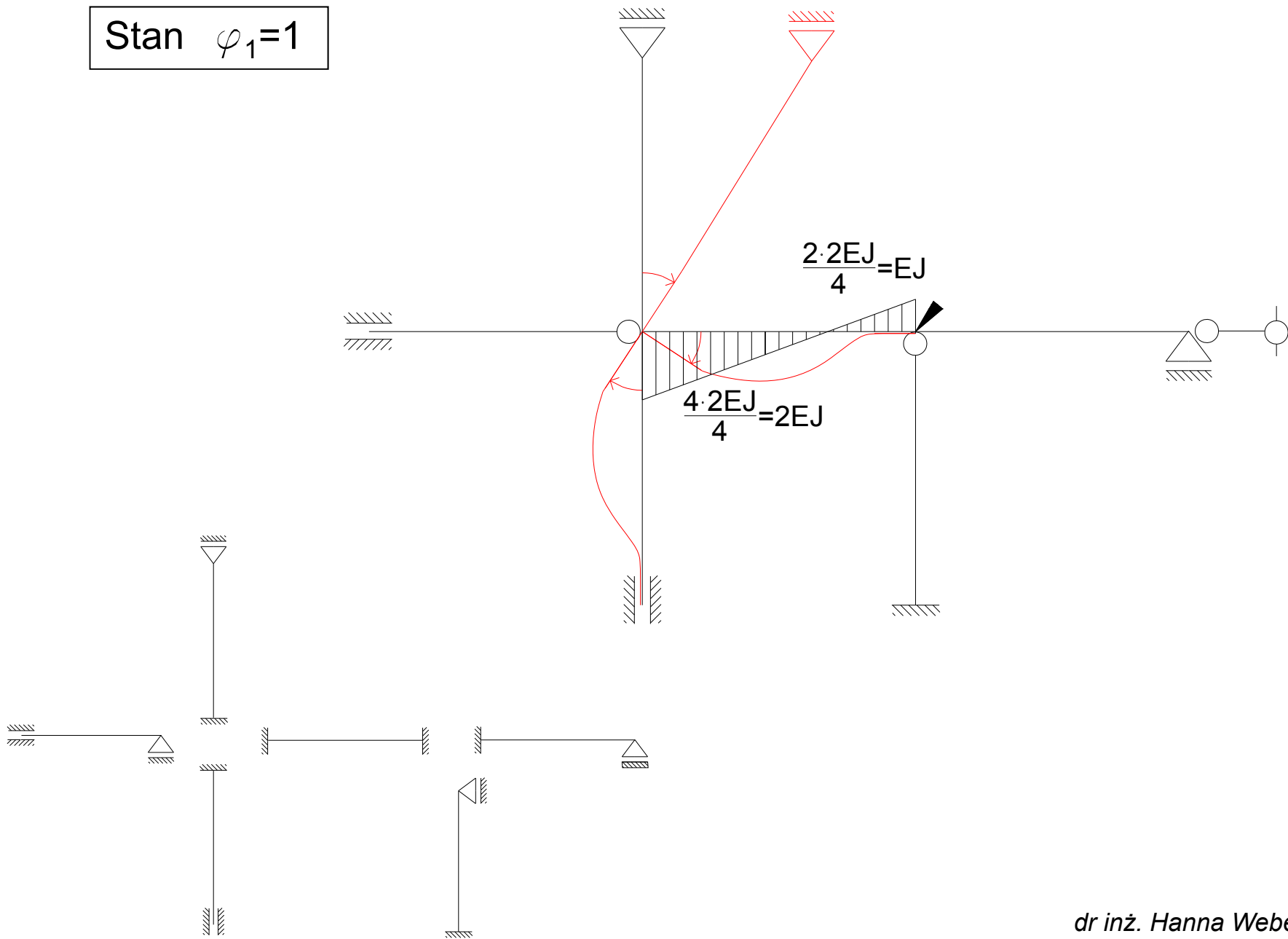

dr inž. Hanna Weber

Stan $\varphi_1=1$

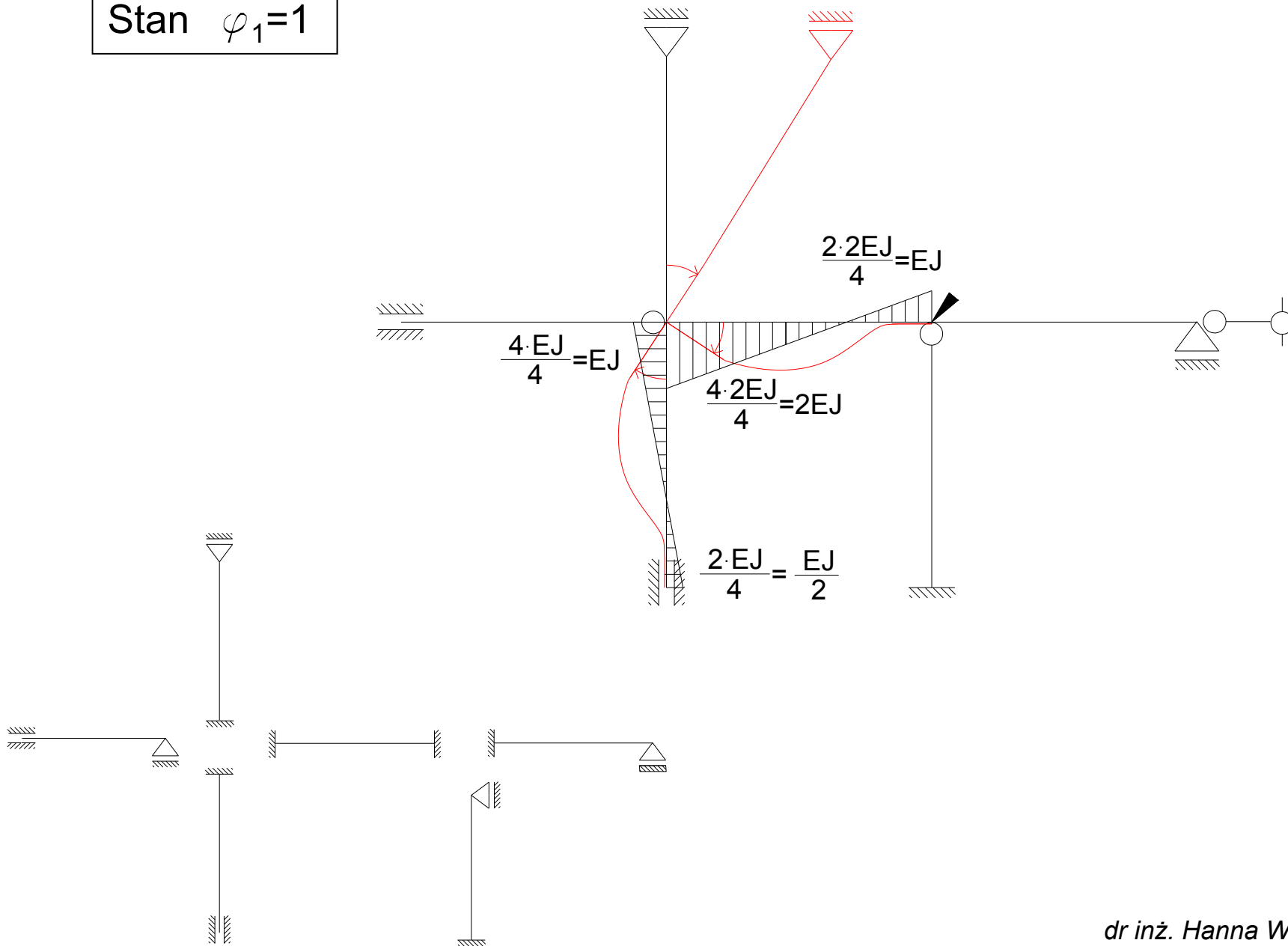

dr inž. Hanna Weber

Stan $\varphi_1=1$

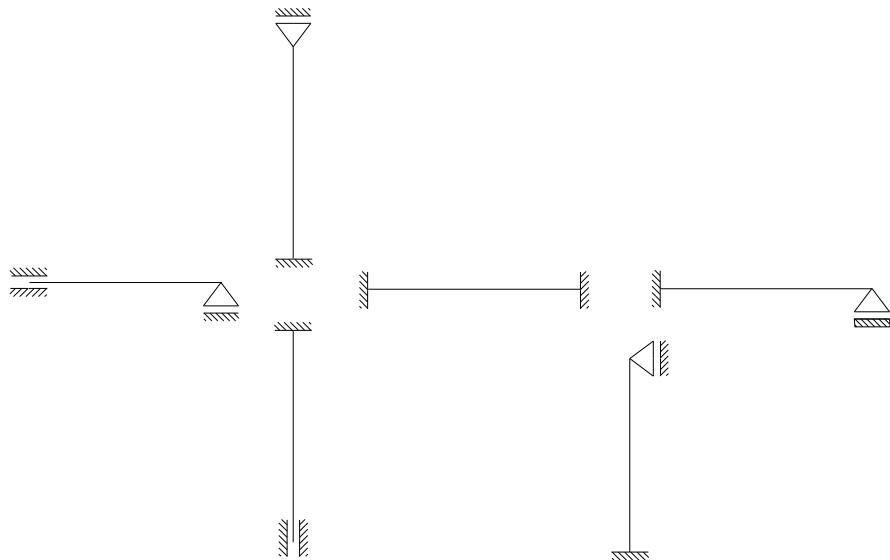
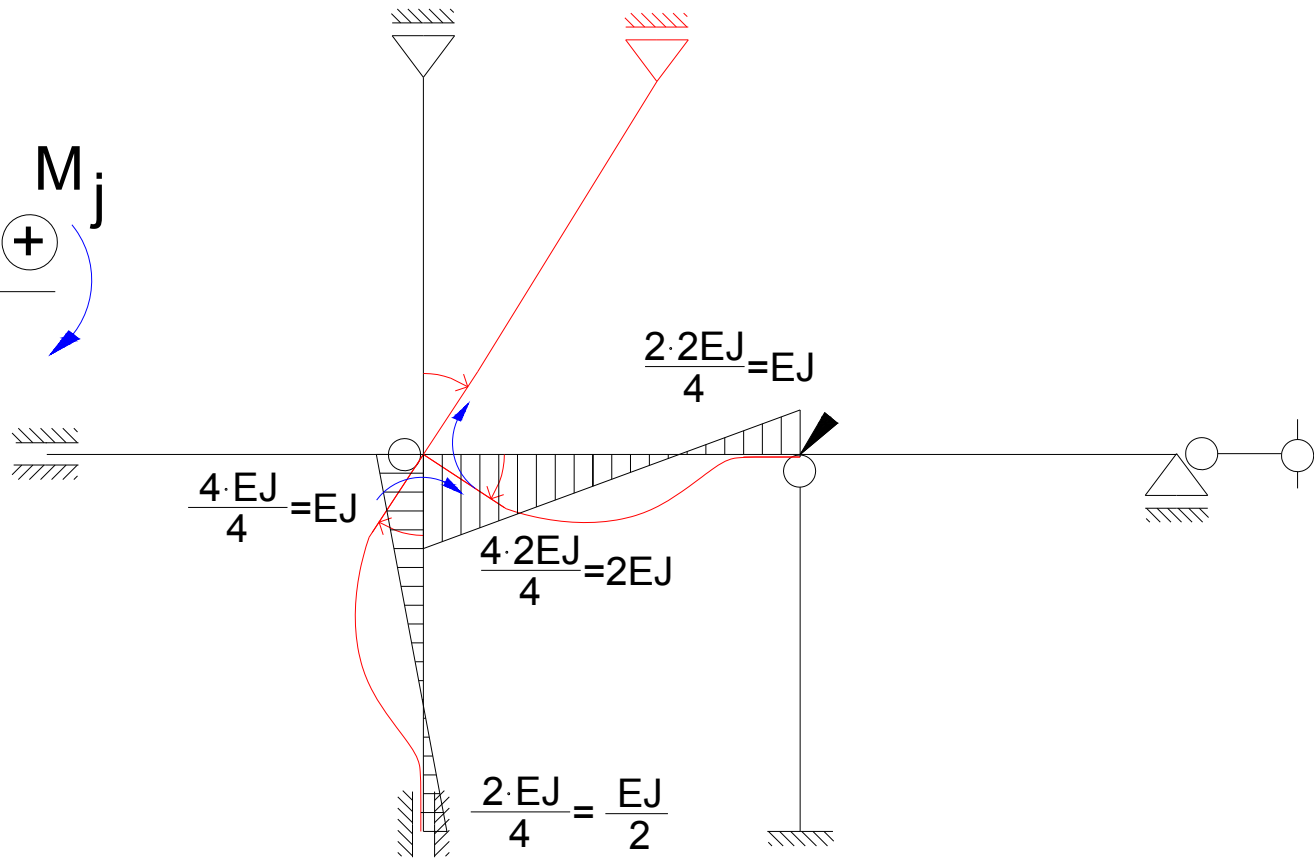
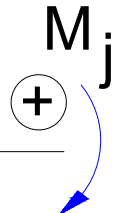
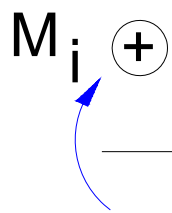

Stan $\varphi_1=1$

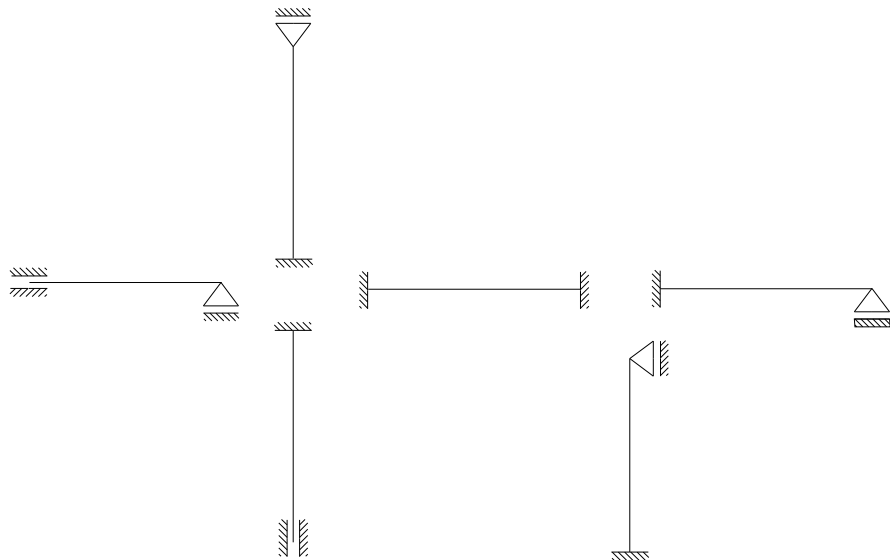
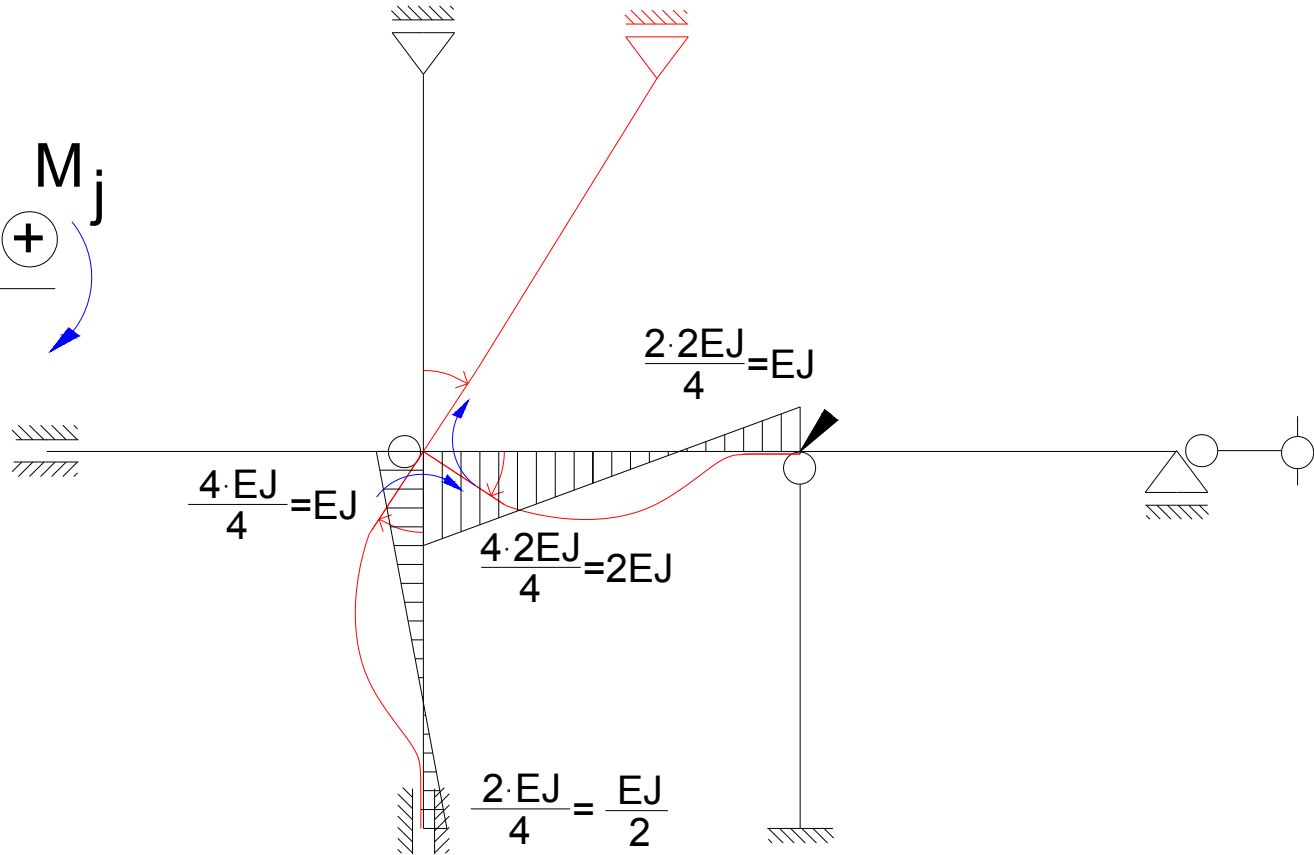
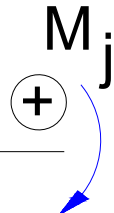
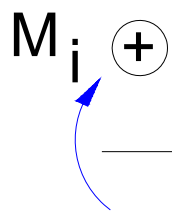

$$k_{11} = EJ + 2EJ = 3EJ$$

$$k_{21} = EJ$$

Stan $\varphi_2=1$

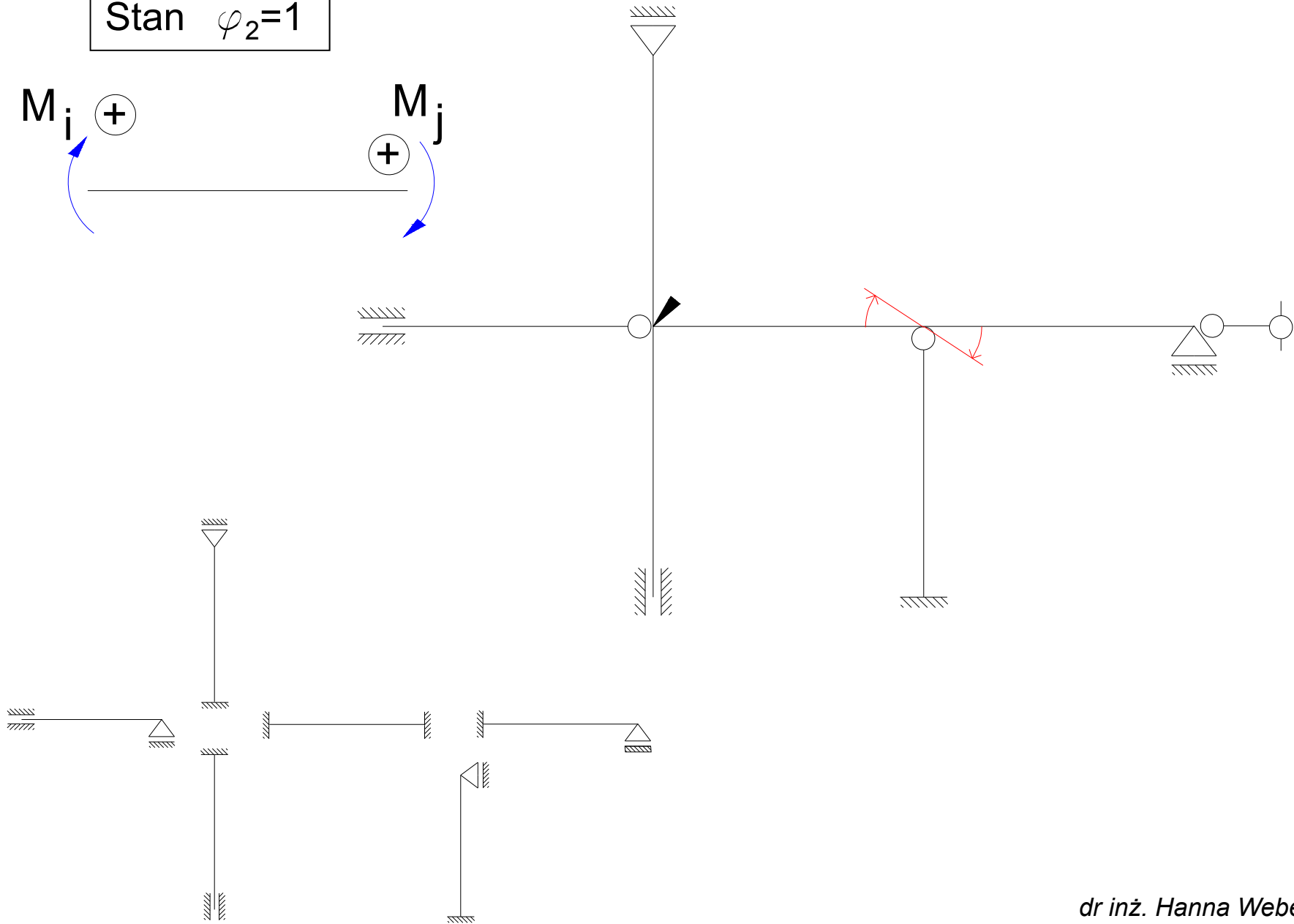
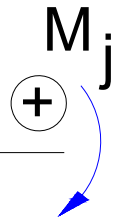
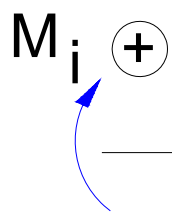

dr inž. Hanna Weber

Stan $\varphi_2=1$

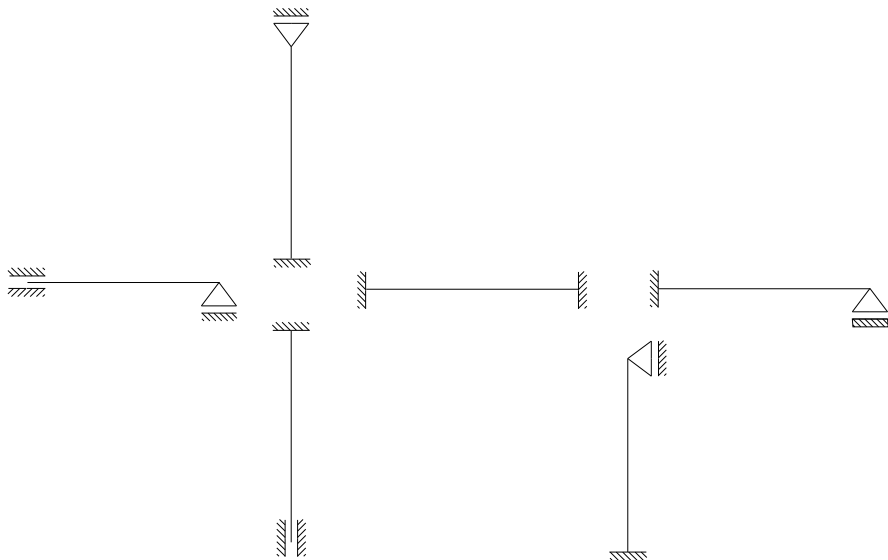
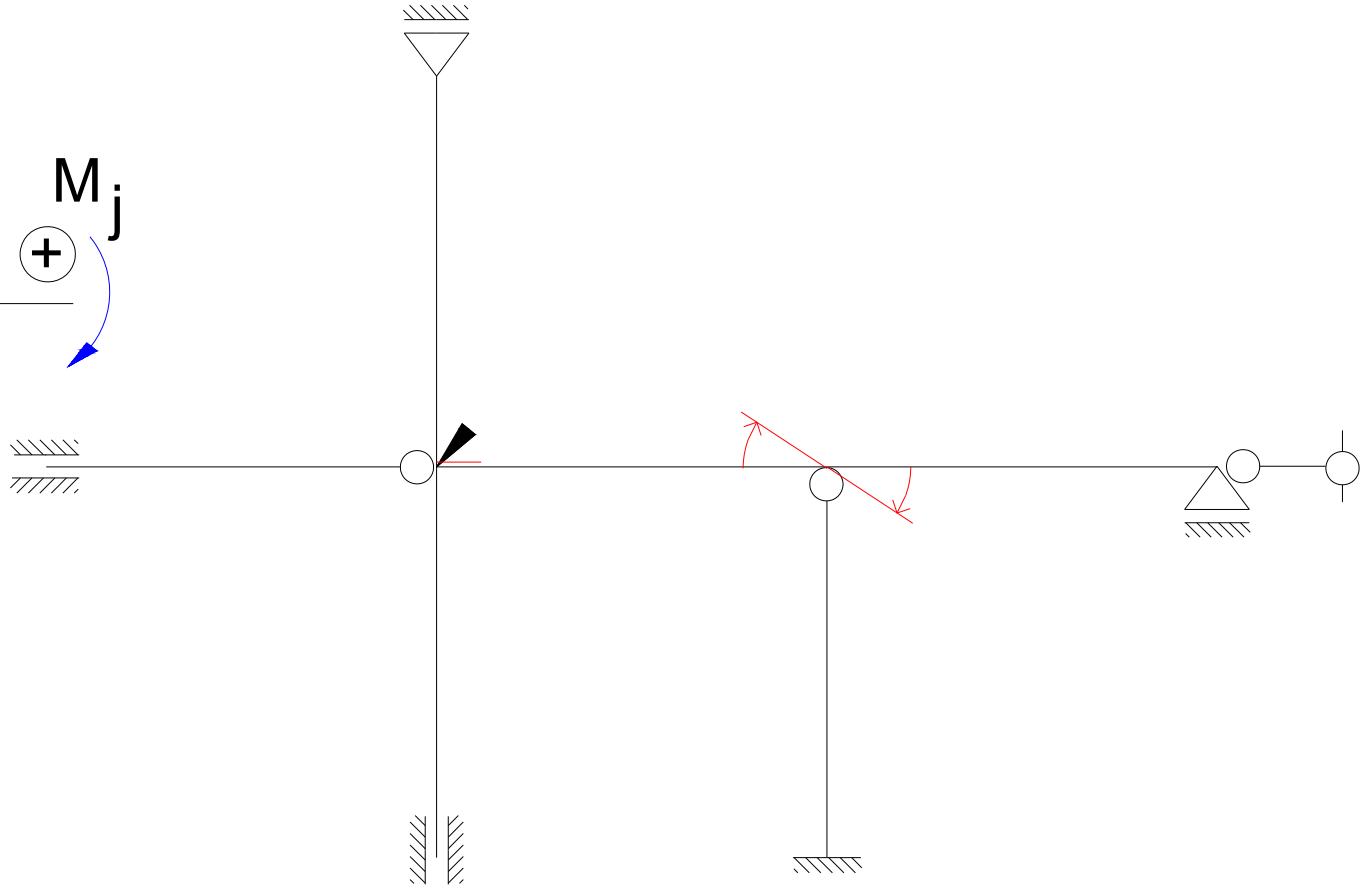
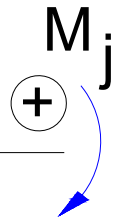
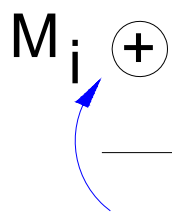

dr inž. Hanna Weber

Stan $\varphi_2=1$

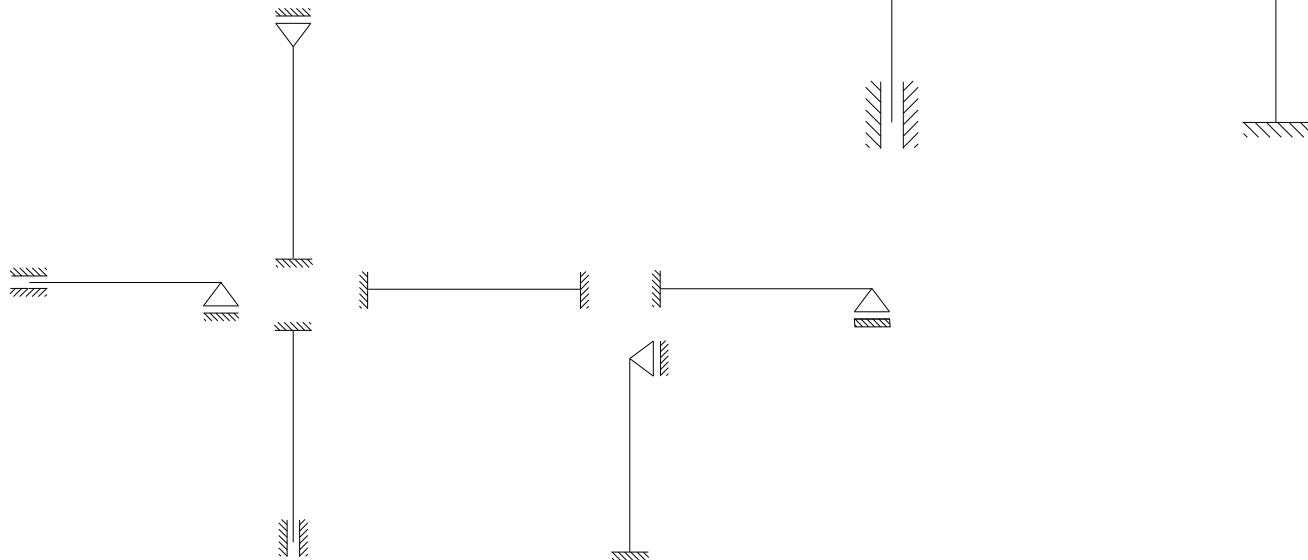
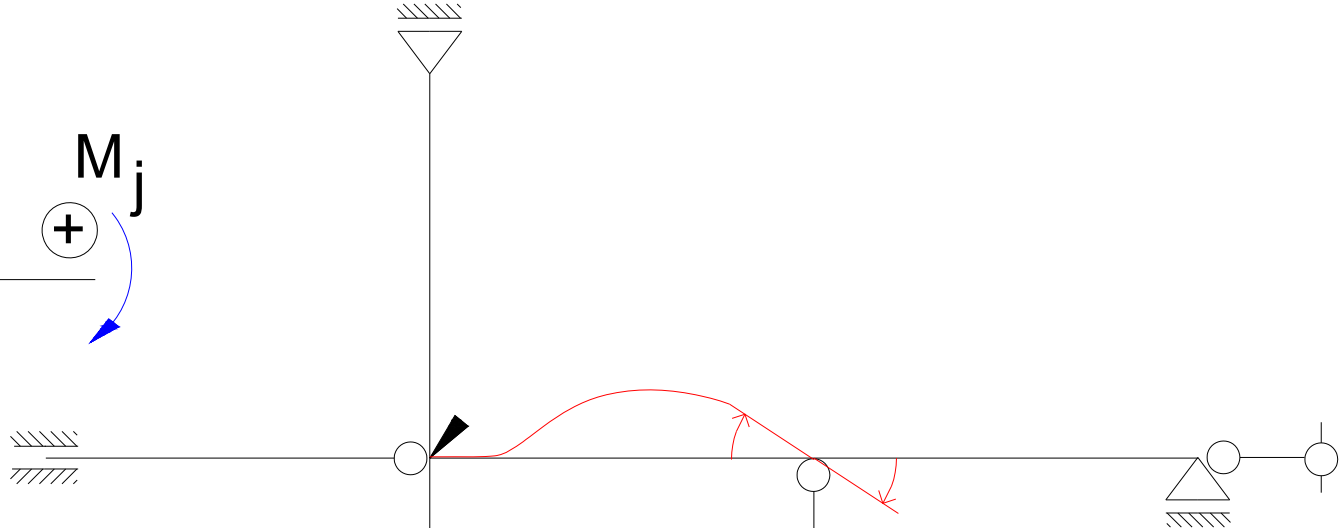
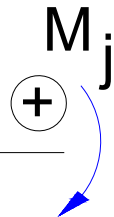
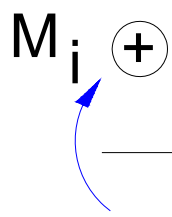

dr inž. Hanna Weber

Stan $\varphi_2=1$

M_i (+)

M_j (+)

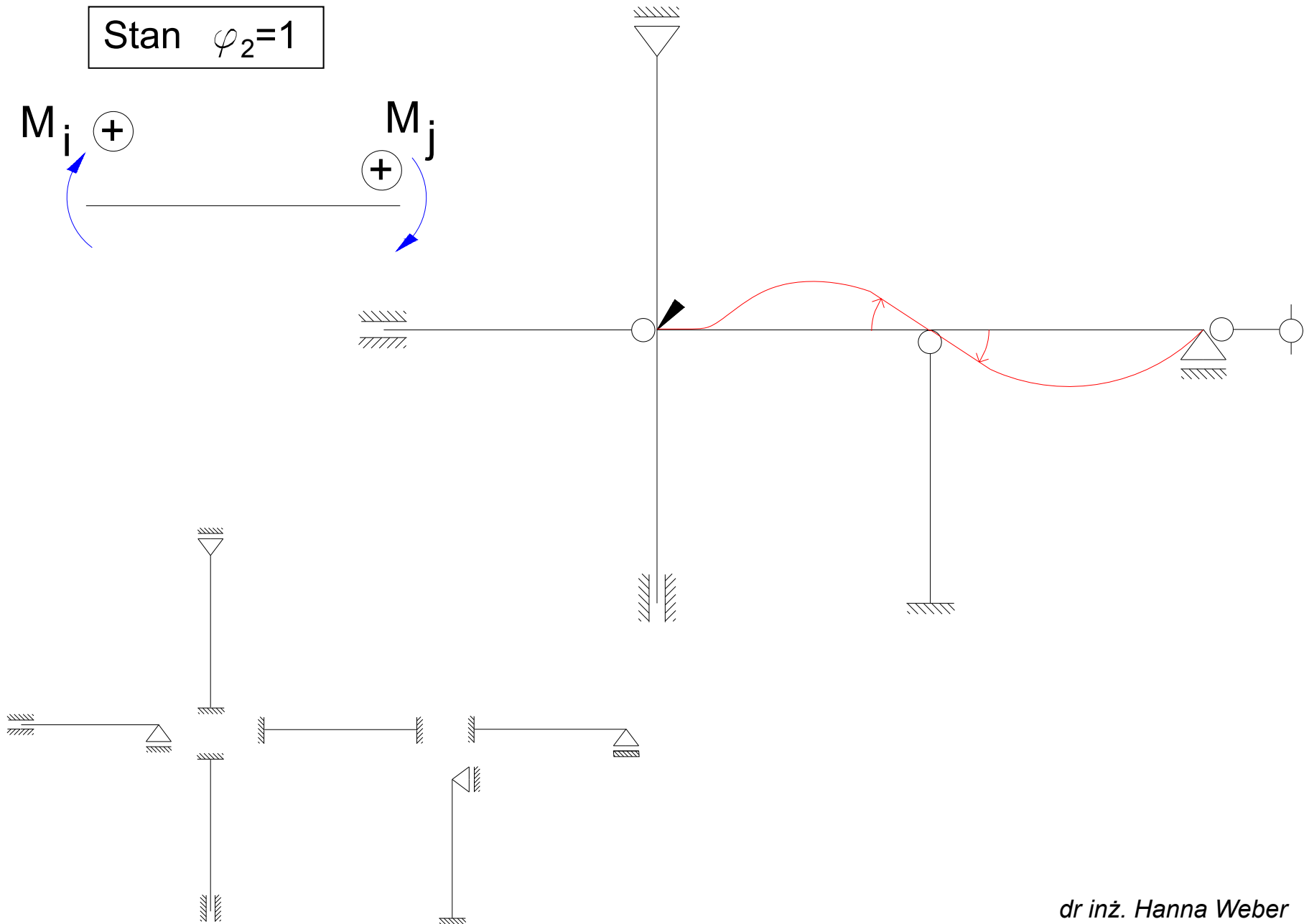

dr inž. Hanna Weber

Stan $\varphi_2=1$

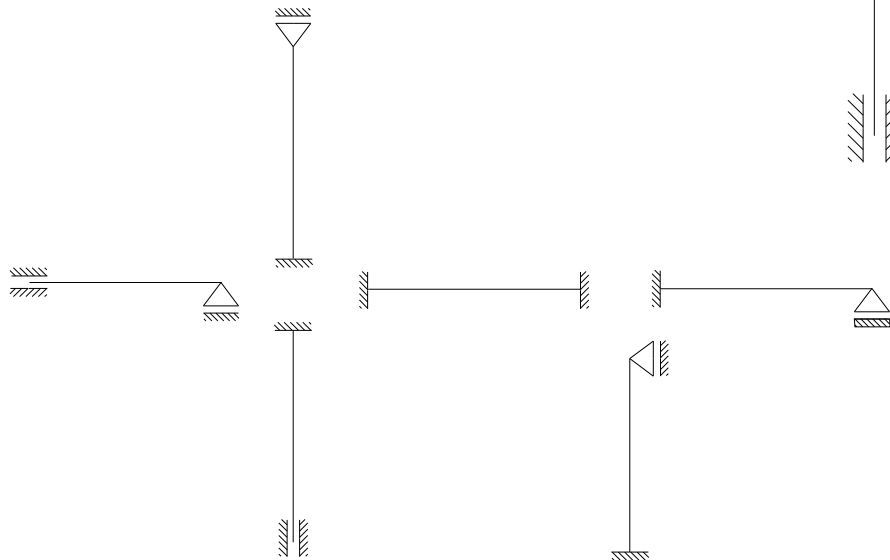
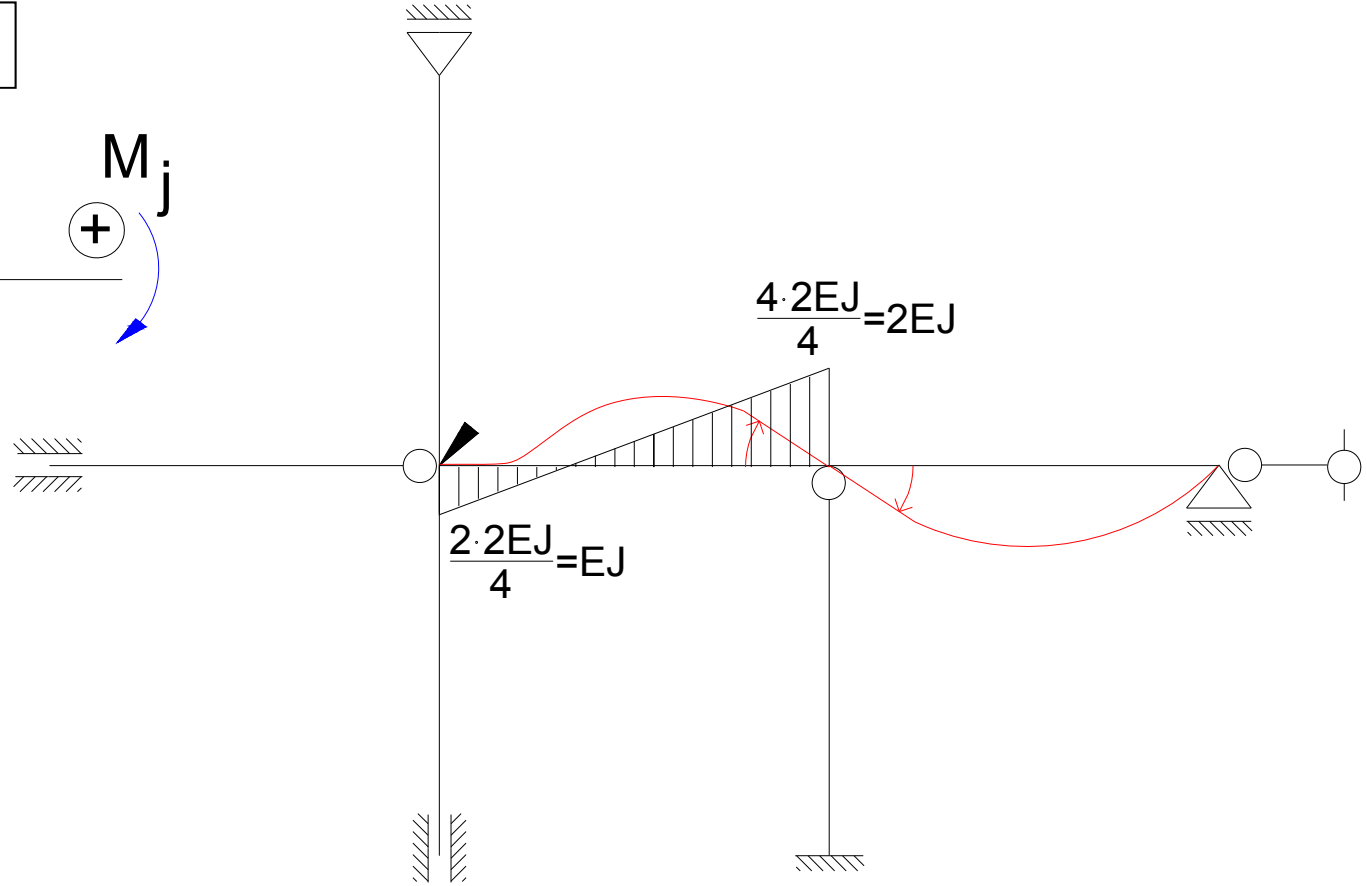
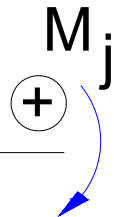
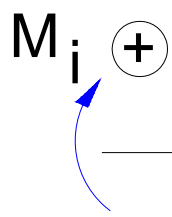

dr inž. Hanna Weber

Stan $\varphi_2=1$

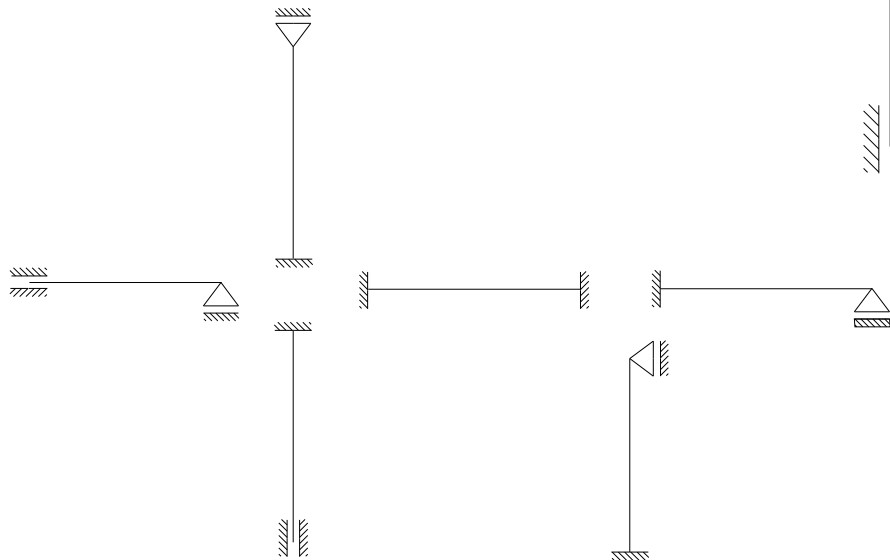
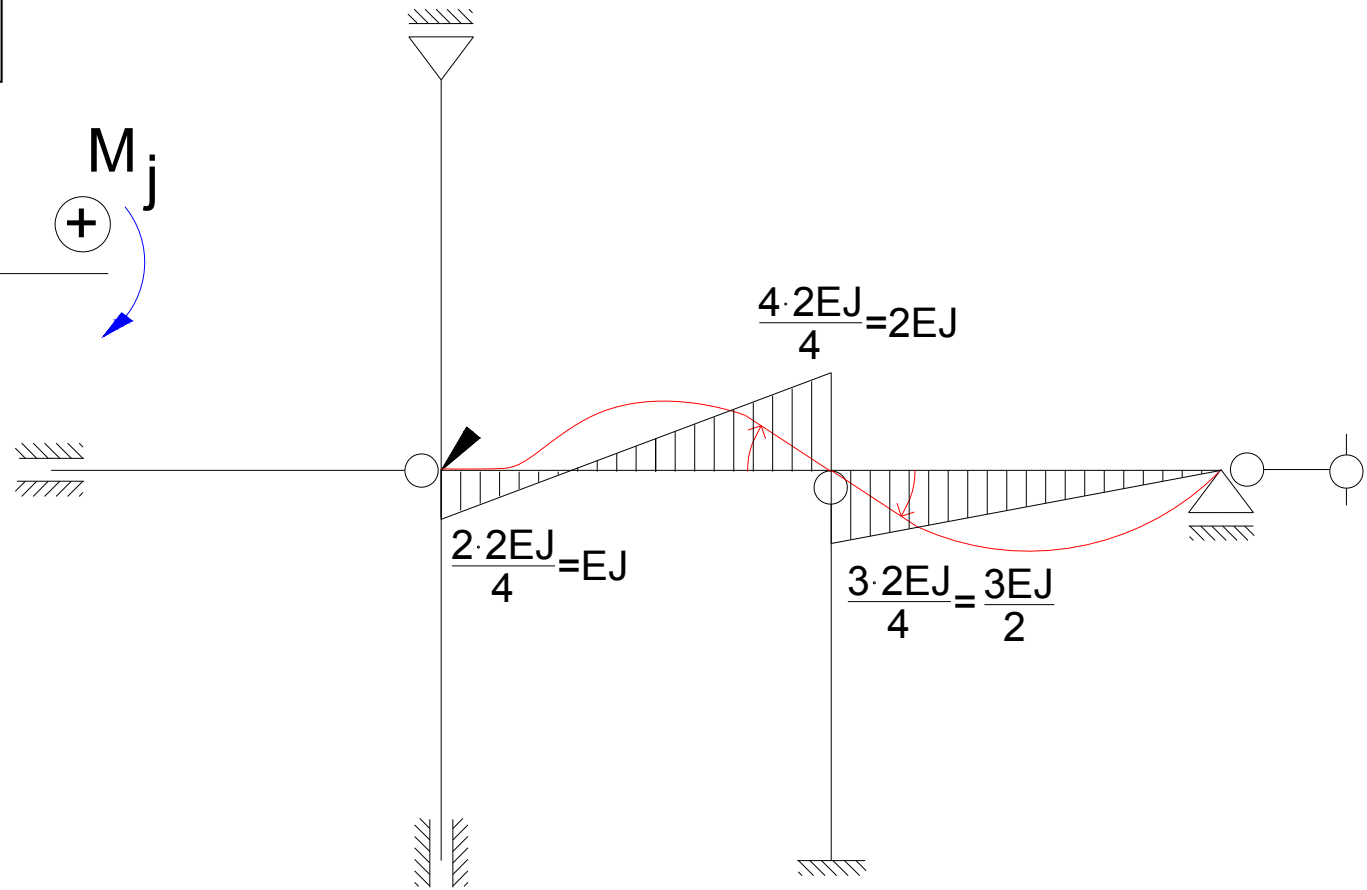
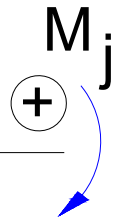
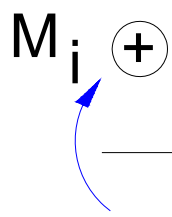

Stan $\varphi_2=1$

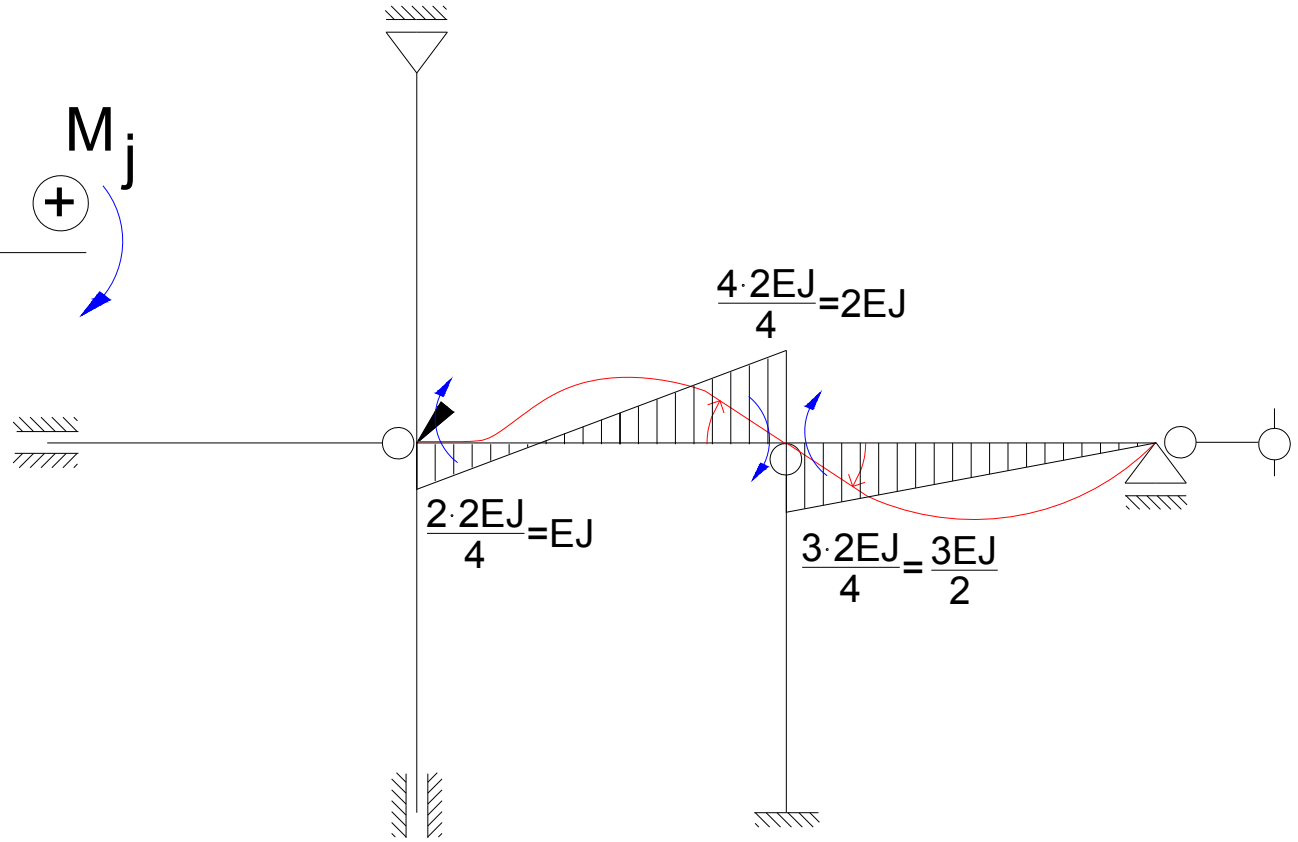
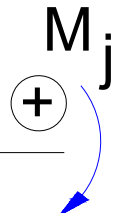
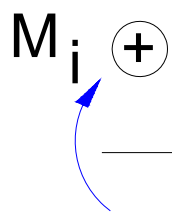

$k_{12} = EJ$

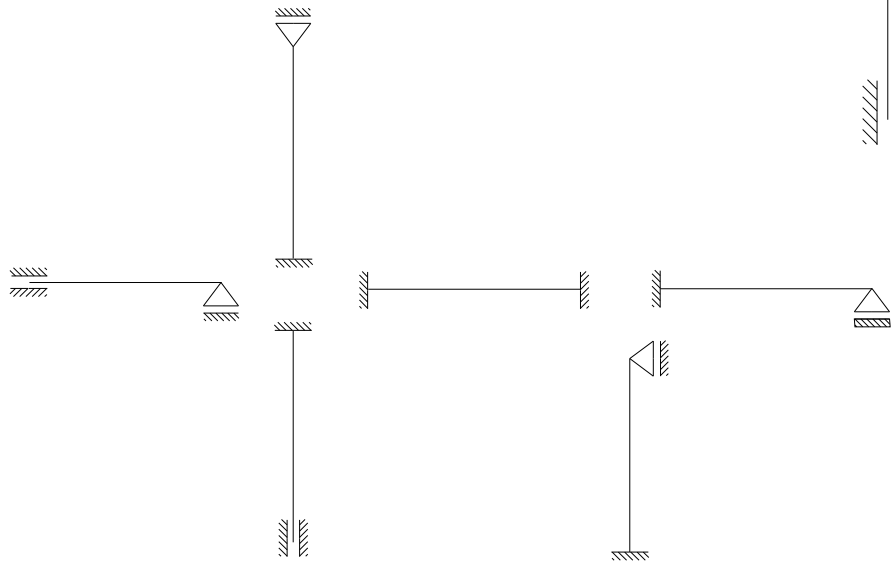

Stan $\varphi_2=1$

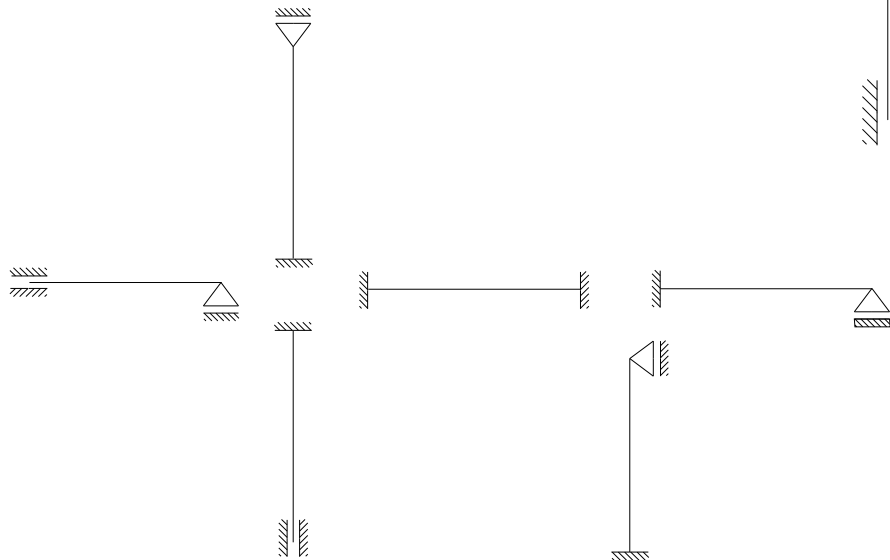
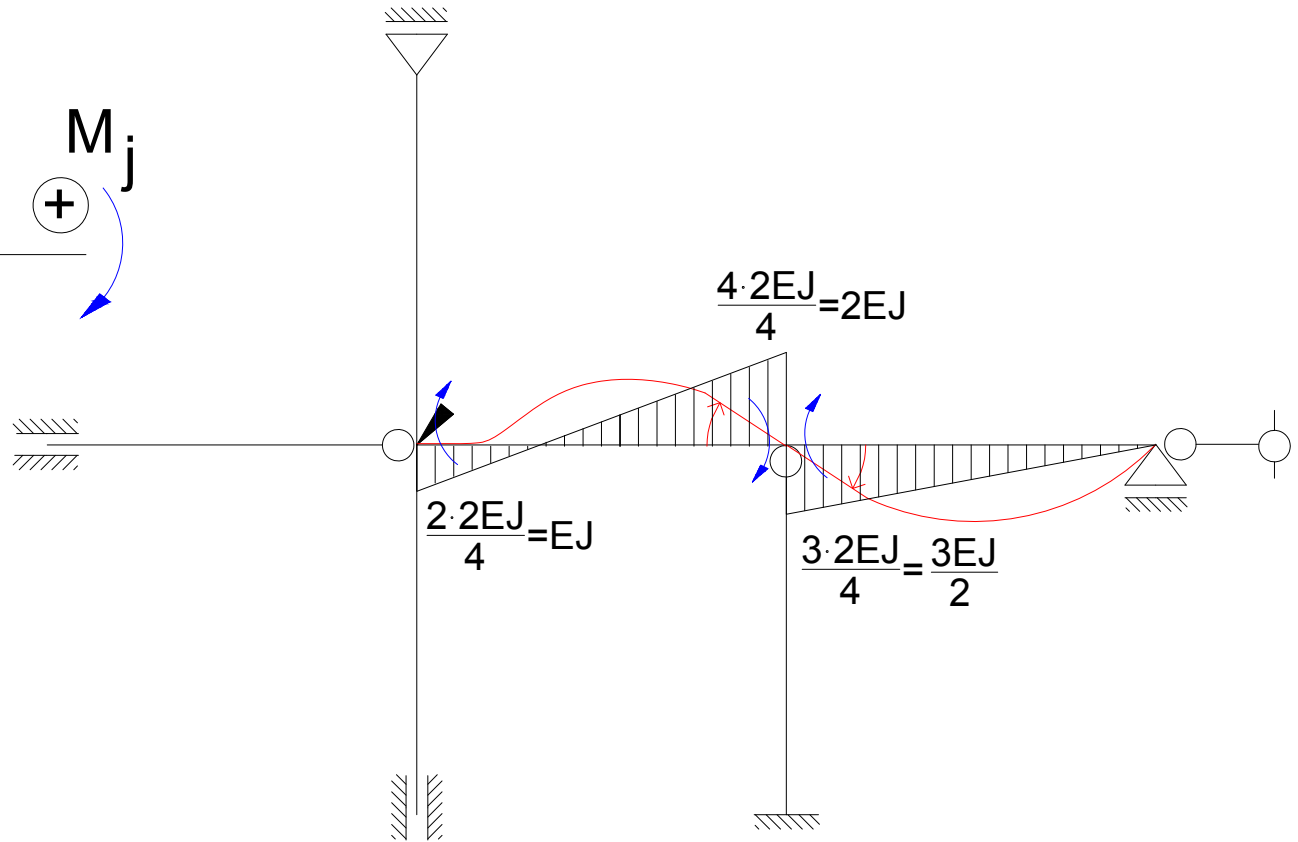

$$k_{12} = EJ$$

$$k_{22} = 2EJ + \frac{3EJ}{2} = \frac{7EJ}{2}$$

Stan $\Delta_3=1$

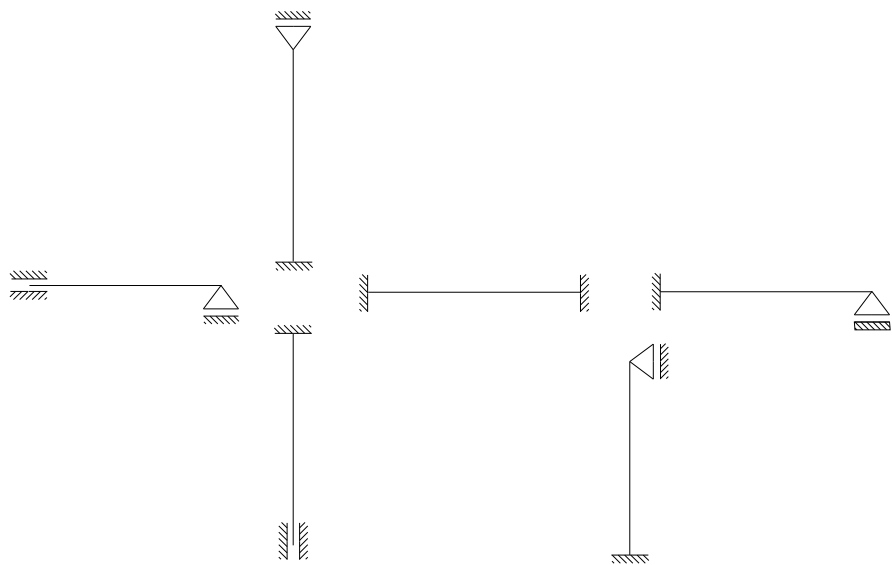
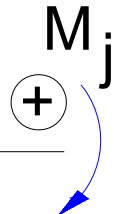
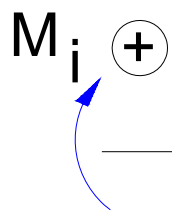

dr inž. Hanna Weber

Stan $\Delta_3=1$

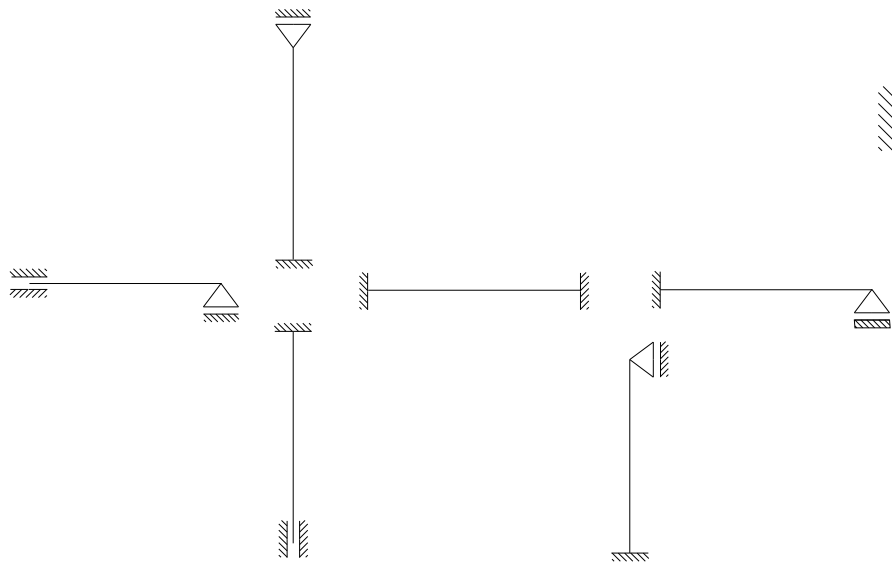
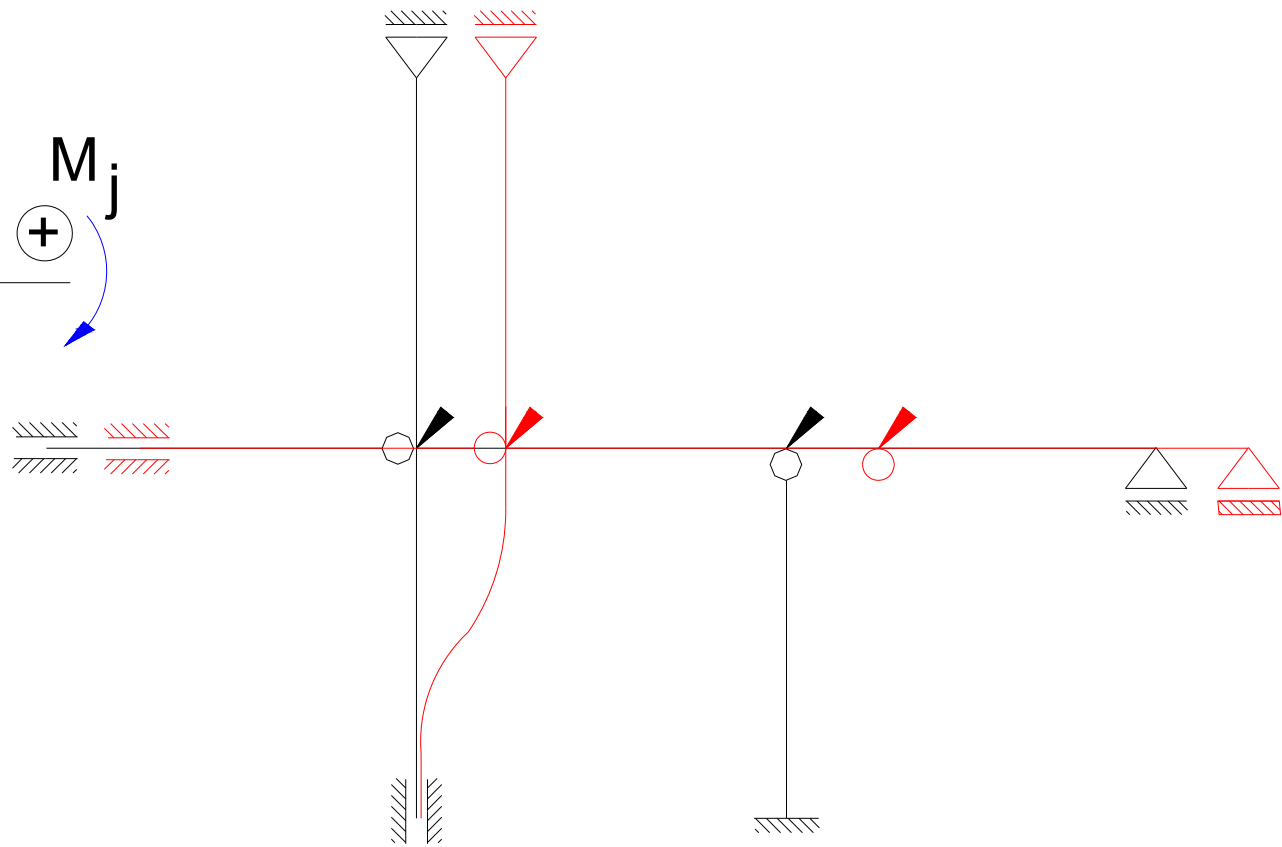
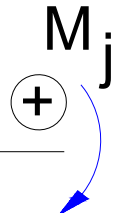
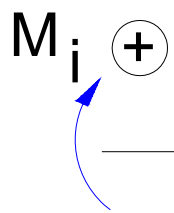

dr inž. Hanna Weber

Stan $\Delta_3=1$

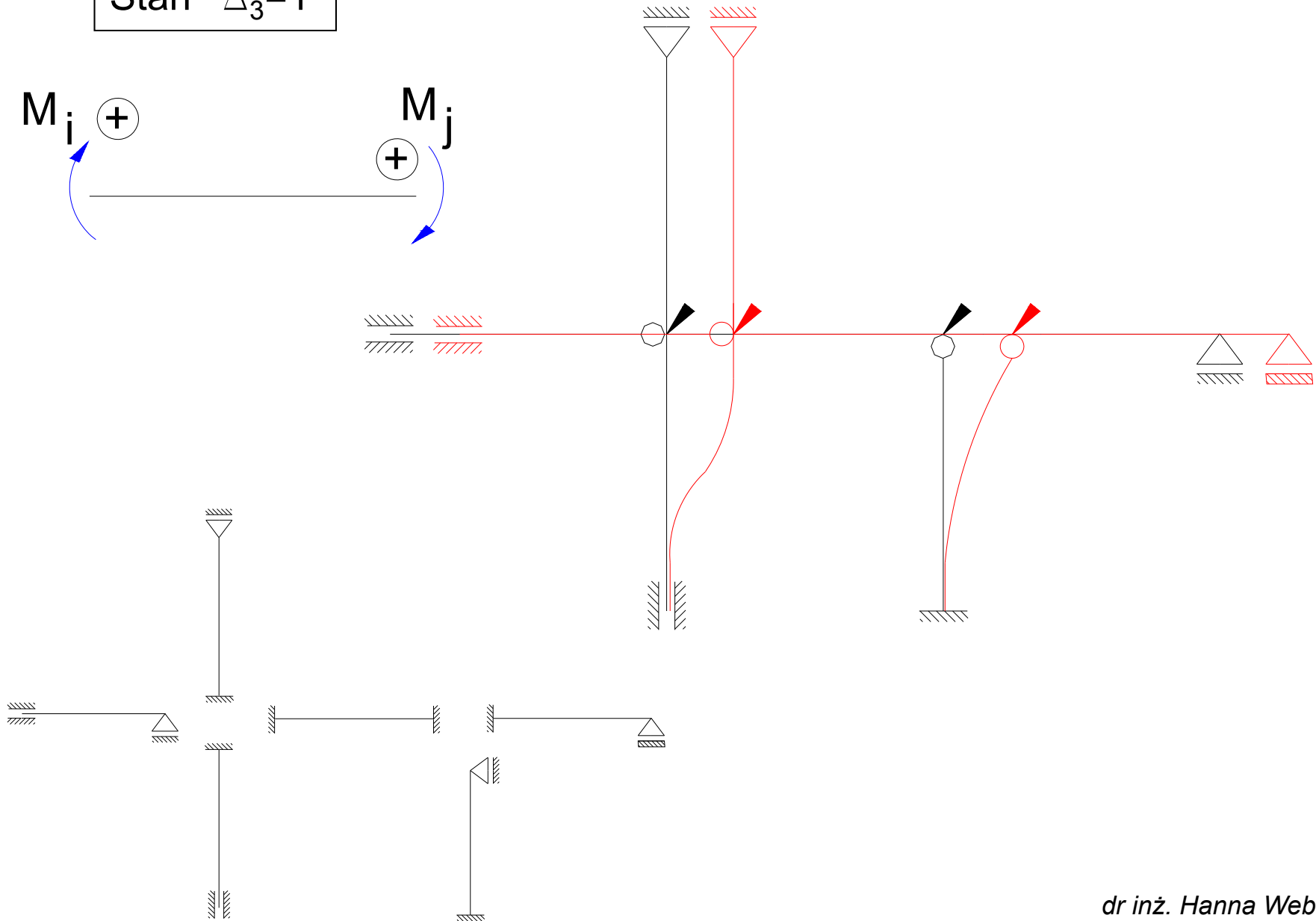
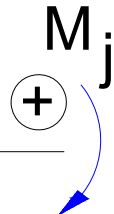
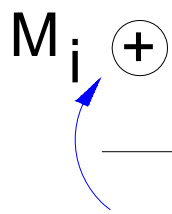

dr inž. Hanna Weber

Stan $\Delta_3=1$

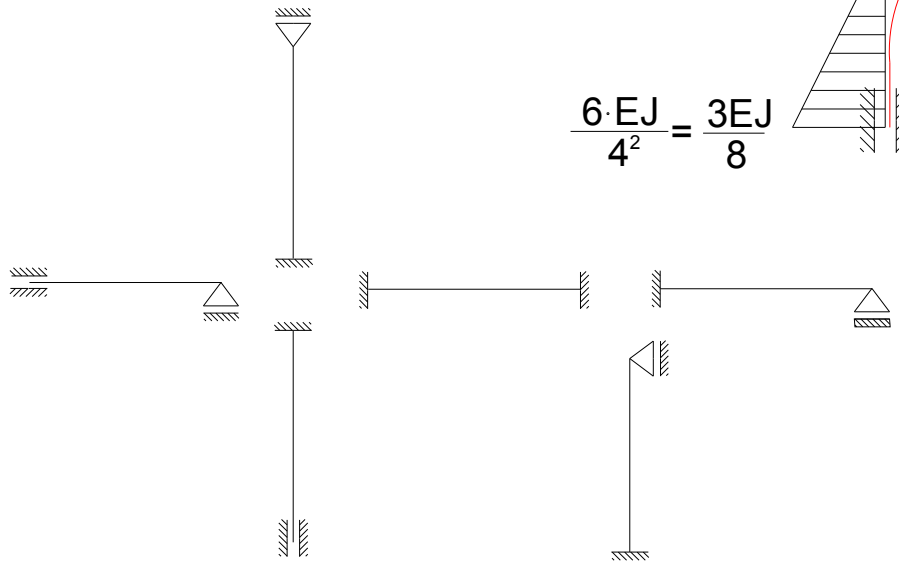
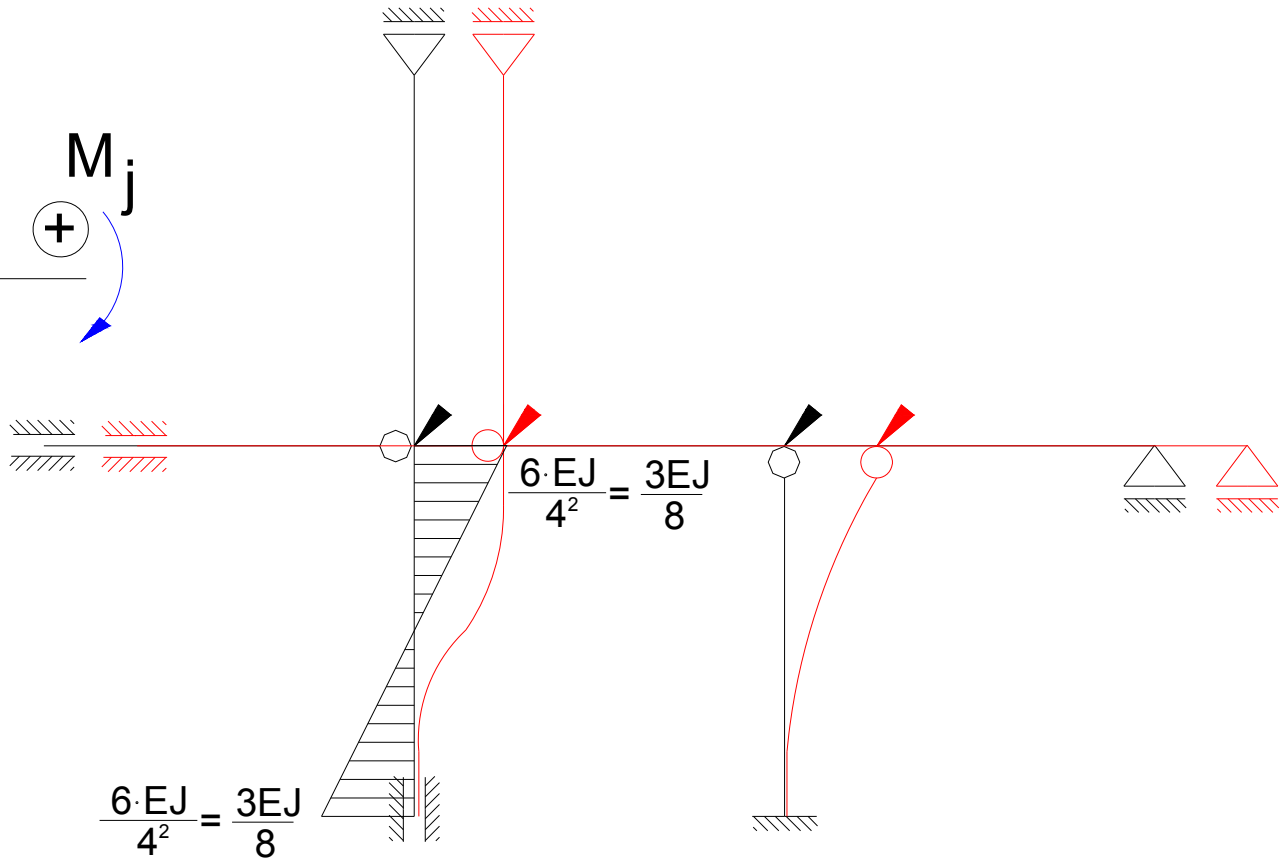
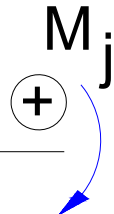
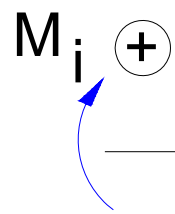

Stan $\Delta_3=1$

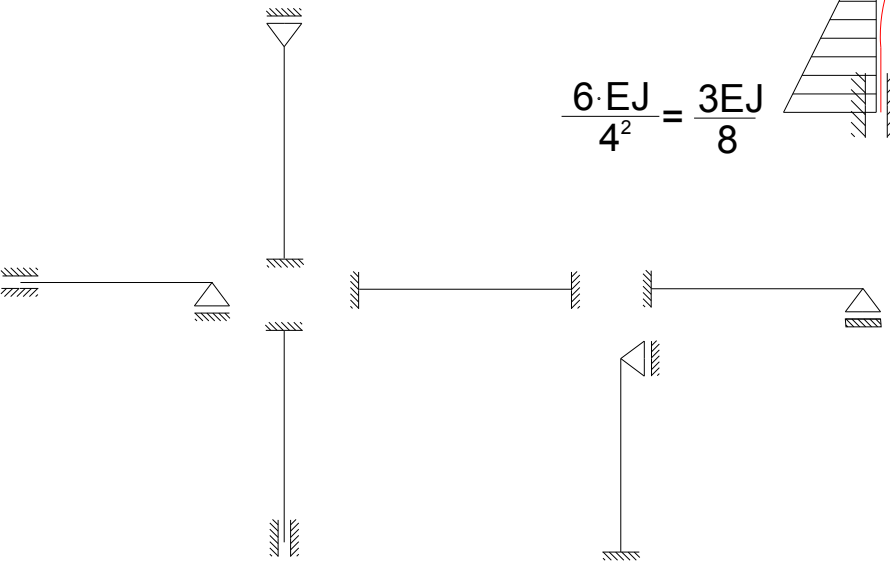
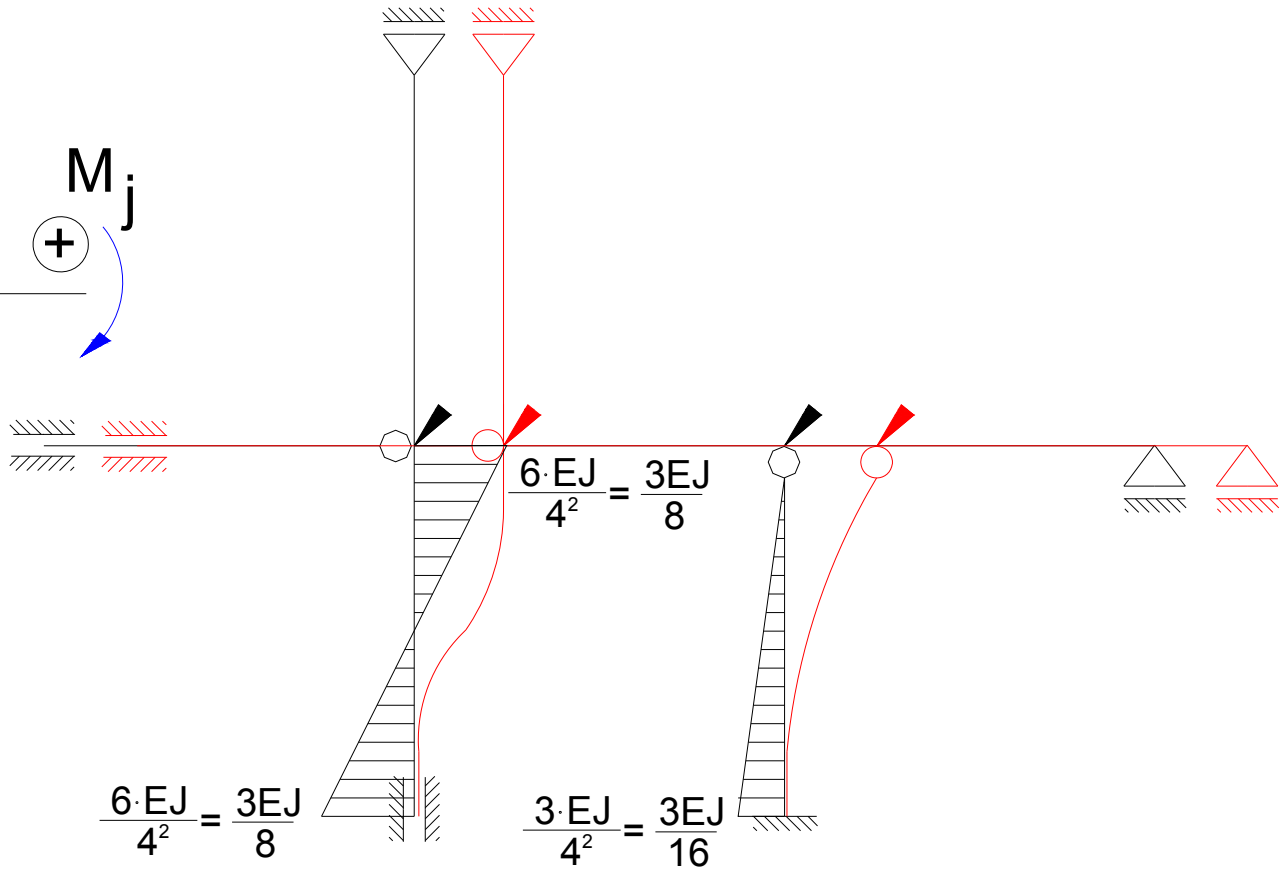
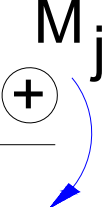
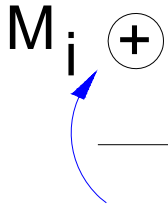

Stan $\Delta_3=1$

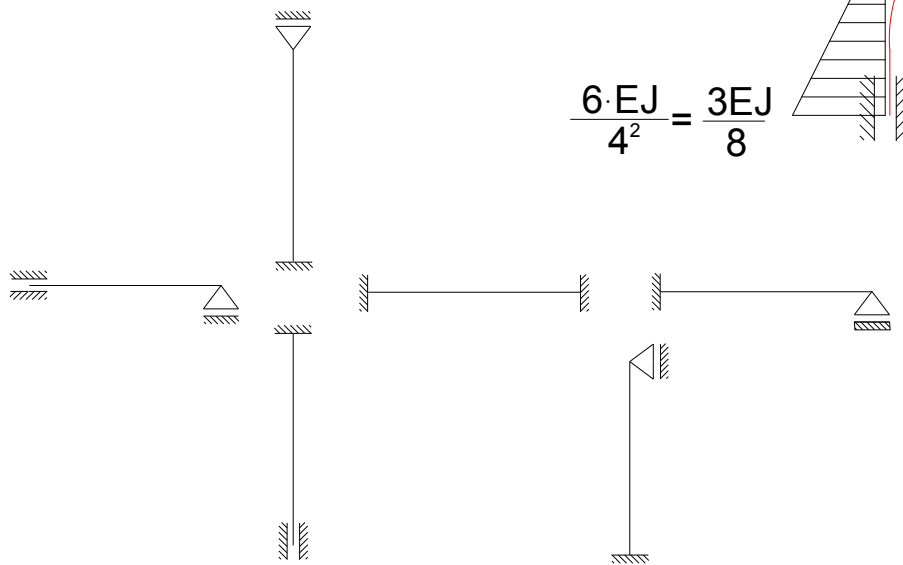
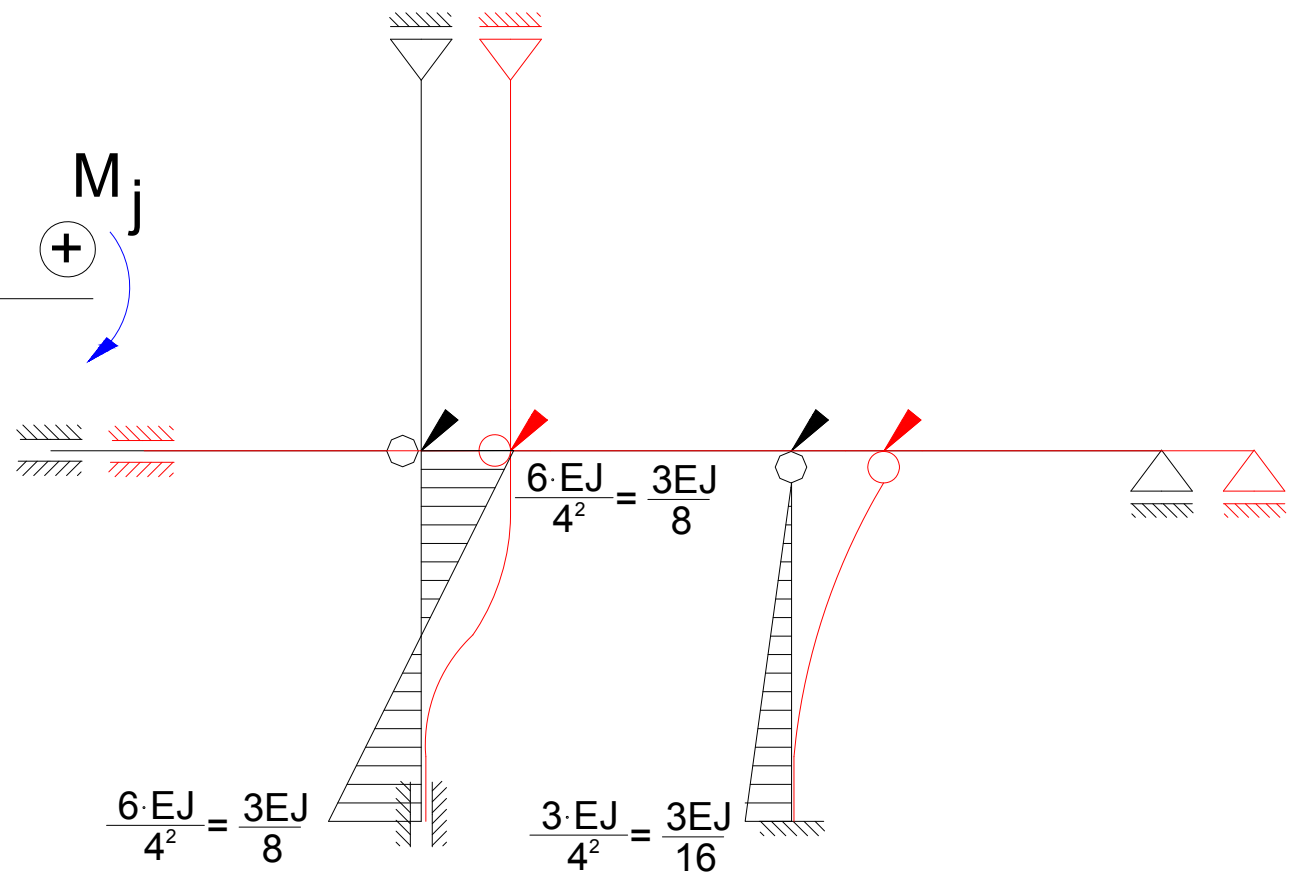
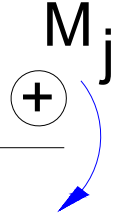
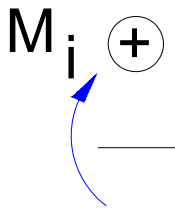

dr inž. Hanna Weber

Obciążenie zewnętrzne

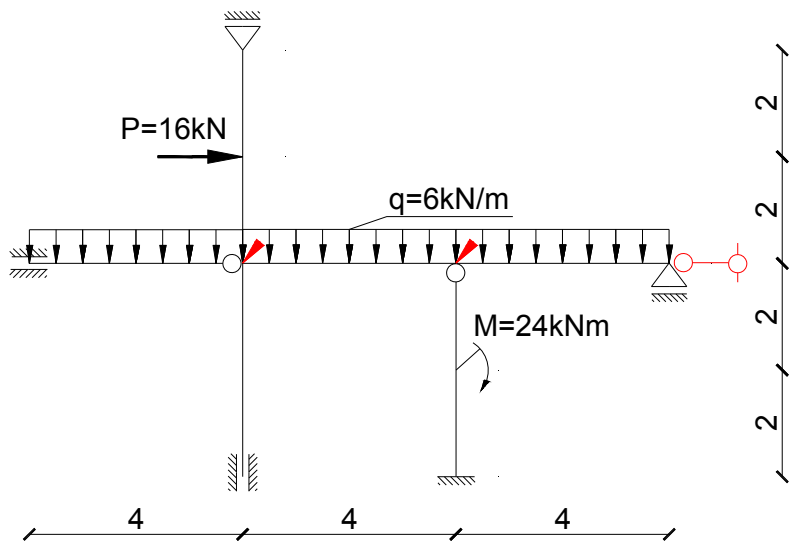

$$k_{10} = -32 - 8 = -40kNm$$

$$k_{20} = 8 - 12 = -4kNm$$

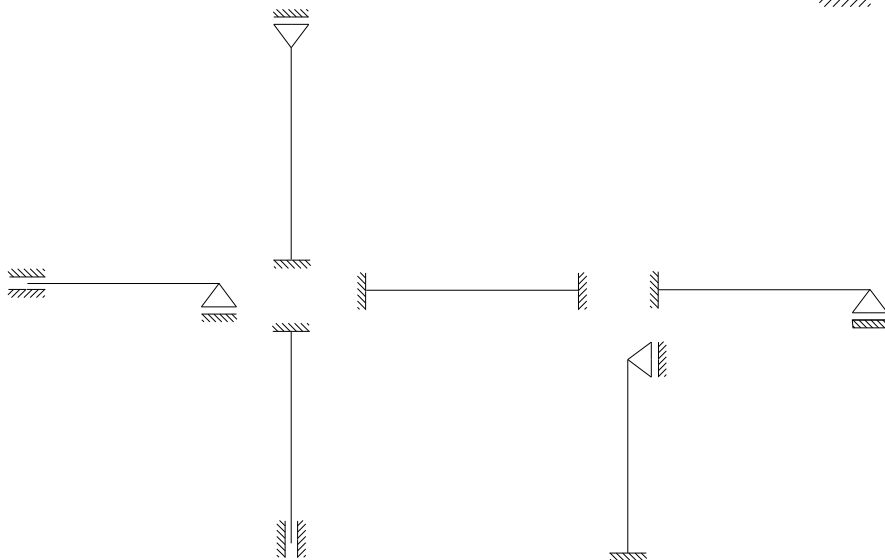
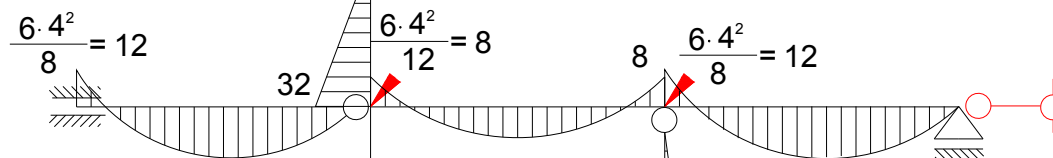

$$\frac{64}{2} \left[1 - 3 \left(\frac{2}{4} \right)^2 \right] = 8$$

Wyznaczenie współczynników od reakcji

$$\varphi_1 = 1$$

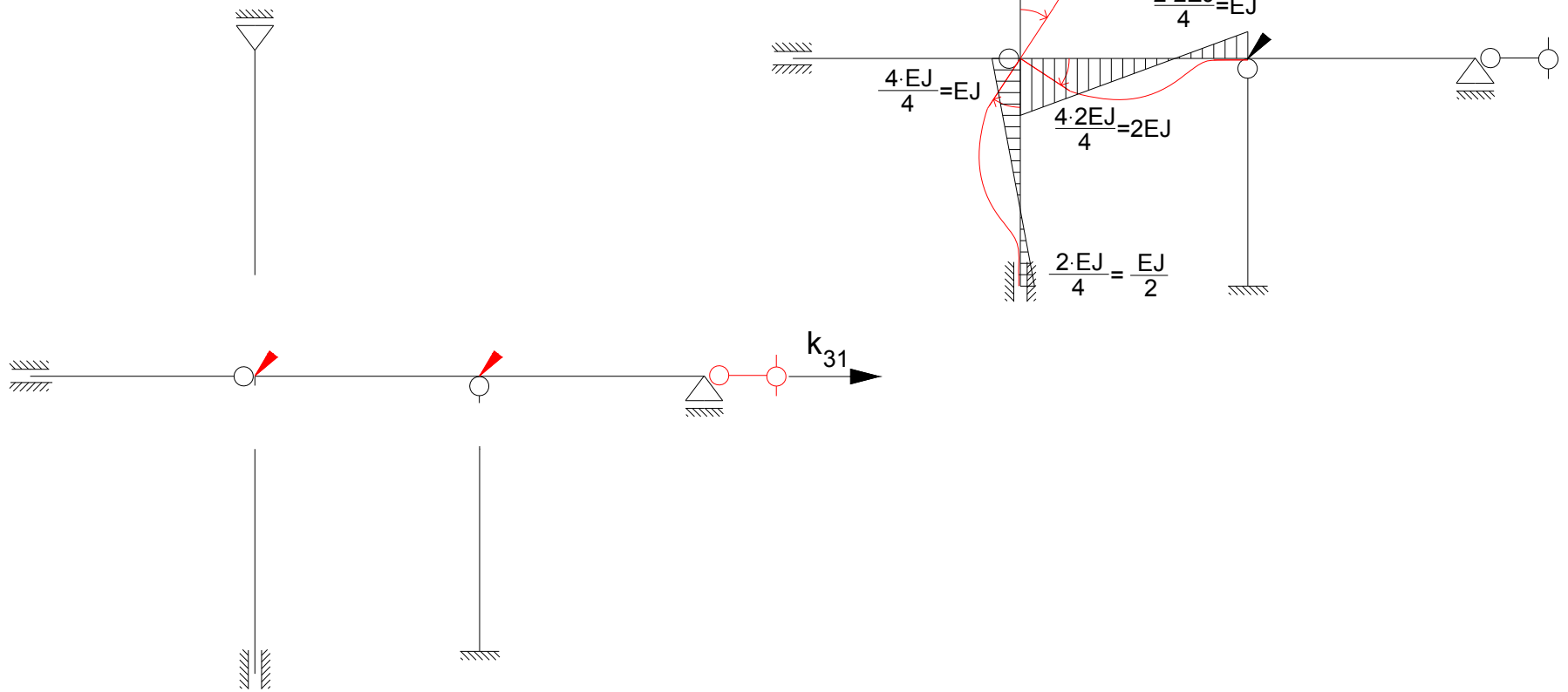

Wyznaczenie współczynników od reakcji

$$\varphi_1 = 1$$

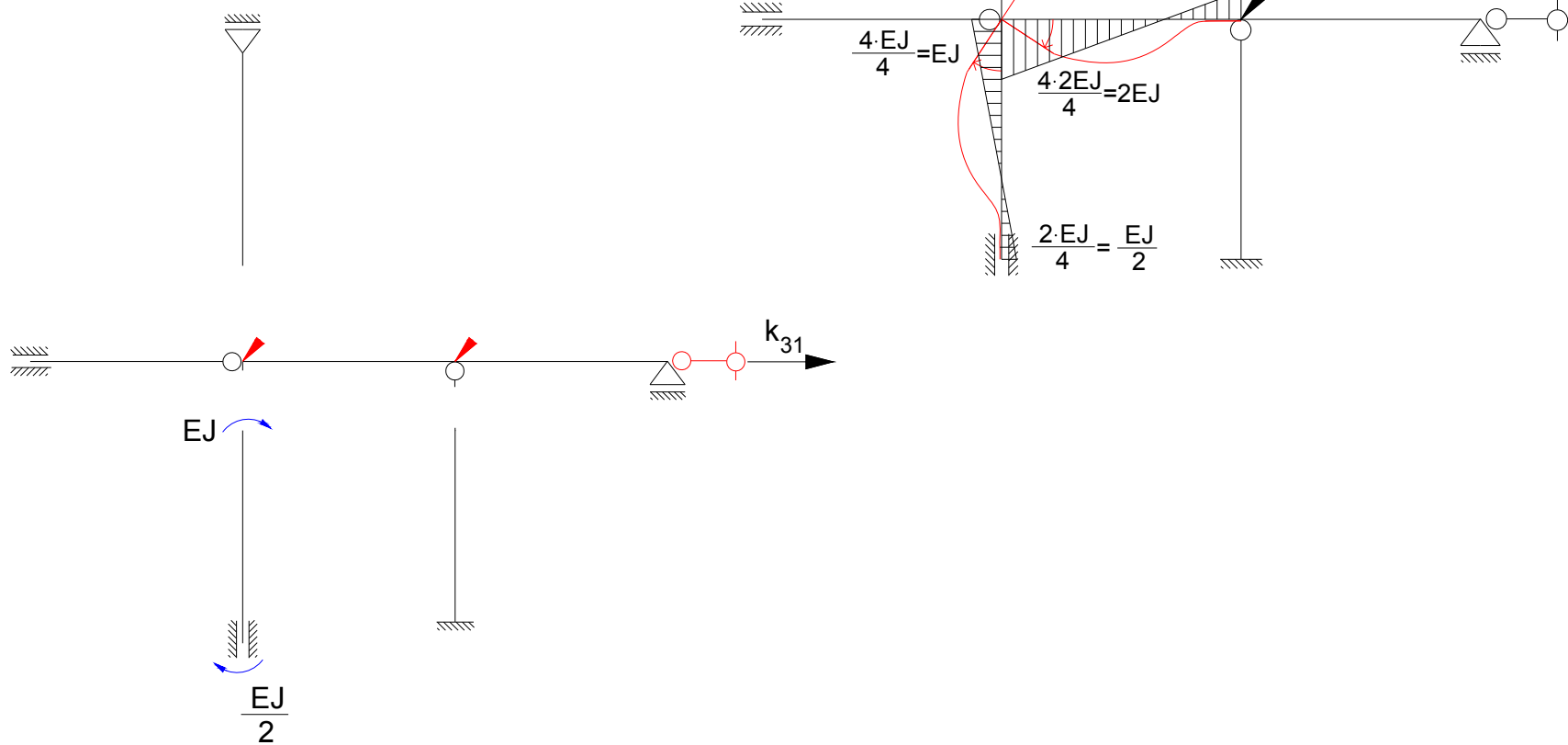

Wyznaczenie współczynników od reakcji

$$\varphi_1 = 1$$

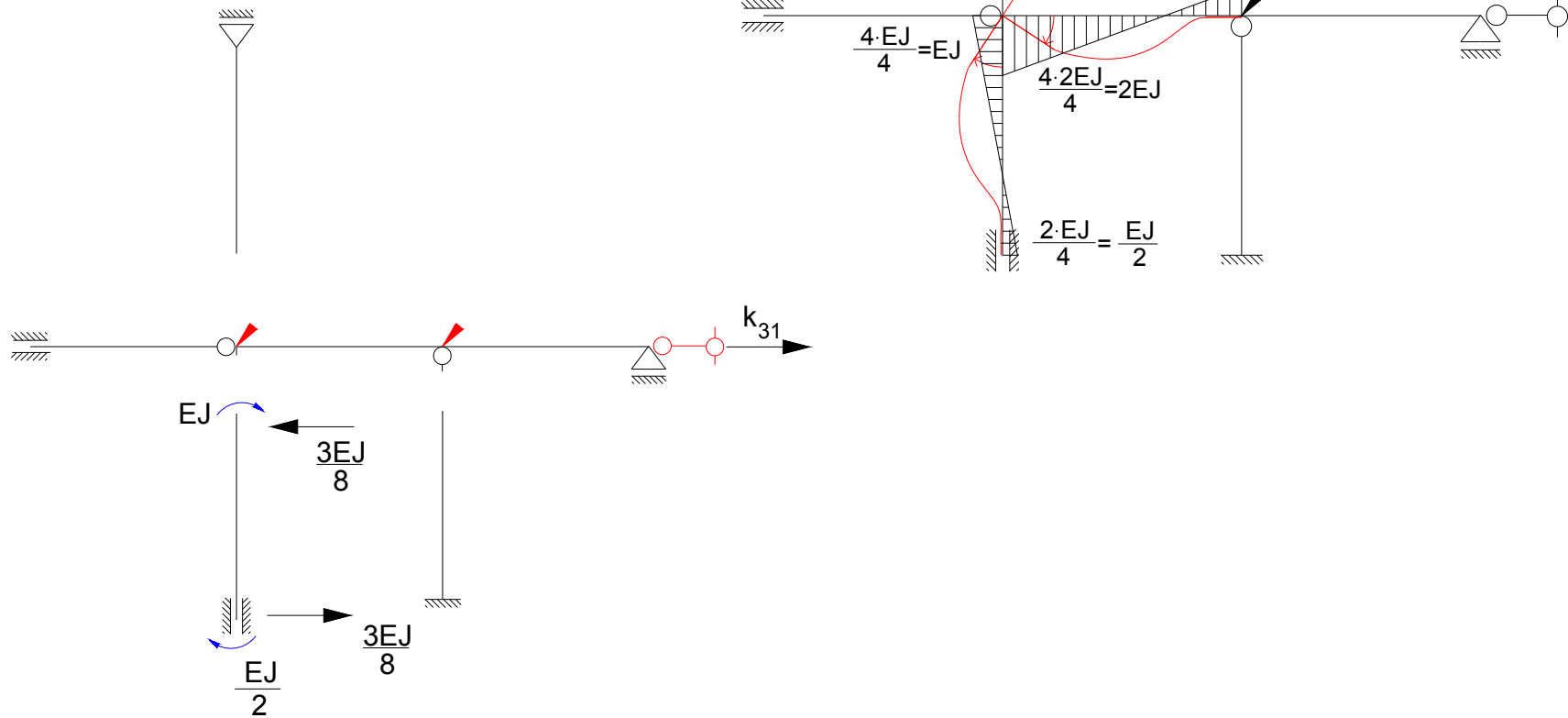

Wyznaczenie współczynników od reakcji

$$\varphi_1 = 1$$

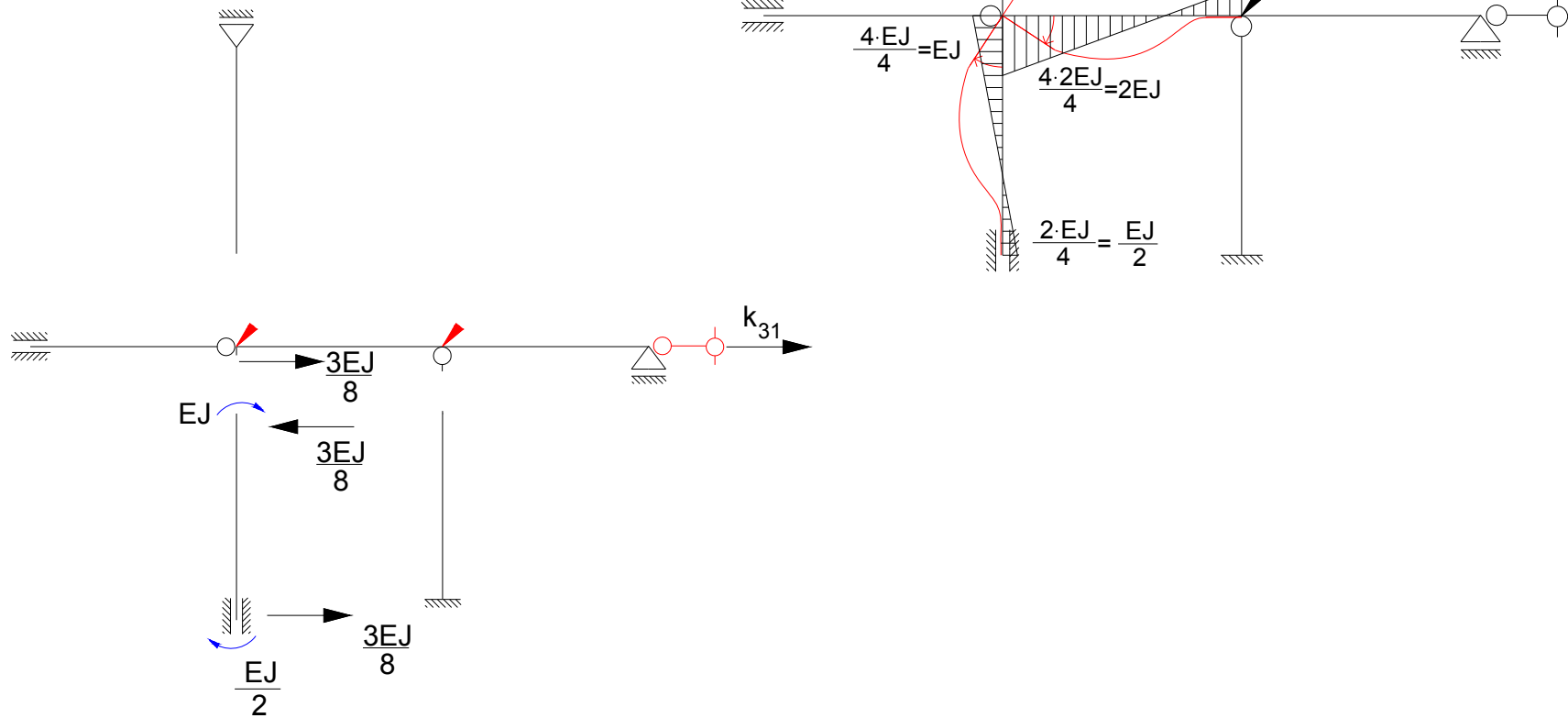

Wyznaczenie współczynników od reakcji

$$\varphi_1 = 1$$

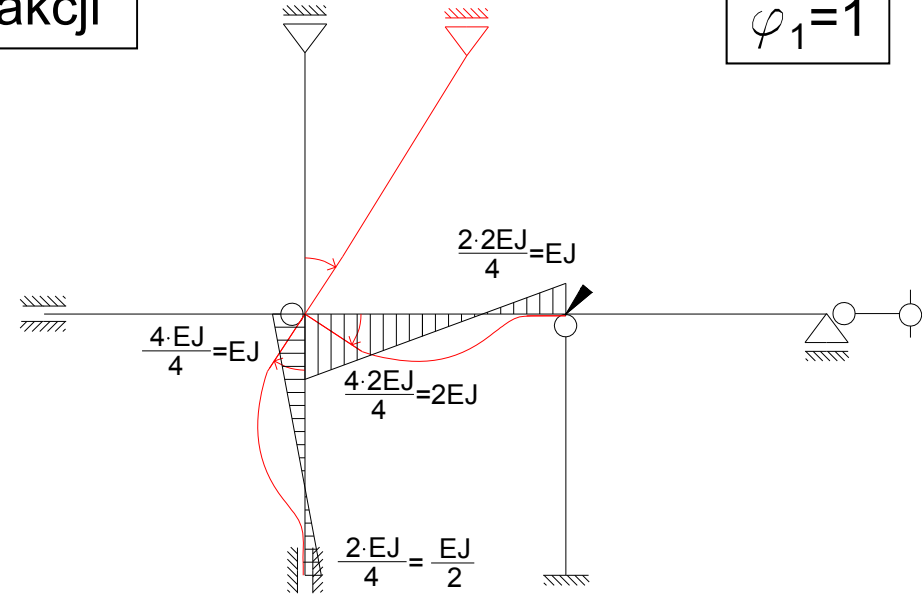
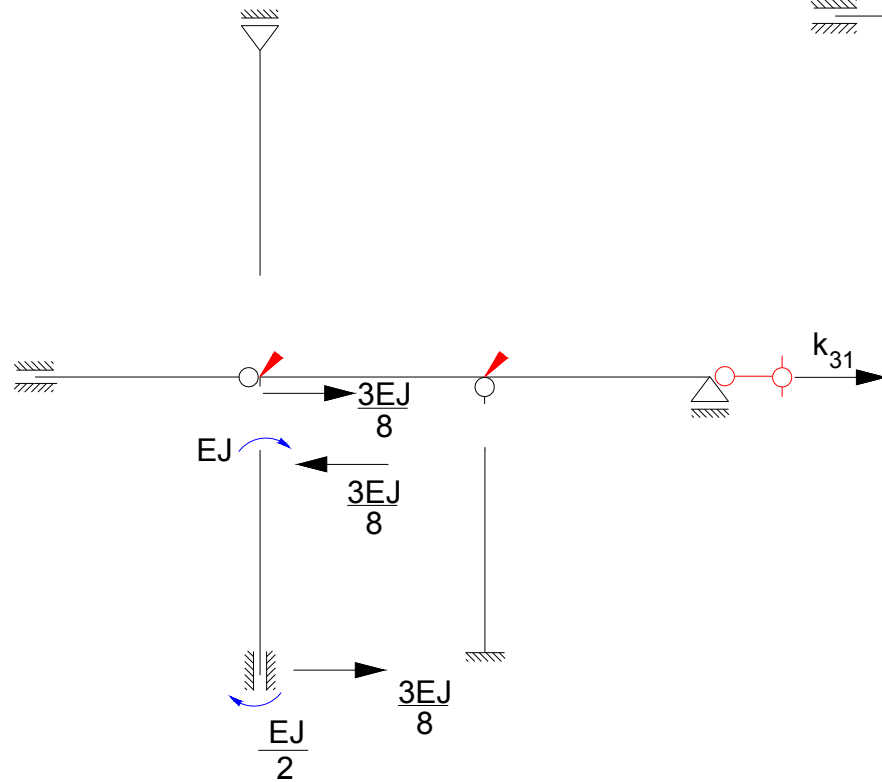

$$\sum R_x = \frac{3EJ}{8} + k_{31} = 0 \rightarrow k_{31} = -\frac{3EJ}{8}$$

Wyznaczenie współczynników od reakcji

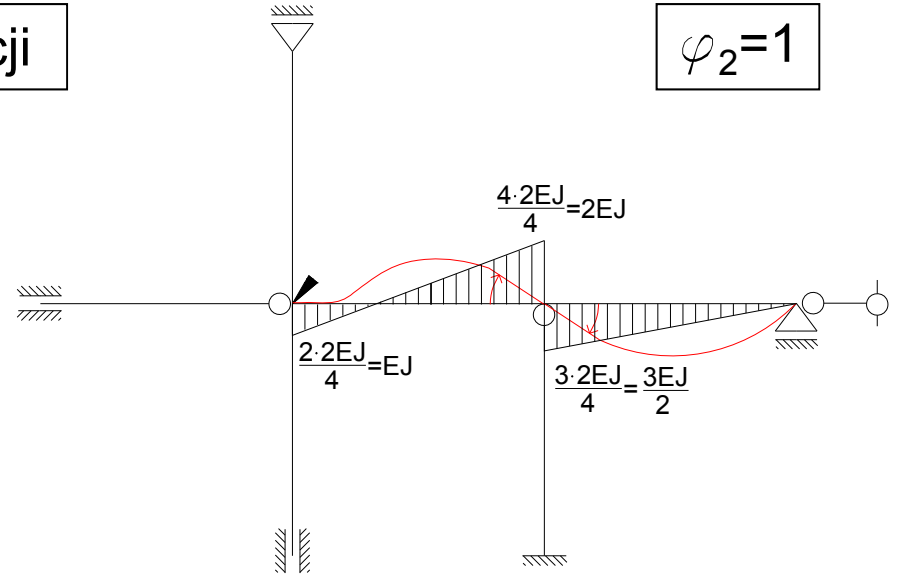
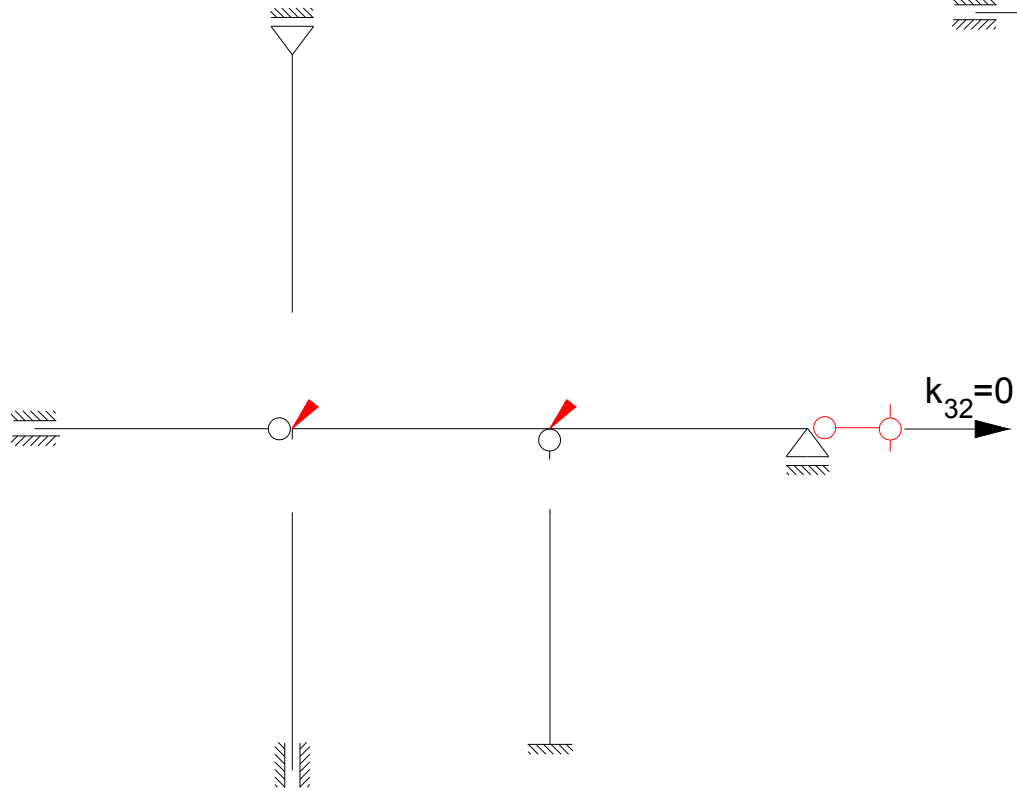

Wyznaczenie współczynników od reakcji

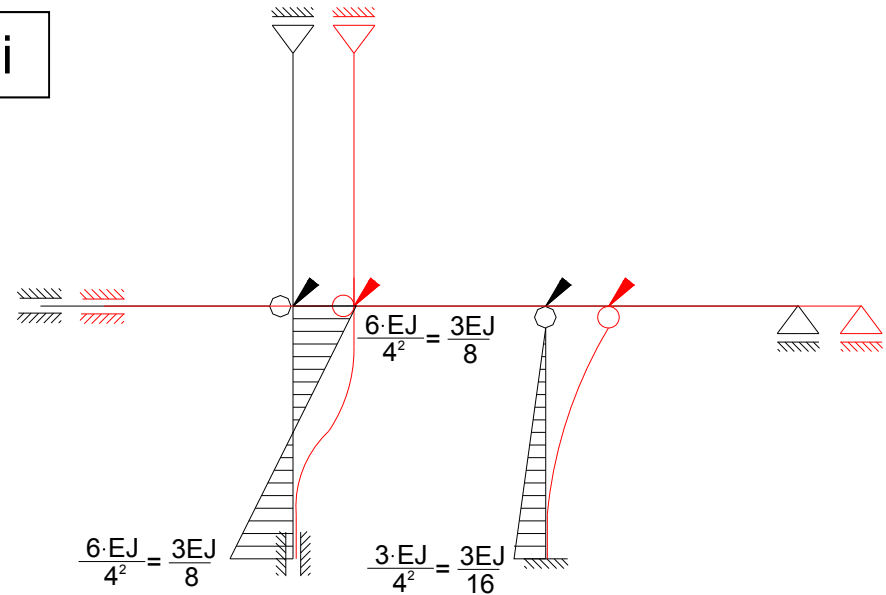
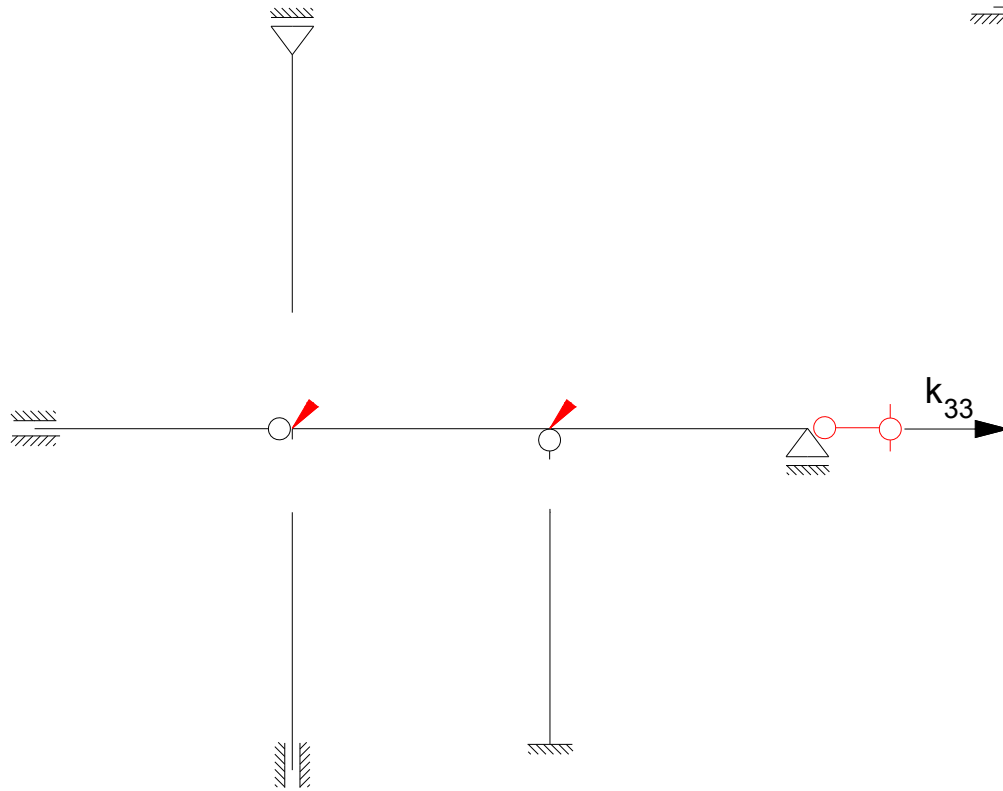

Wyznaczenie współczynników od reakcji

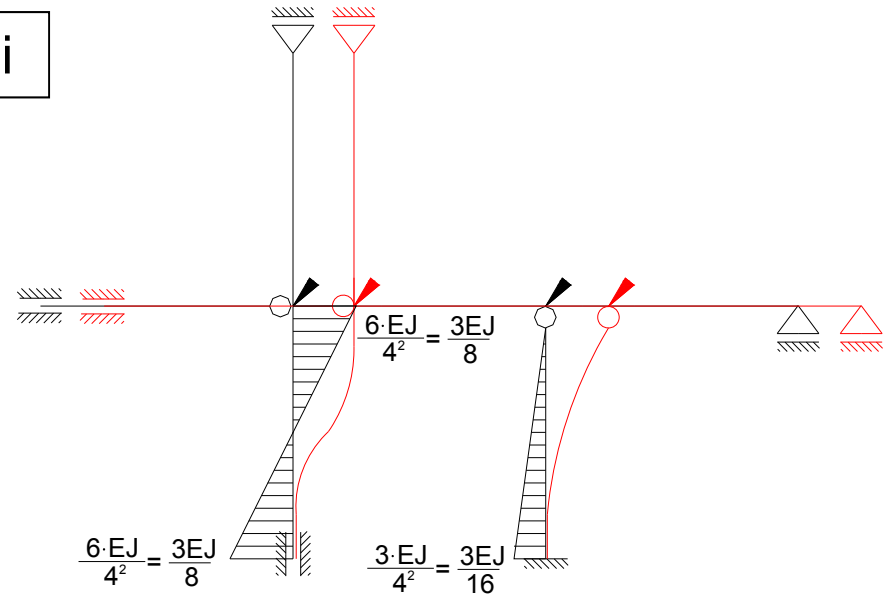
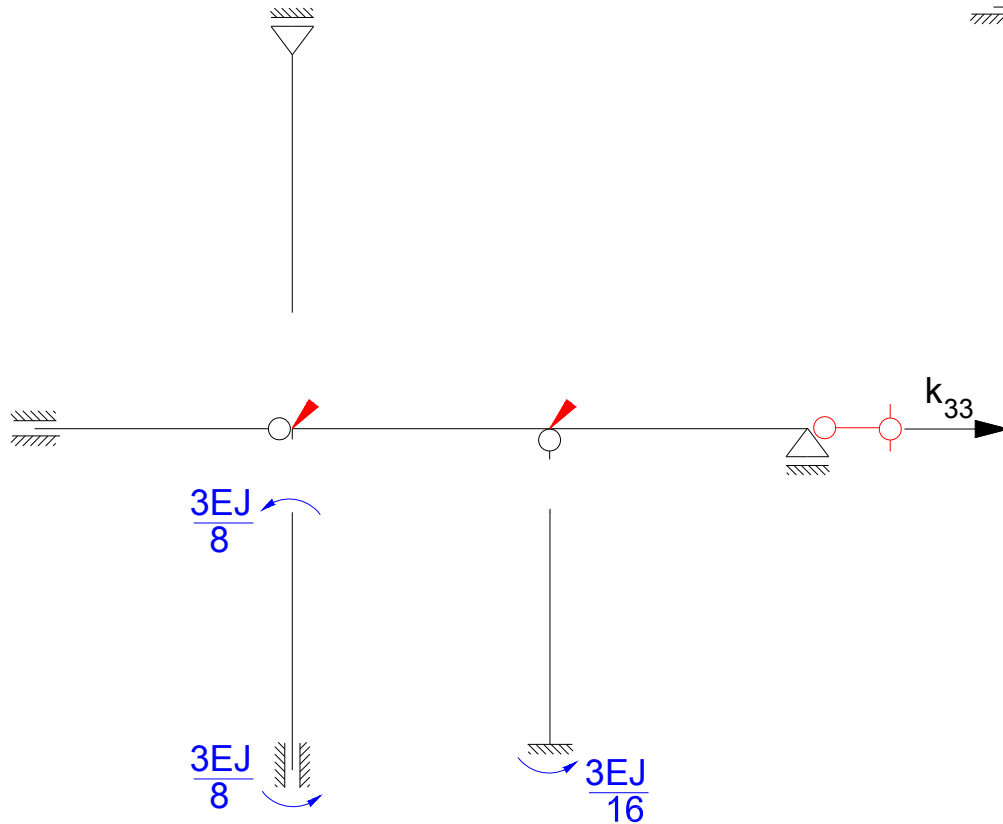

Wyznaczenie współczynników od reakcji

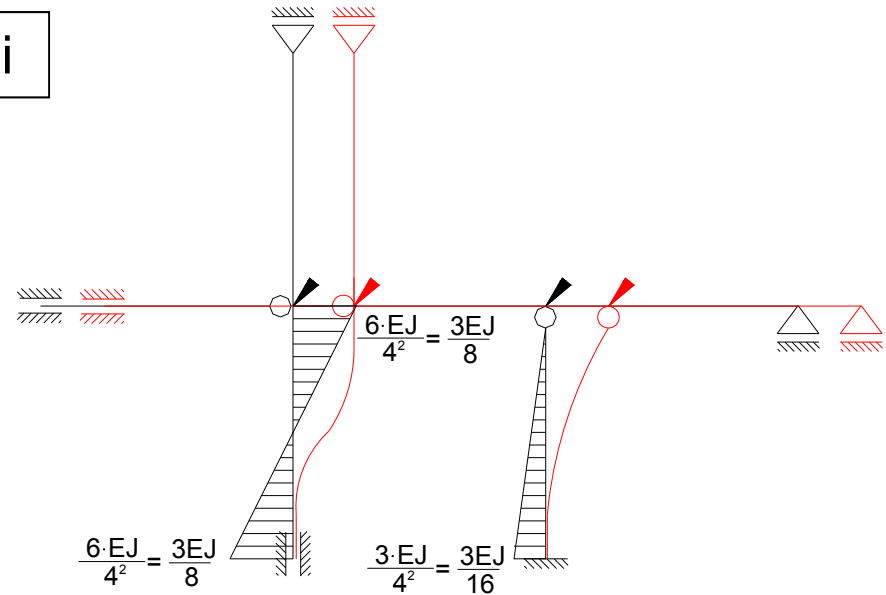
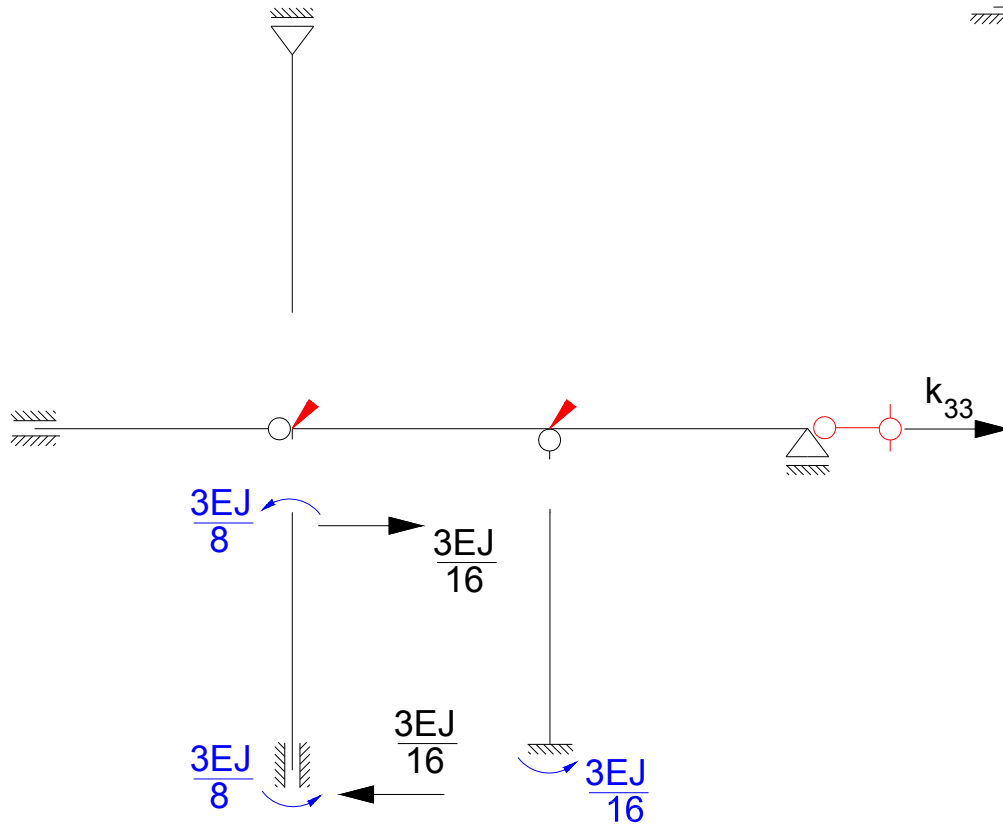

Wyznaczenie współczynników od reakcji

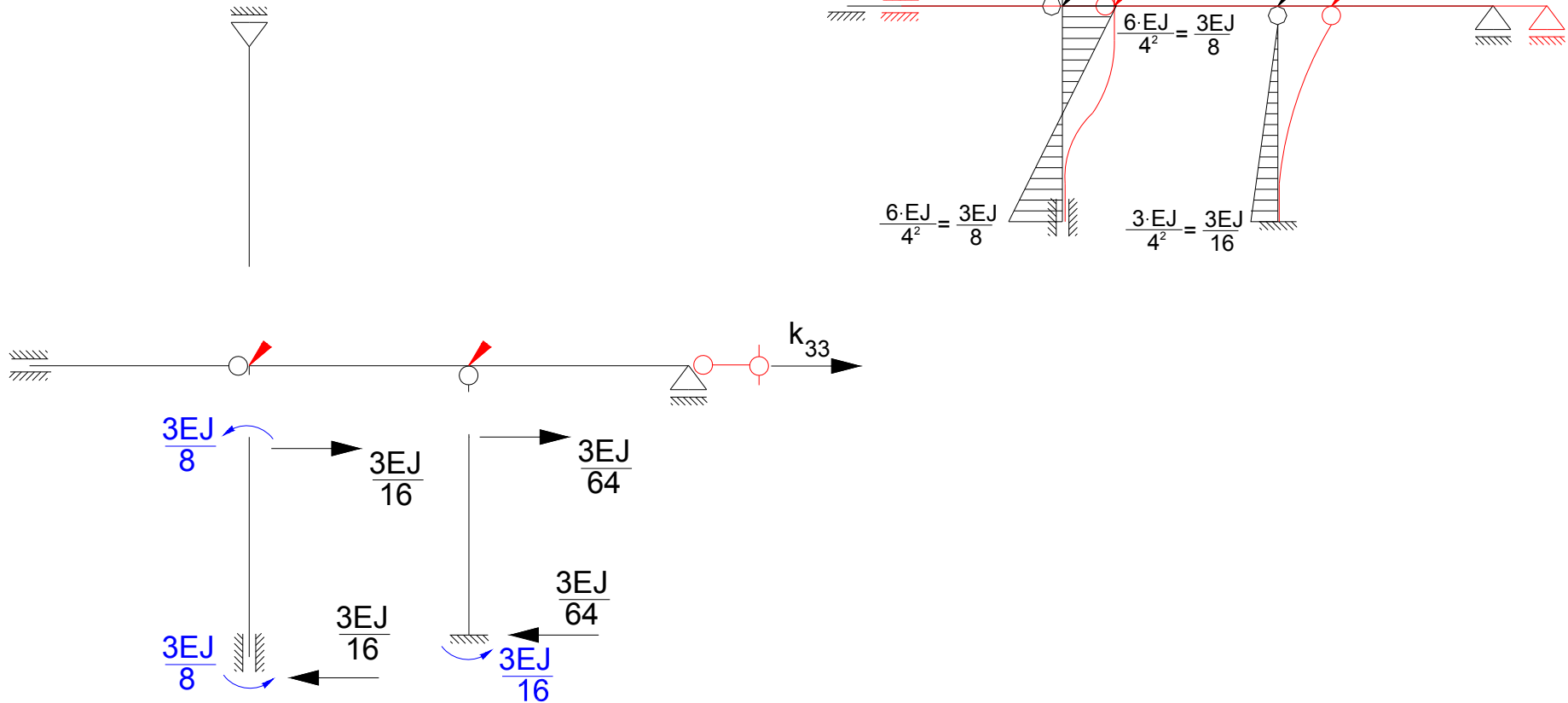

Wyznaczenie współczynników od reakcji

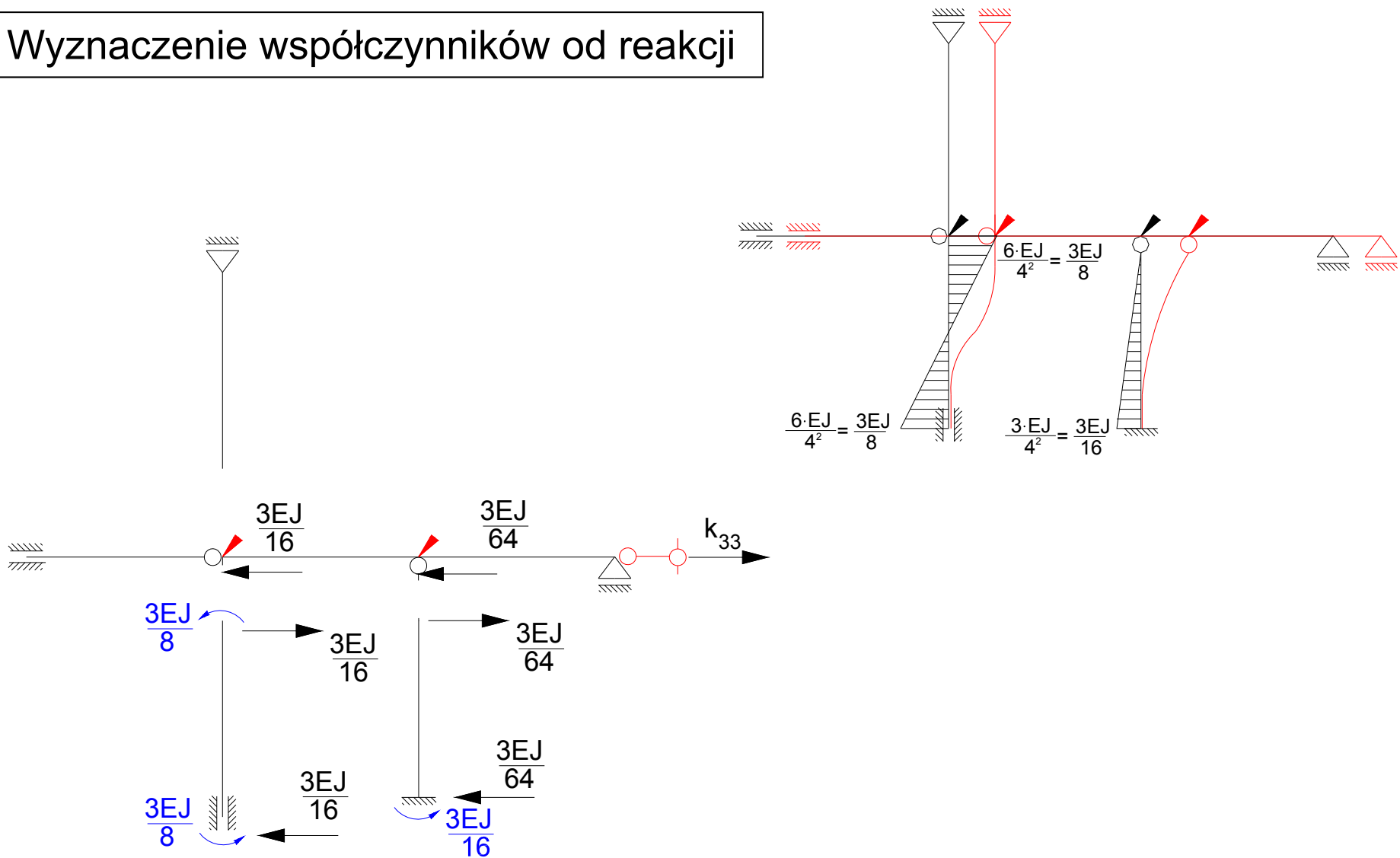

Wyznaczenie współczynników od reakcji

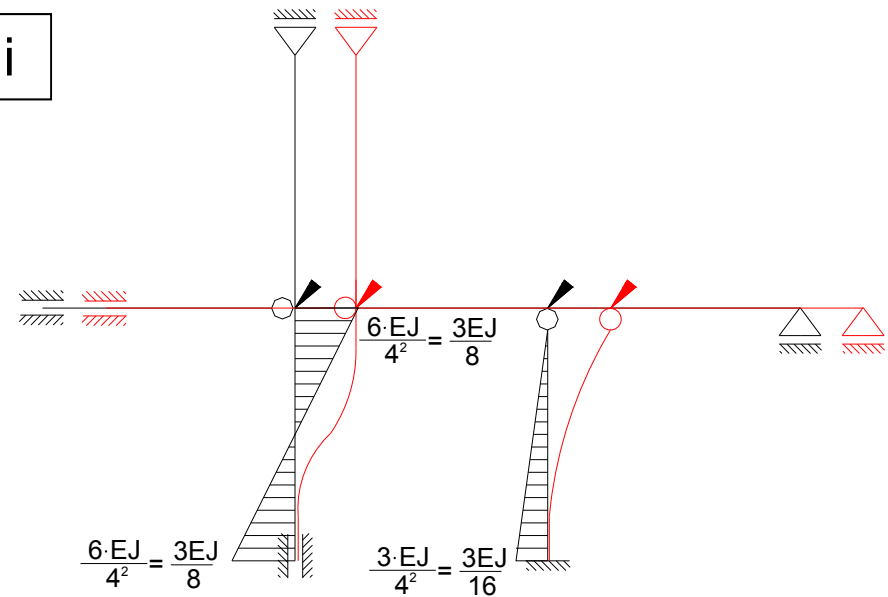
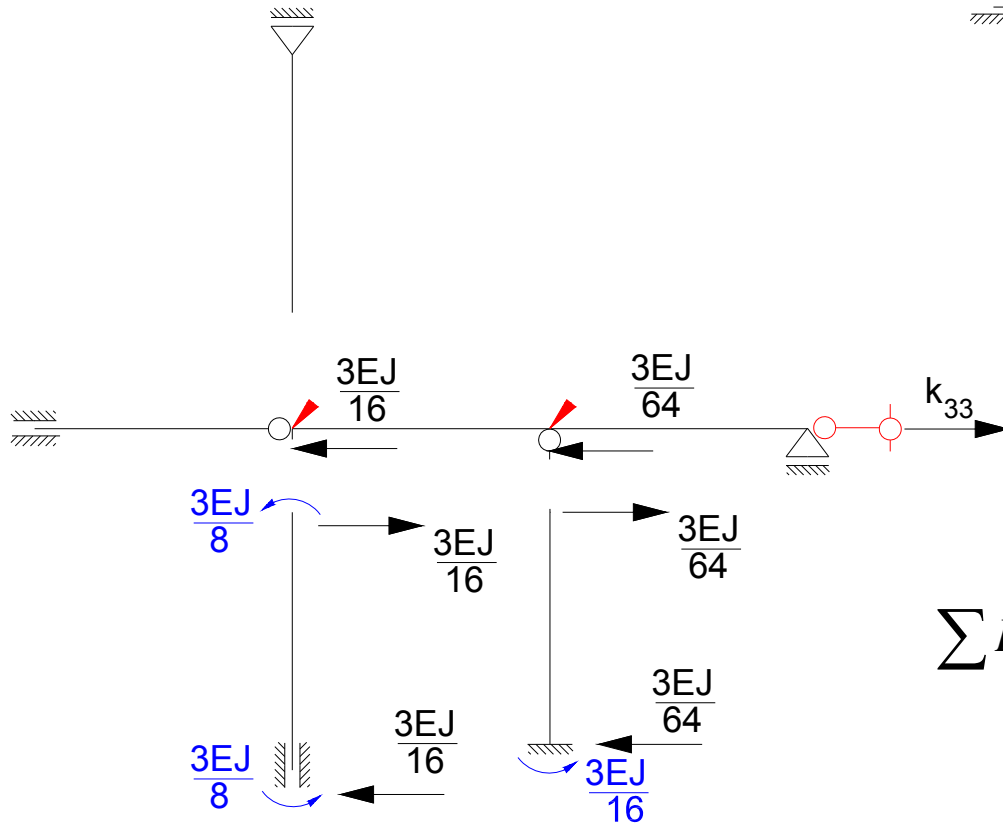

$$\sum R_x = -\frac{3EJ}{16} - \frac{3EJ}{64} + k_{33} = 0 \rightarrow k_{33} = \frac{15EJ}{64}$$

Wyznaczenie współczynników od reakcji

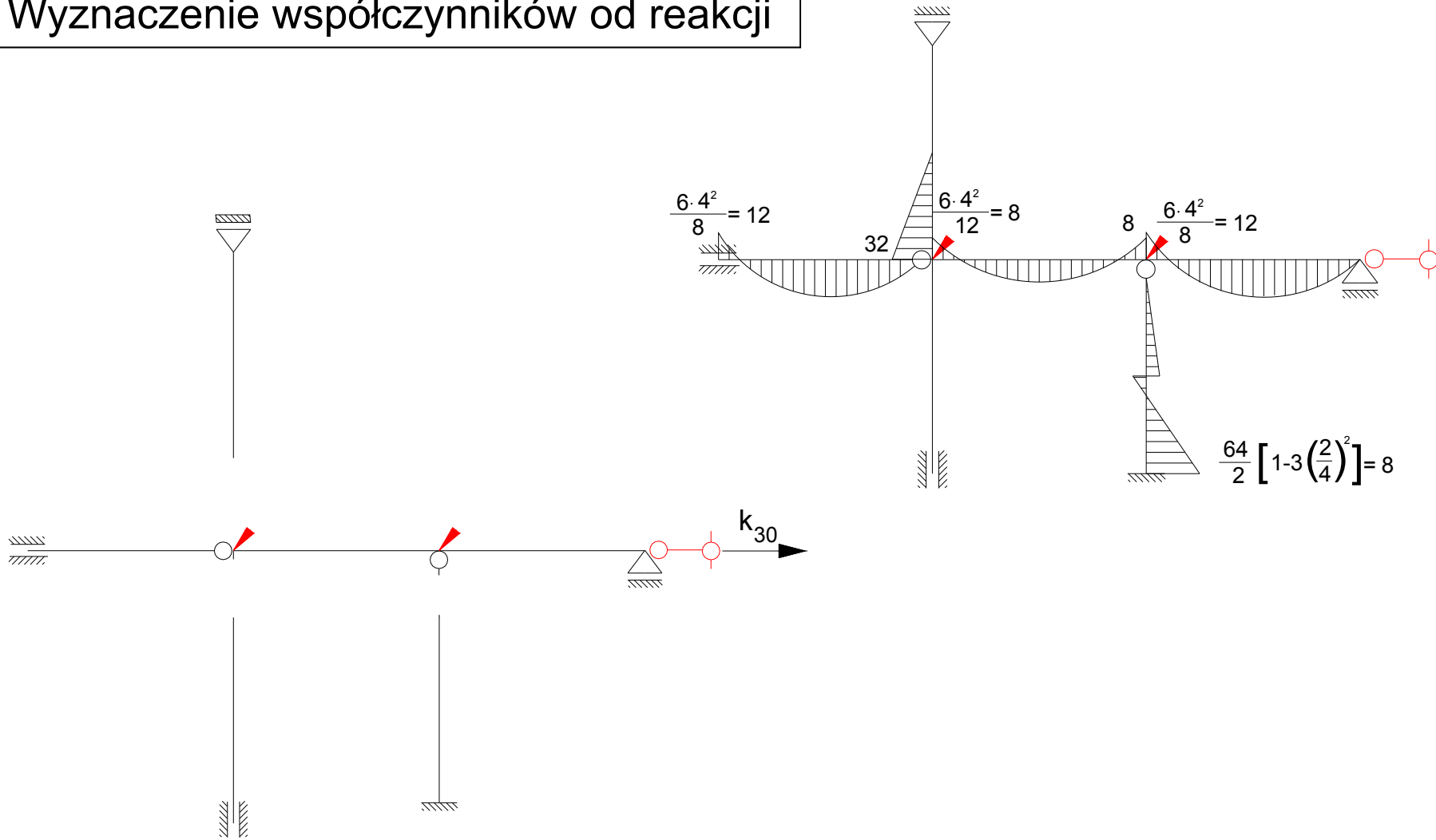

Wyznaczenie współczynników od reakcji

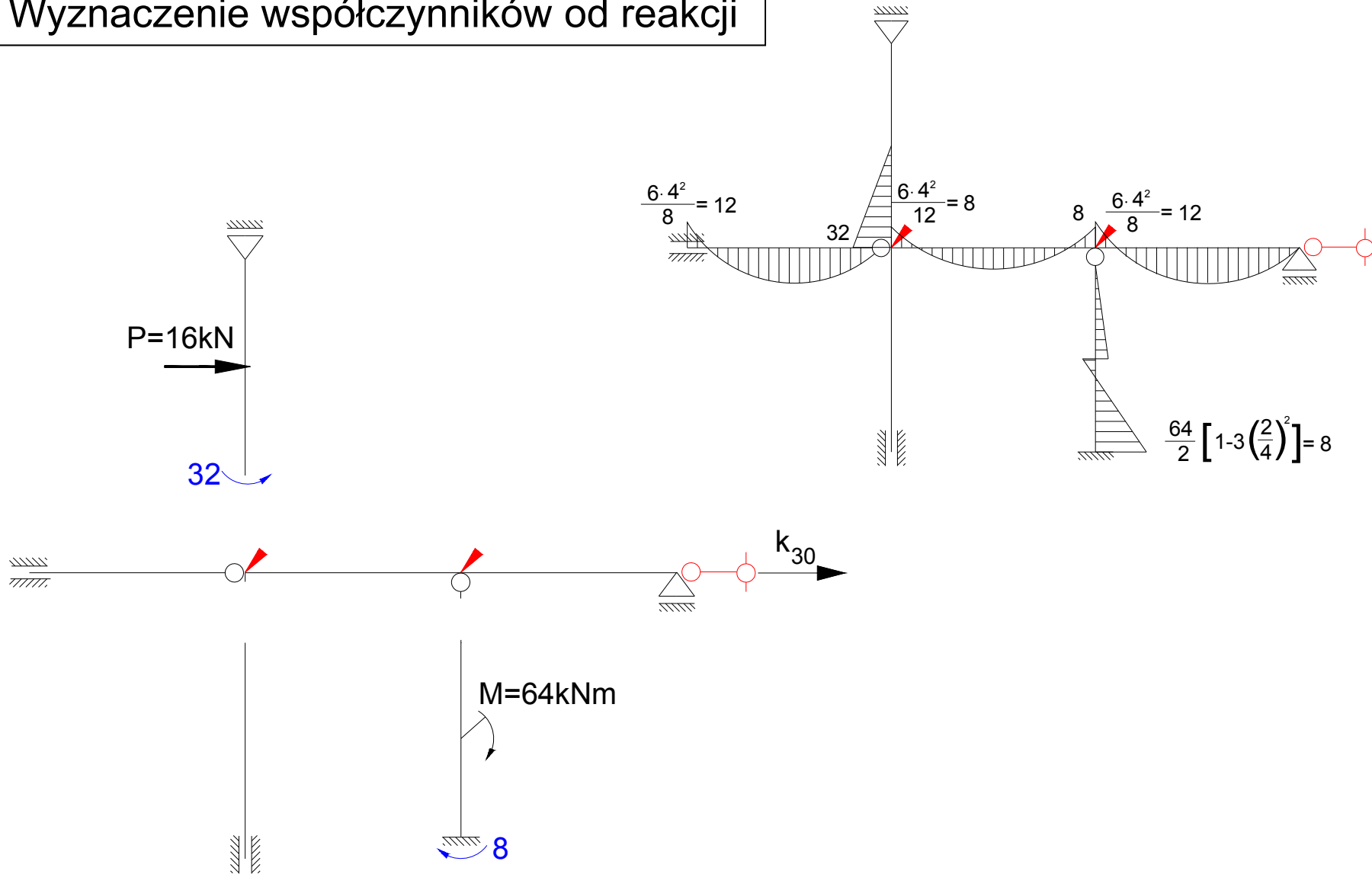

Wyznaczenie współczynników od reakcji

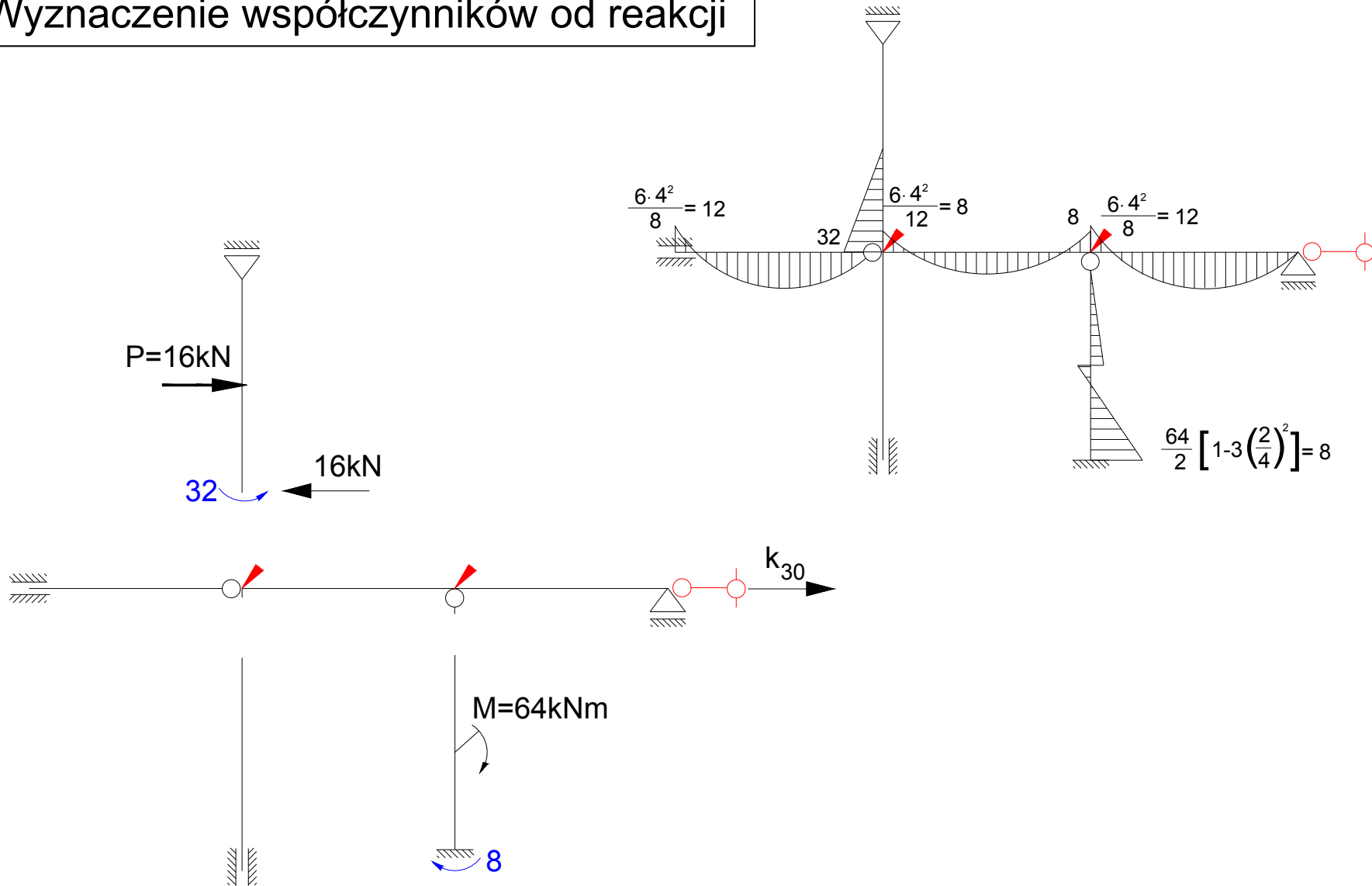

Wyznaczenie współczynników od reakcji

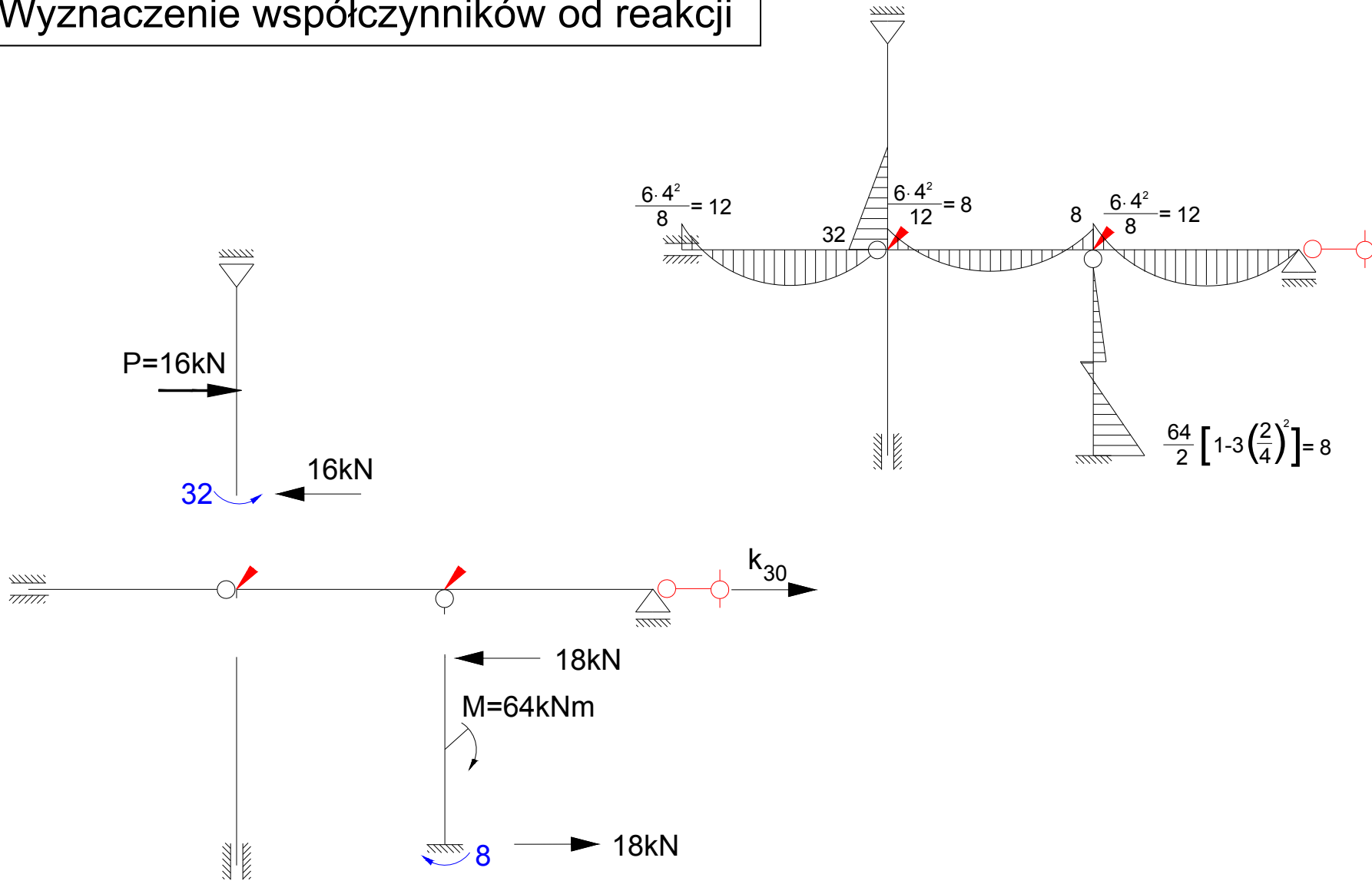

Wyznaczenie współczynników od reakcji

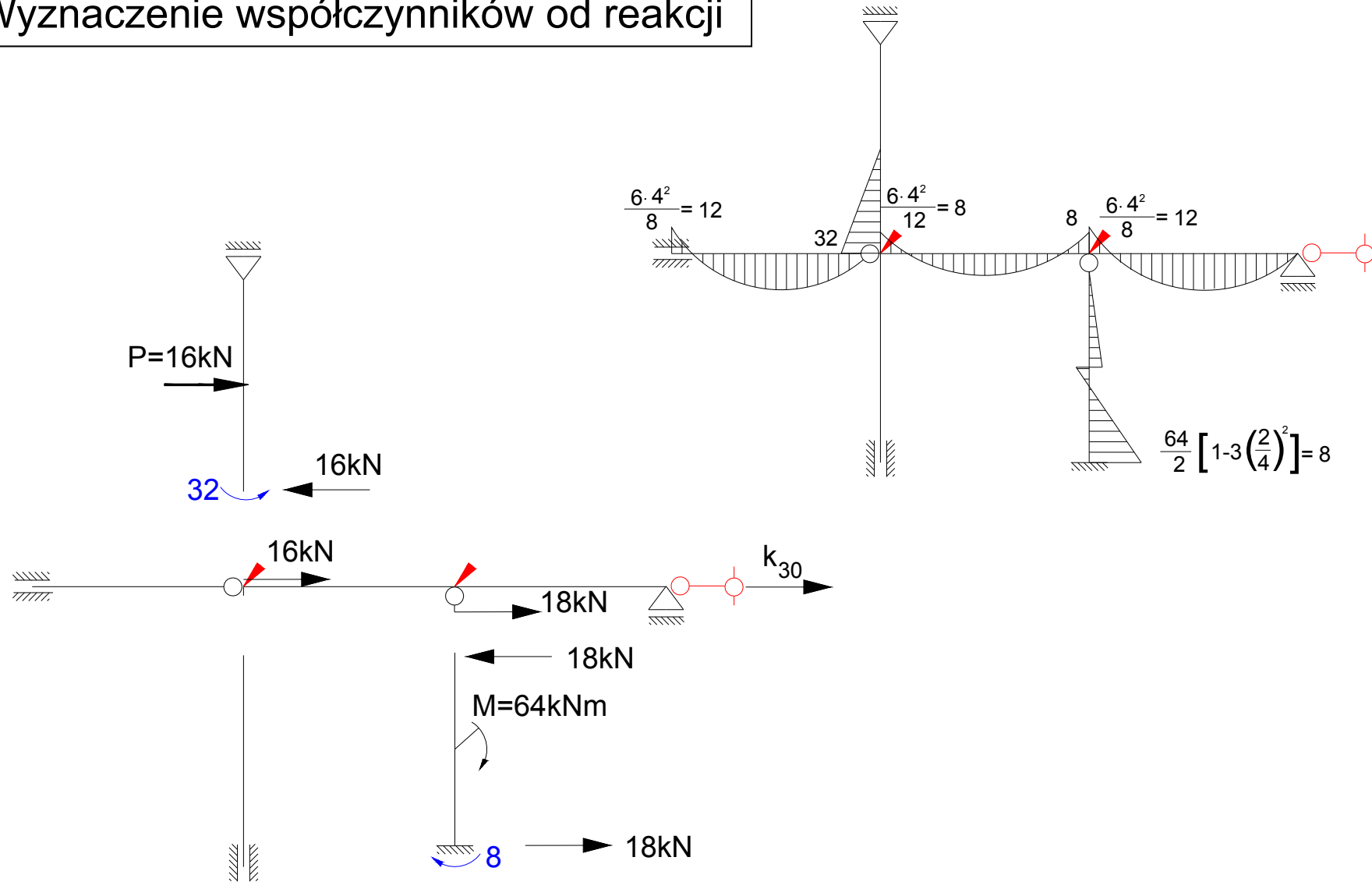

Wyznaczenie współczynników od reakcji

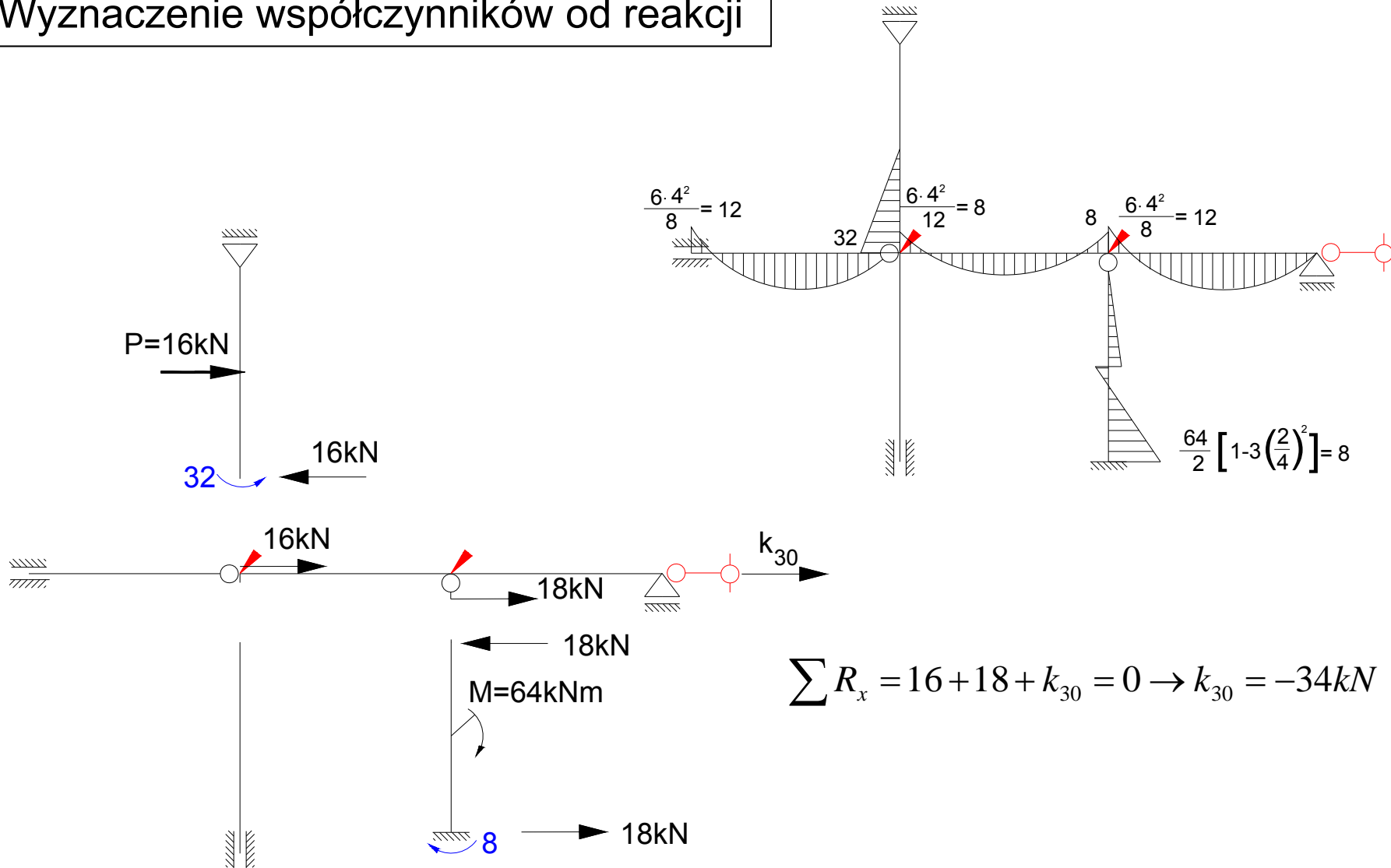

$$\sum R_x = 16 + 18 + k_{30} = 0 \rightarrow k_{30} = -34\text{kN}$$

Układ równań metody przemieszczeń:

$$k_{11} \cdot \varphi_1 + k_{12} \cdot \varphi_2 + k_{13} \cdot \Delta_3 + k_{10} = 0$$

$$k_{21} \cdot \varphi_1 + k_{22} \cdot \varphi_2 + k_{23} \cdot \Delta_3 + k_{20} = 0$$

$$k_{31} \cdot \varphi_1 + k_{32} \cdot \varphi_2 + k_{33} \cdot \Delta_3 + k_{30} = 0$$

Podstawiając wyliczone wcześniej wartości otrzymujemy:

$$3EJ \cdot \varphi_1 + EJ \cdot \varphi_2 - \frac{3EJ}{8} \cdot \Delta_3 - 40 = 0$$

$$EJ \cdot \varphi_1 + \frac{7EJ}{2} \cdot \varphi_2 + 0 \cdot \Delta_3 - 4 = 0$$

$$-\frac{3EJ}{8} \cdot \varphi_1 + 0 \cdot \varphi_2 + \frac{15EJ}{64} \cdot \Delta_3 - 34 = 0$$

Rozwiązanie układu równań:

$$\varphi_1 = \frac{44,11}{EJ}$$

$$\varphi_2 = \frac{-11,46}{EJ}$$

$$\Delta_3 = \frac{215,64}{EJ}$$

Wyznaczenie momentów na końcach elementów:

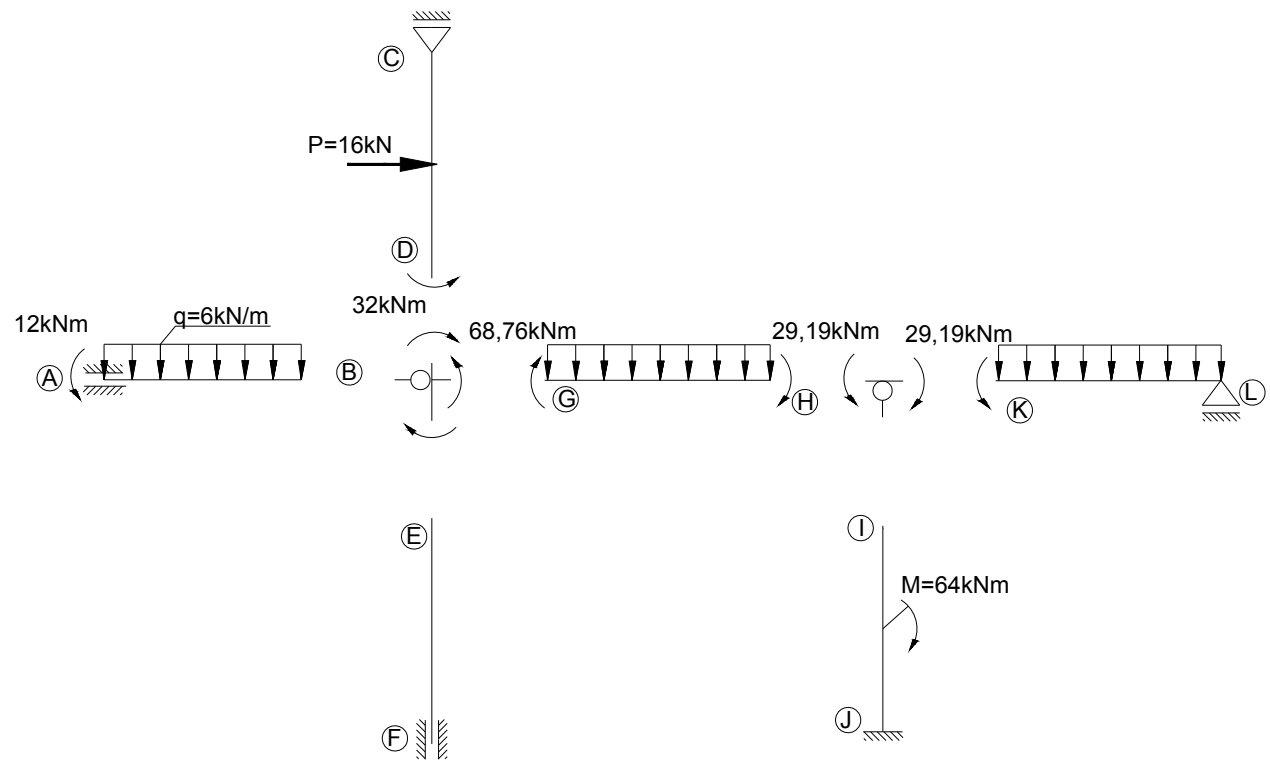

$$M_K = 0 \cdot \frac{44,11}{EJ} + \frac{3}{2} EJ \cdot \frac{-11,46}{EJ} + 0 \cdot \frac{215,64}{EJ} - 12 = -29,19 \text{ kNm}$$

Wyznaczenie momentów na końcach elementów:

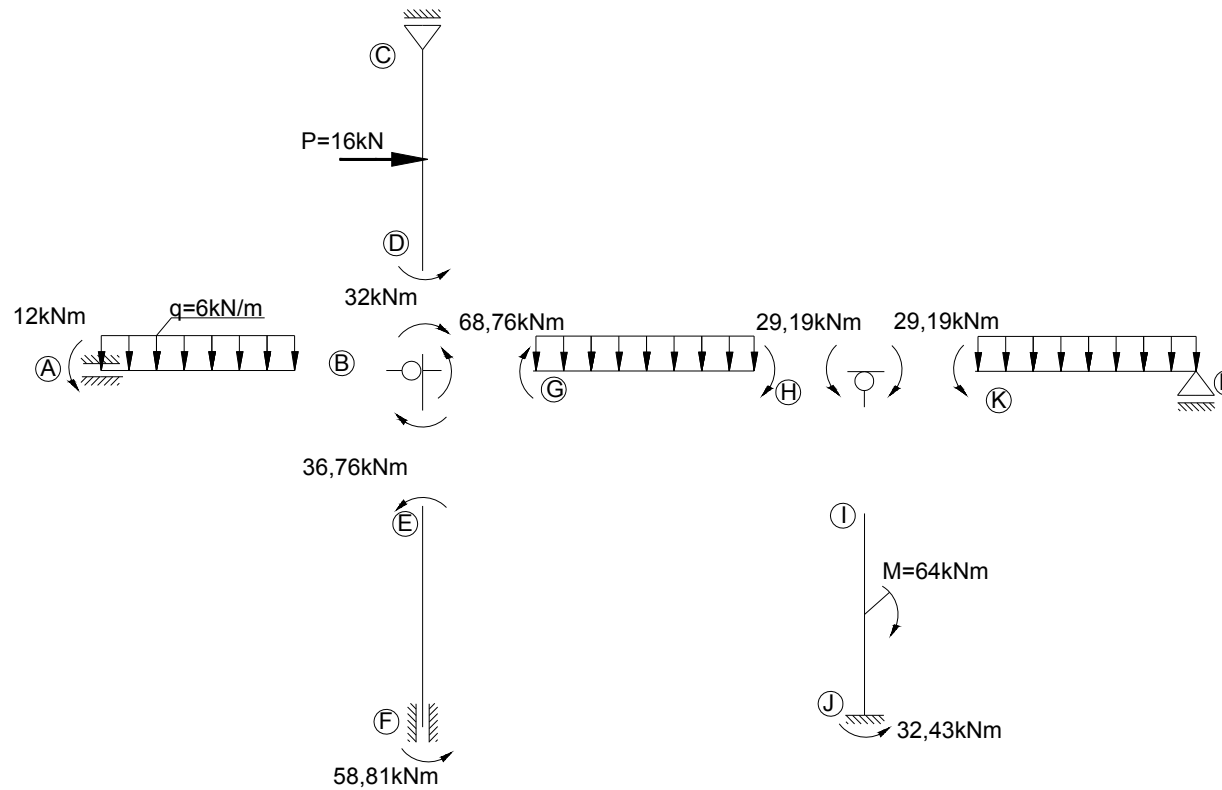

$$M_i = M^{\varphi_1=1} \cdot \varphi_1 + M^{\varphi_2=1} \cdot \varphi_2 + M^{\Delta_3=1} \cdot \Delta_3 + M^{obc.zewn.}$$

Wyznaczenie sił tnących i normalnych:

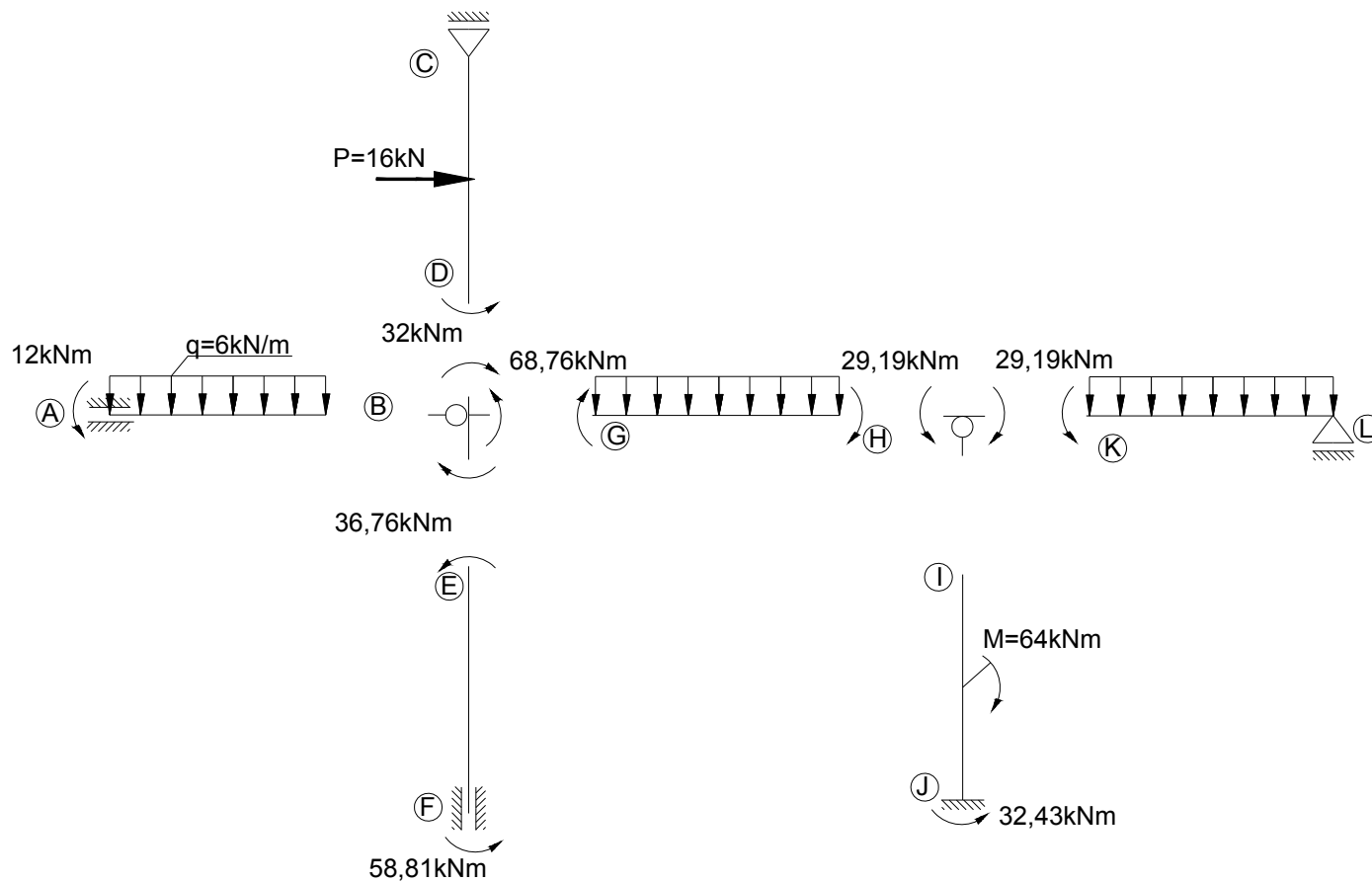

Wyznaczenie sił tnących i normalnych:

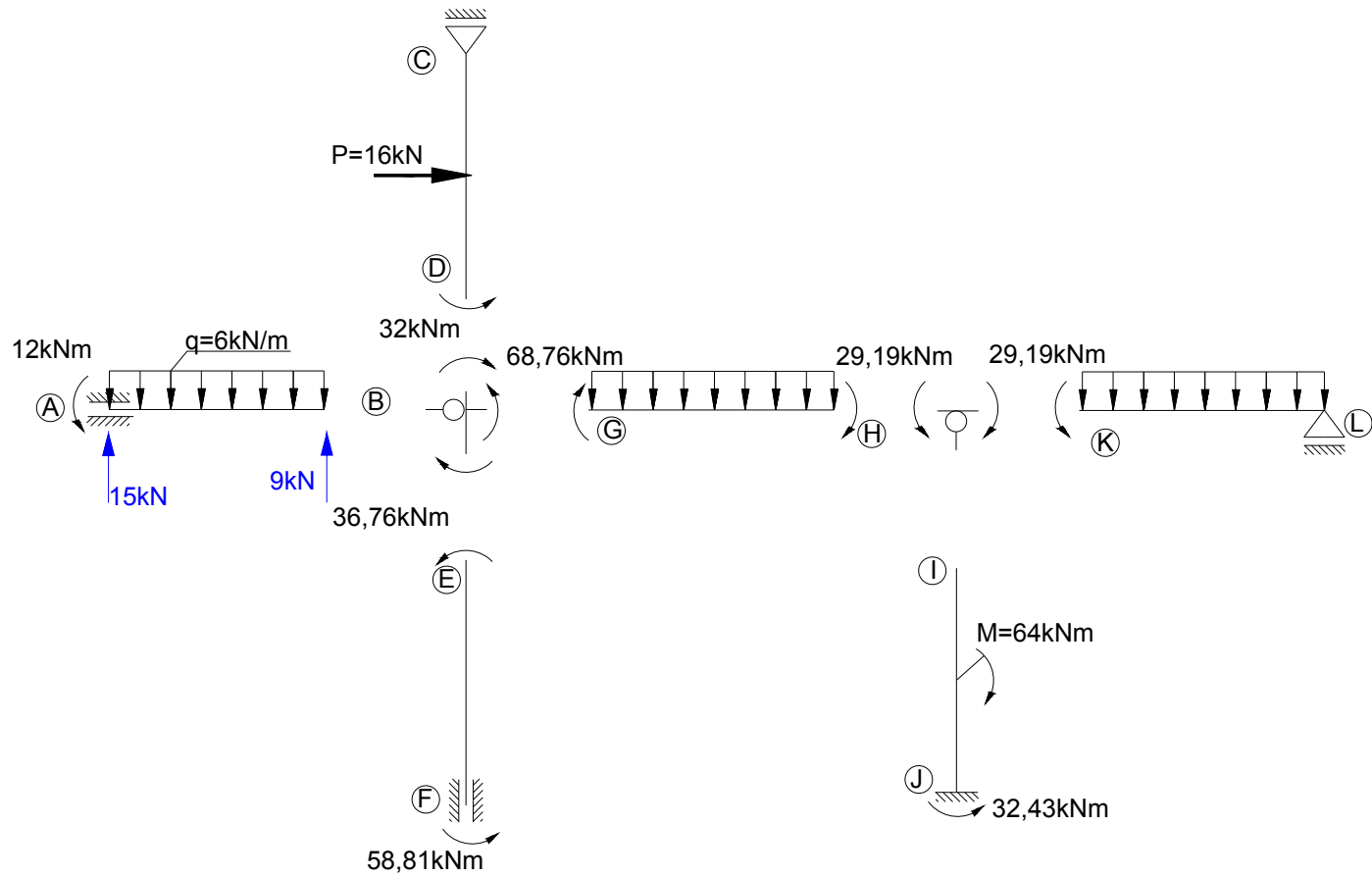

Wyznaczenie sił tnących i normalnych:

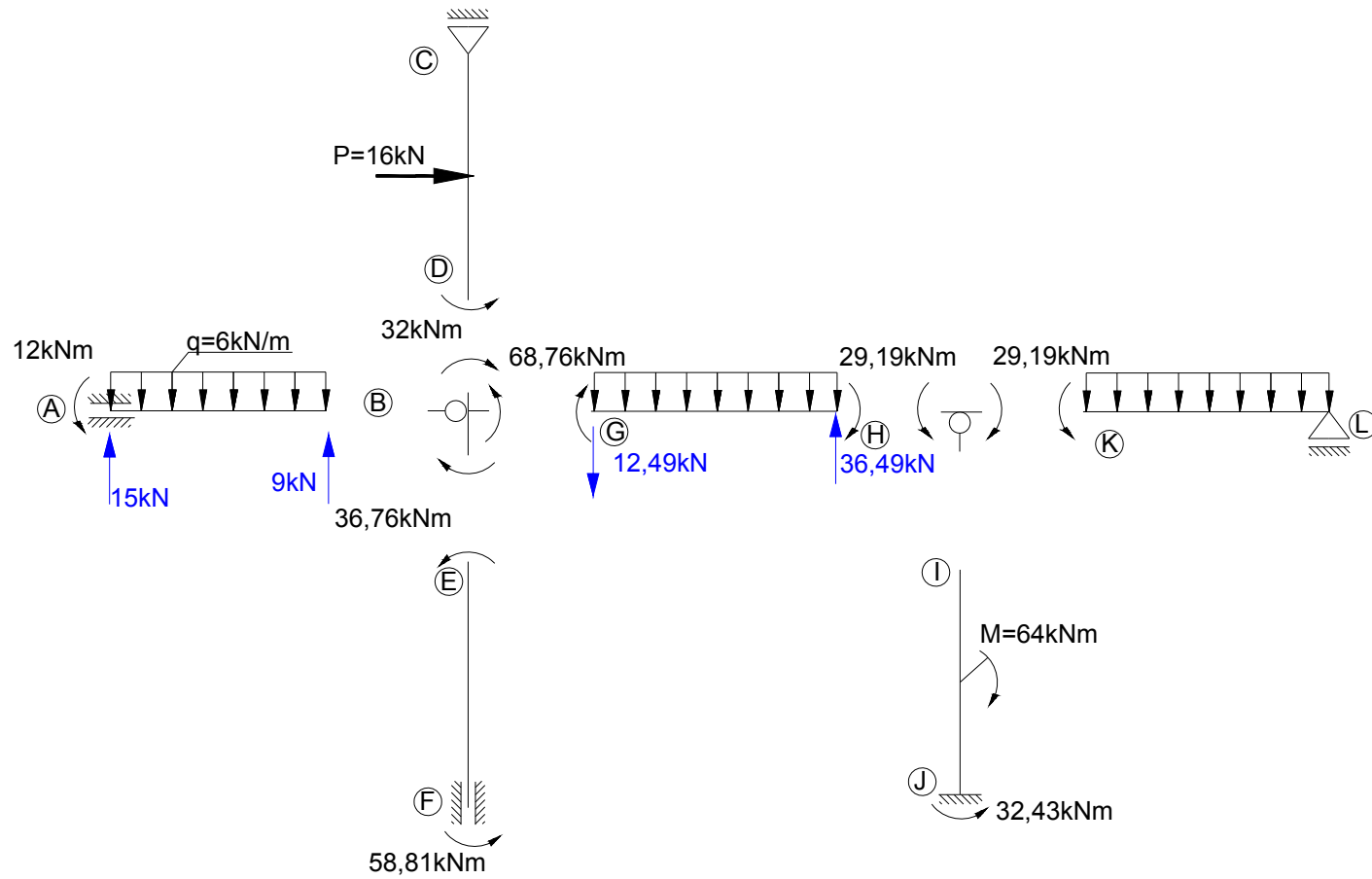

Wyznaczenie sił tnących i normalnych:

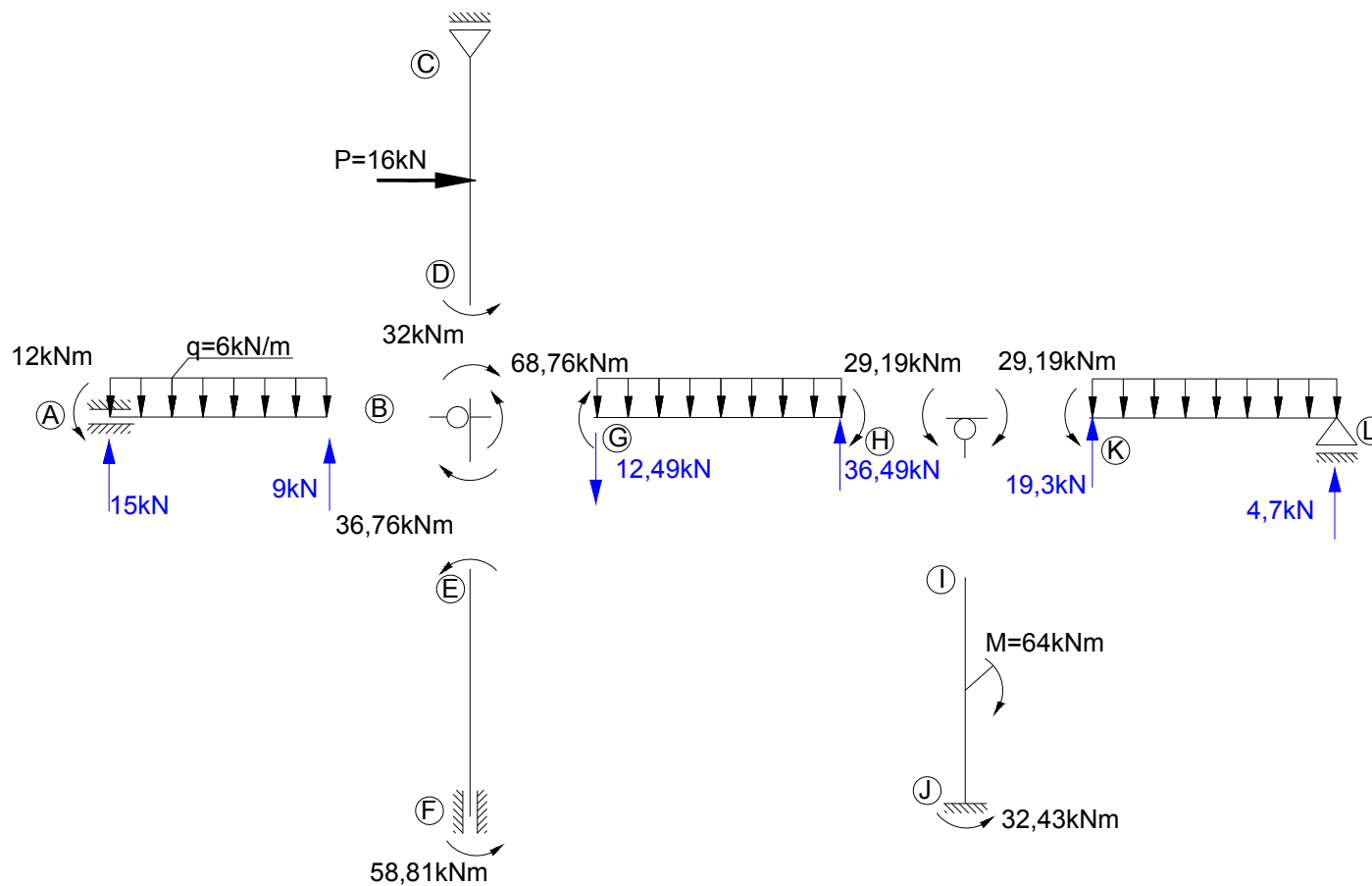

Wyznaczenie sił tnących i normalnych:

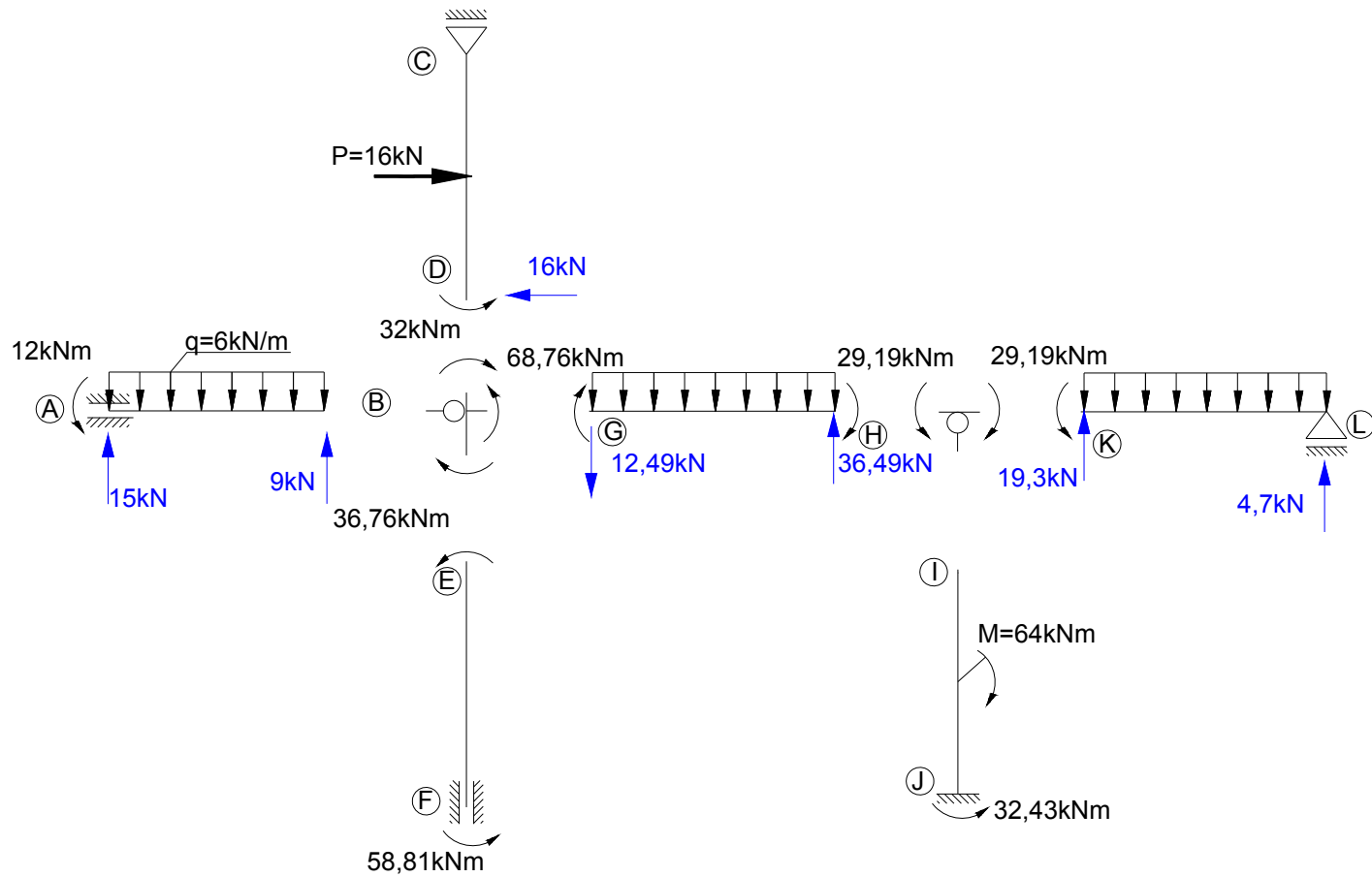

Wyznaczenie sił tnących i normalnych:

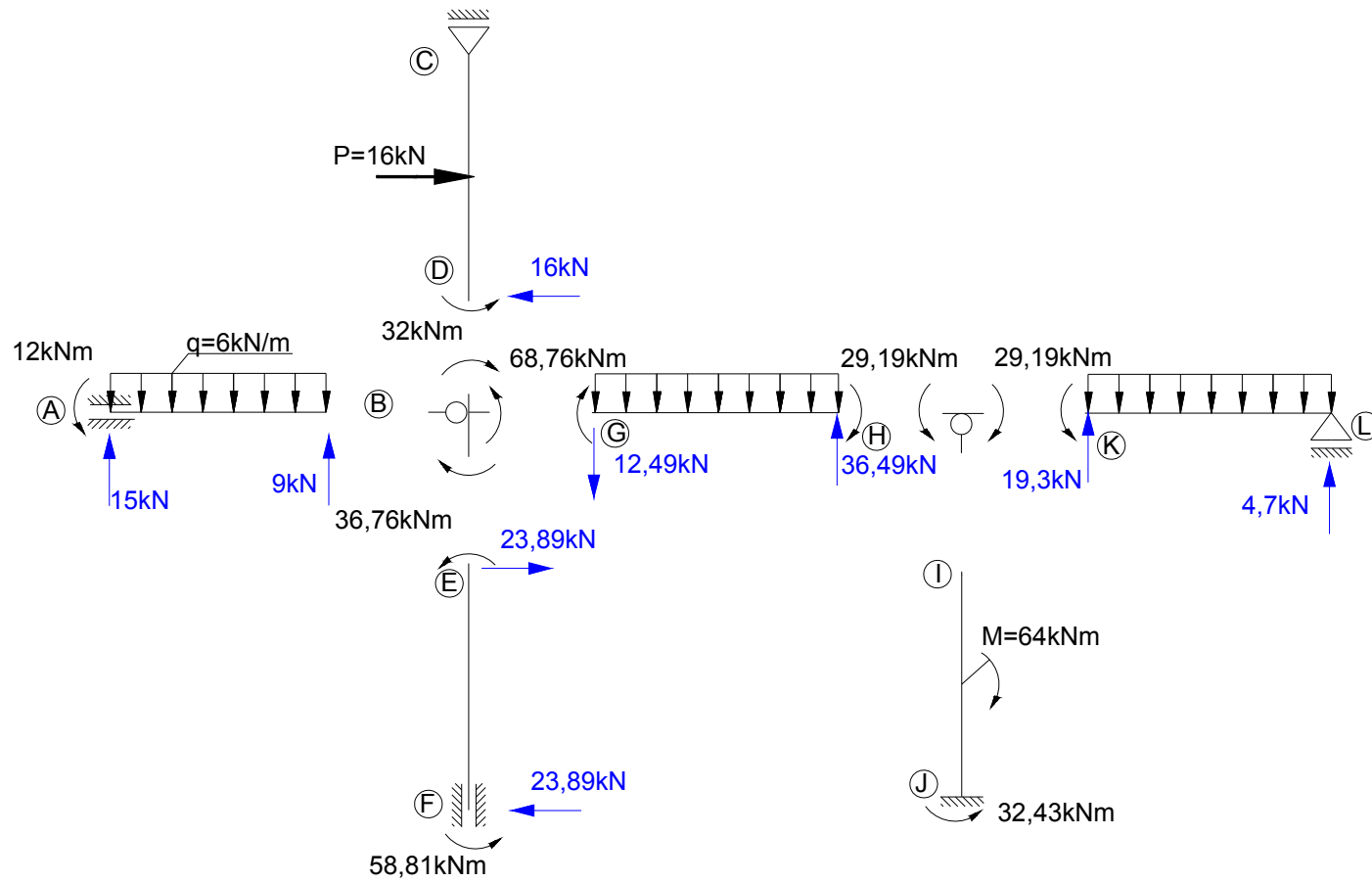

Wyznaczenie sił tnących i normalnych:

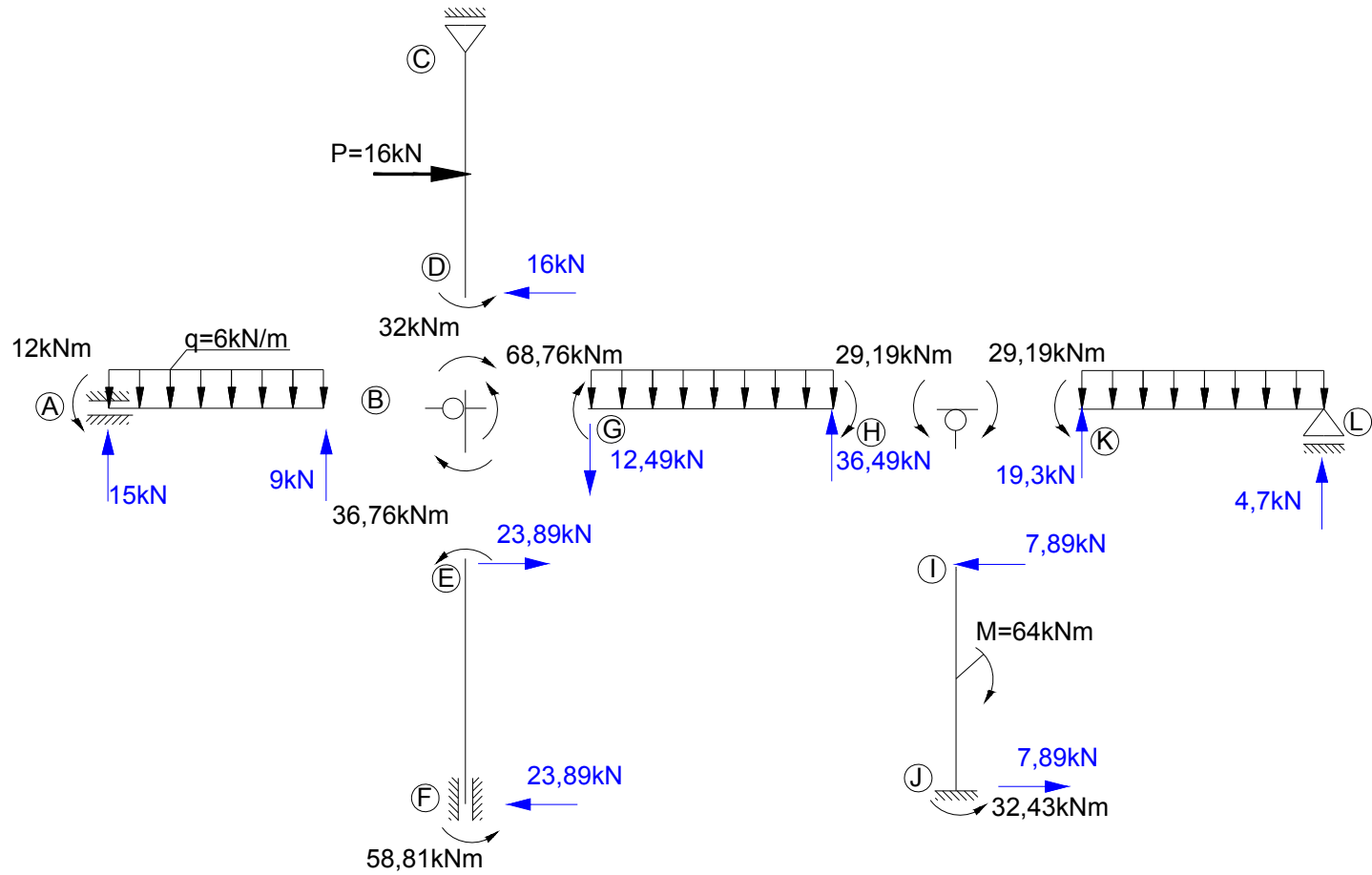

Wyznaczenie sił tnących i normalnych:

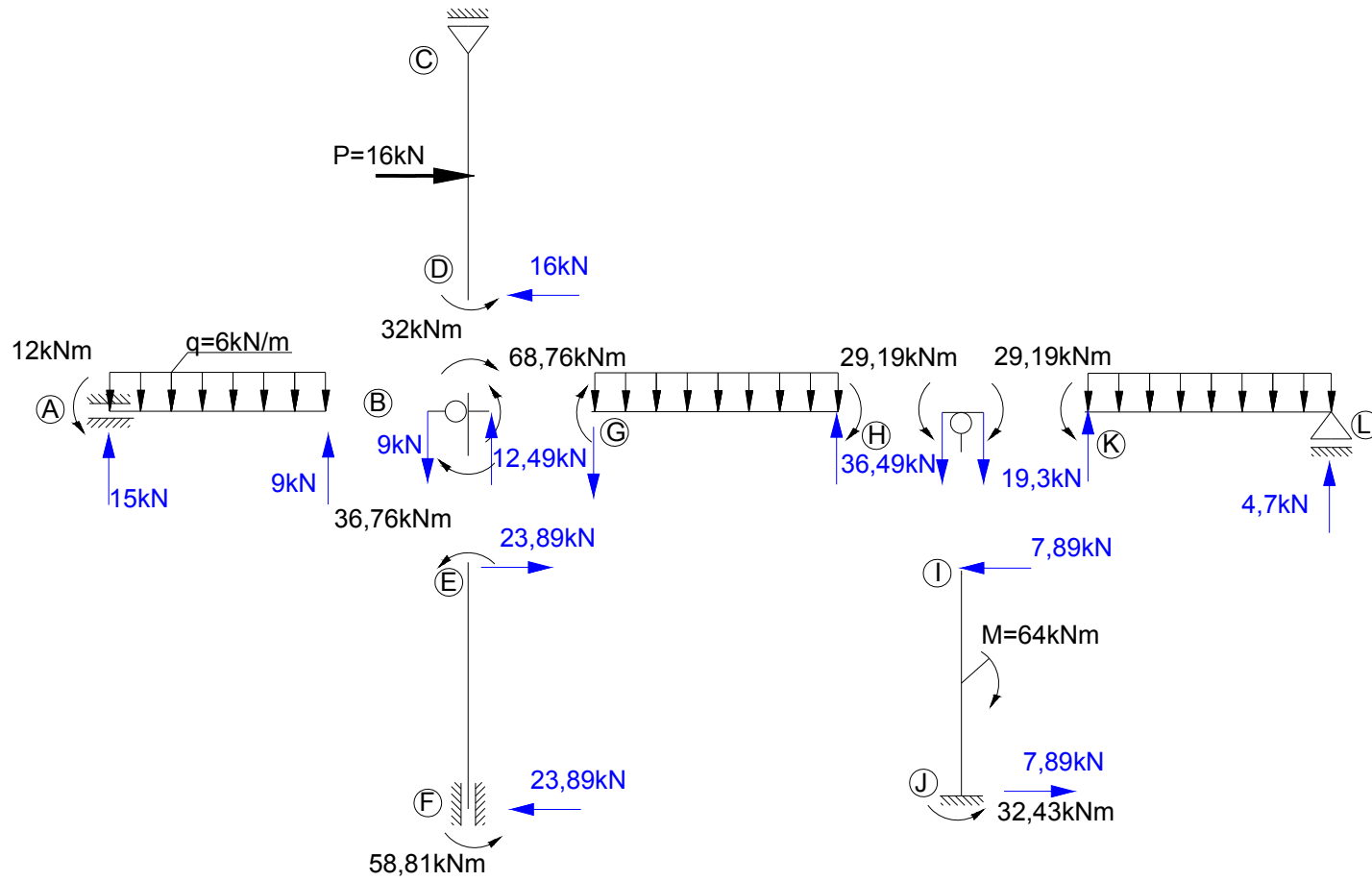

Wyznaczenie sił tnących i normalnych:

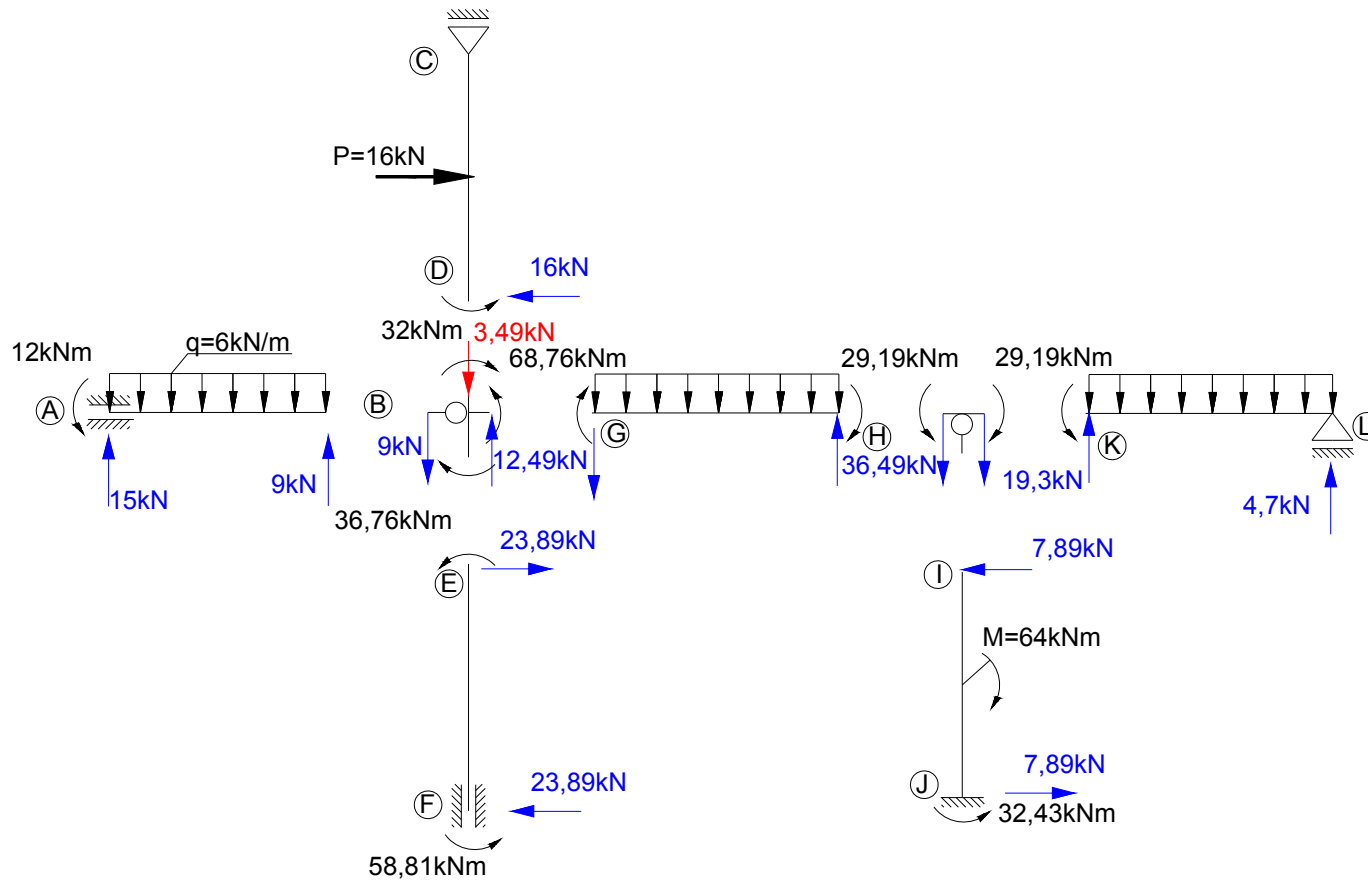

Wyznaczenie sił tnących i normalnych:

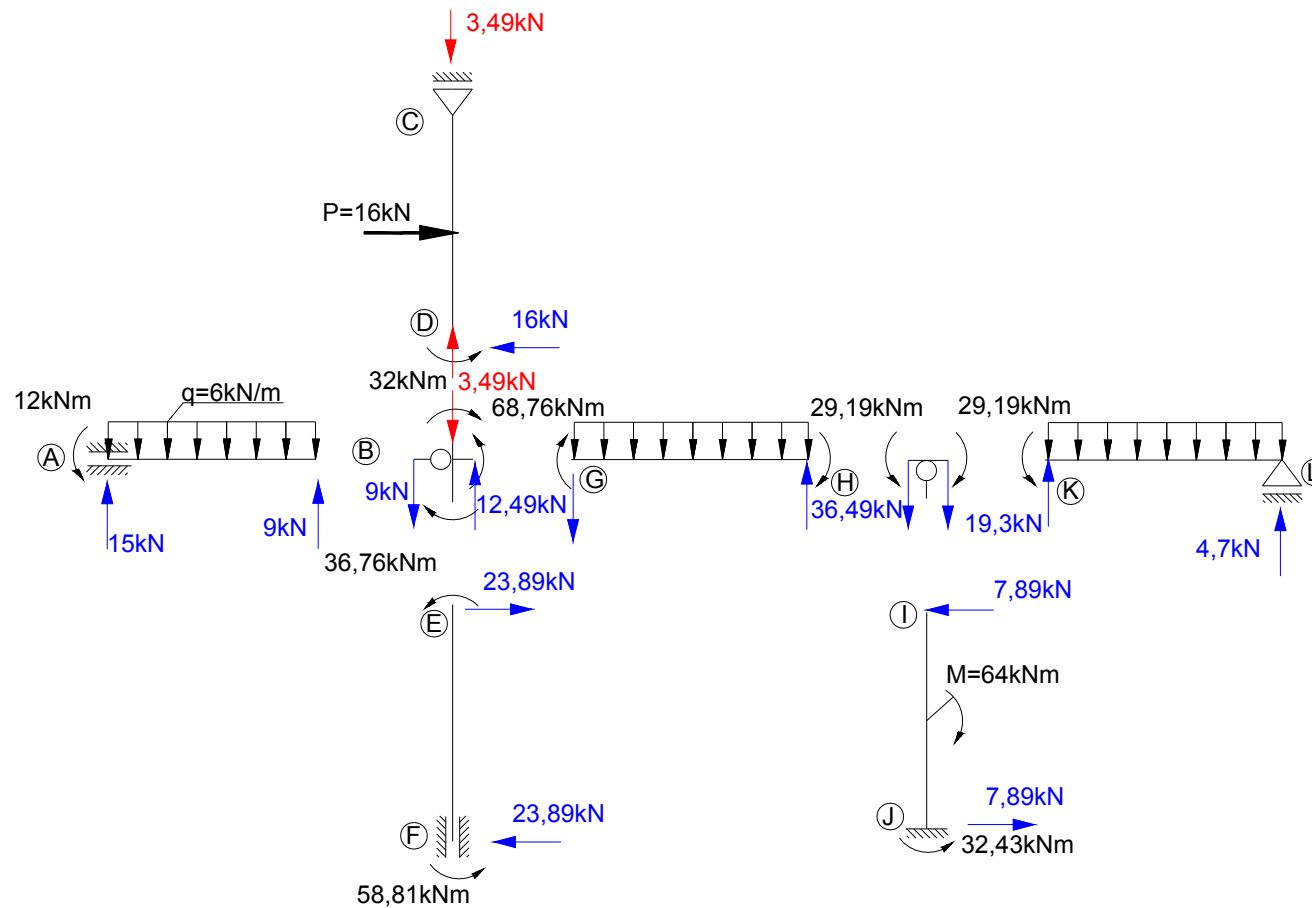

Wyznaczenie sił tnących i normalnych:

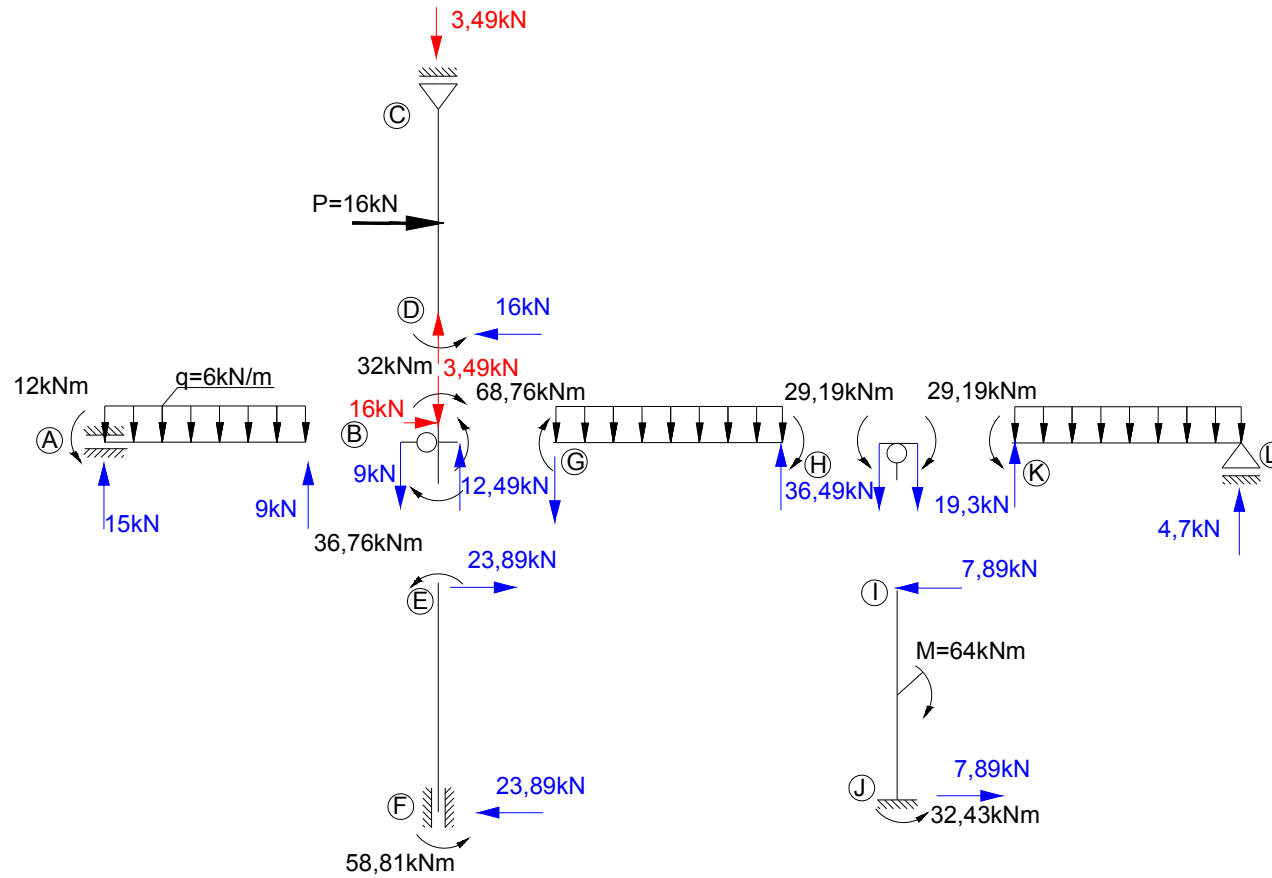

Wyznaczenie sił tnących i normalnych:

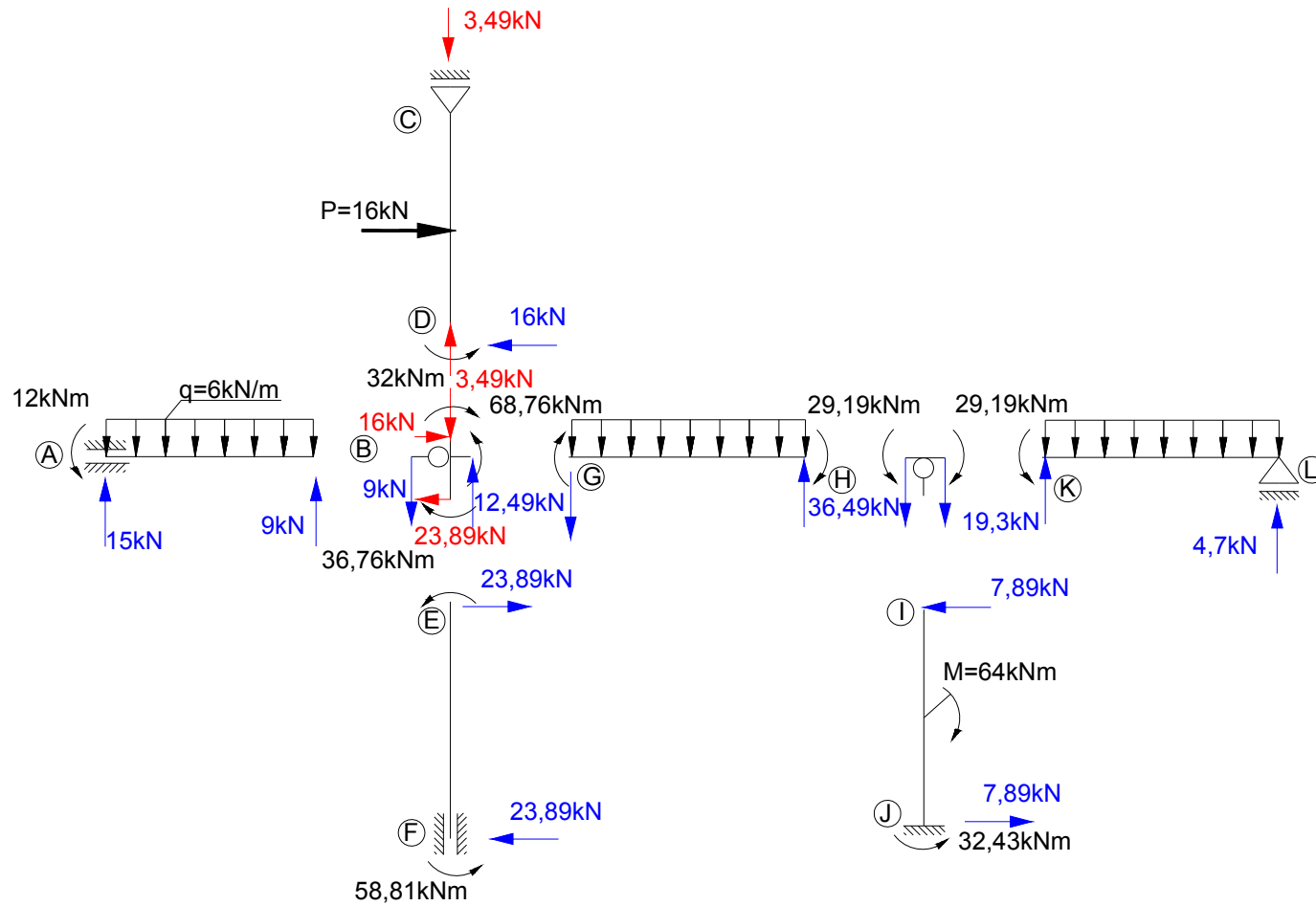

Wyznaczenie sił tnących i normalnych:

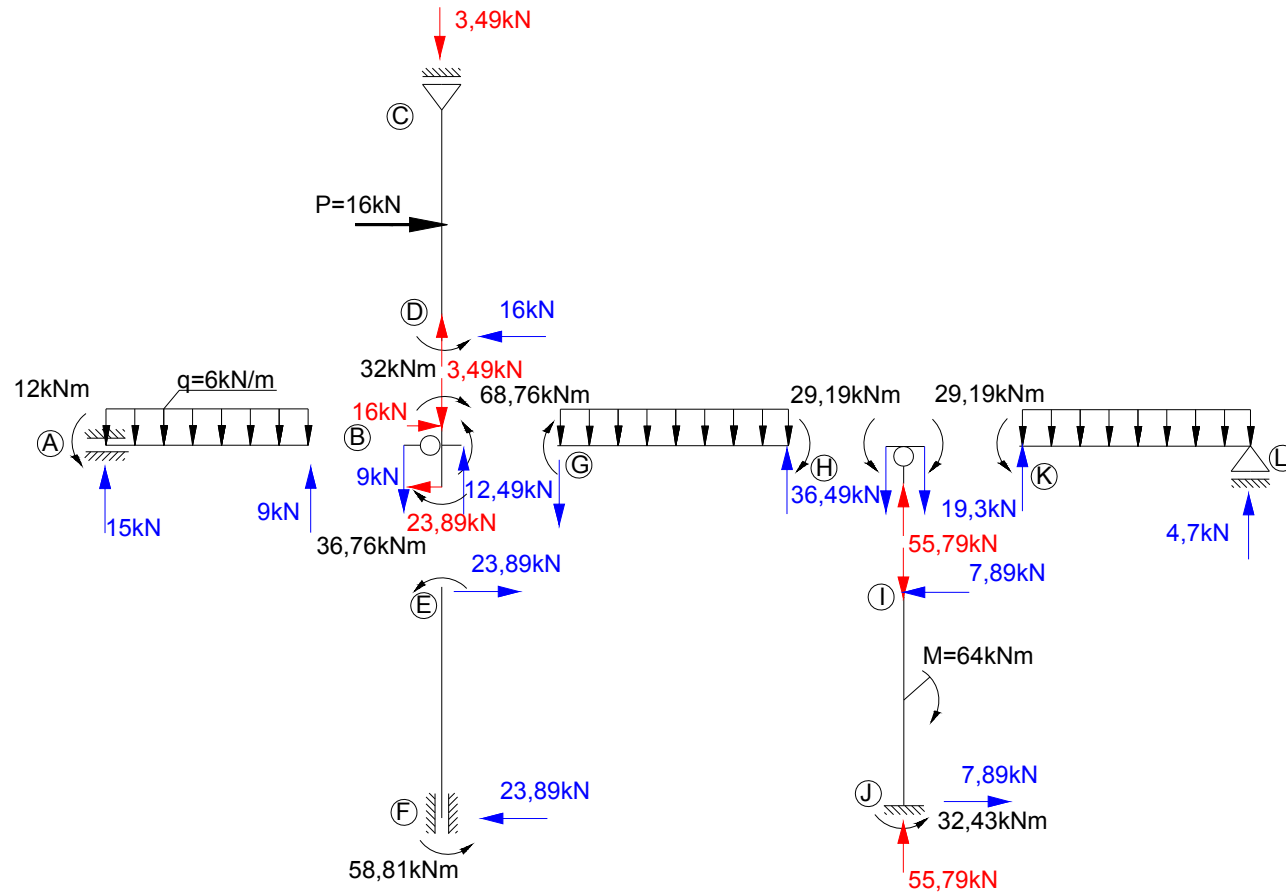

Wyznaczenie sił tnących i normalnych:

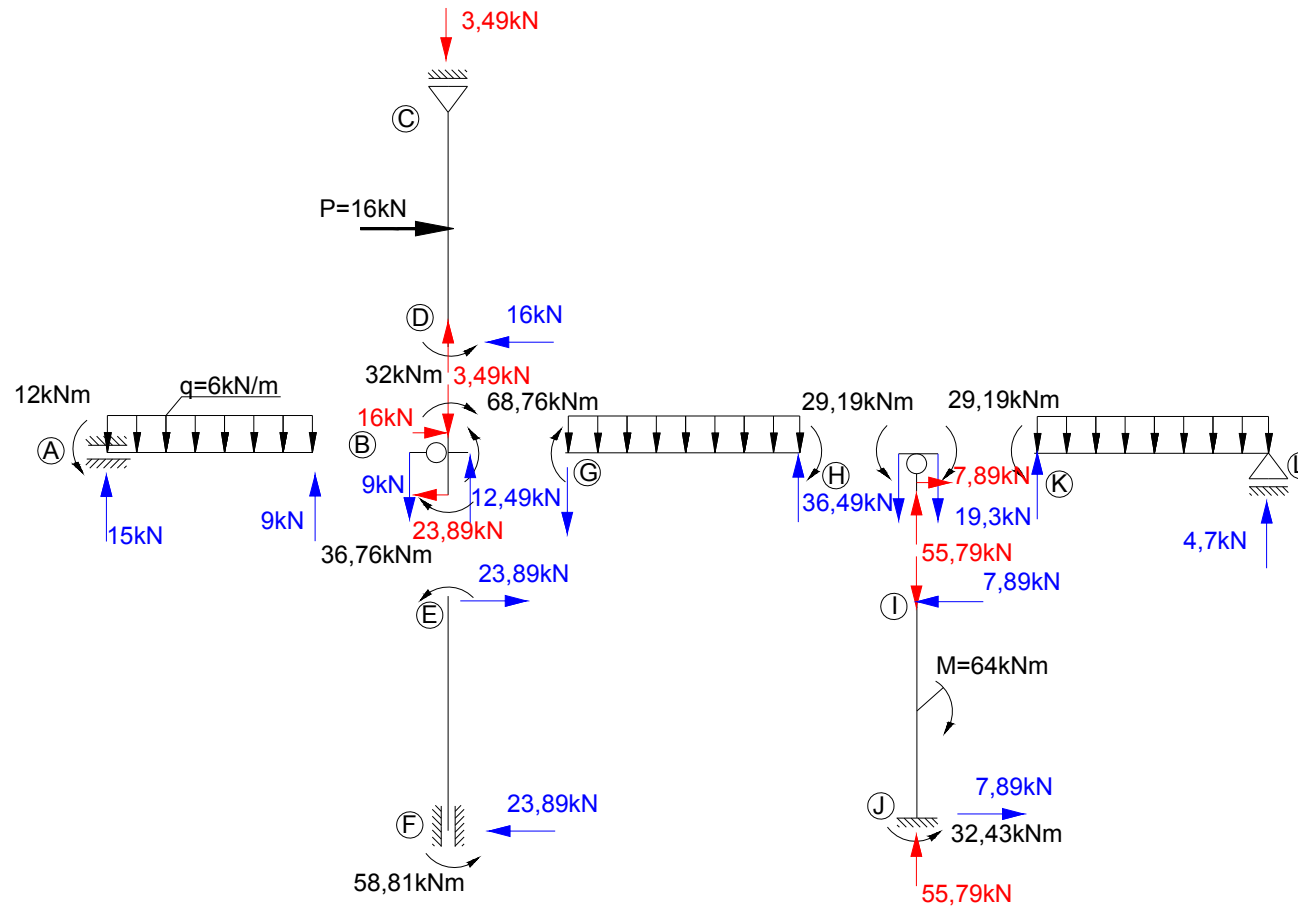

Wyznaczenie sił tnących i normalnych:

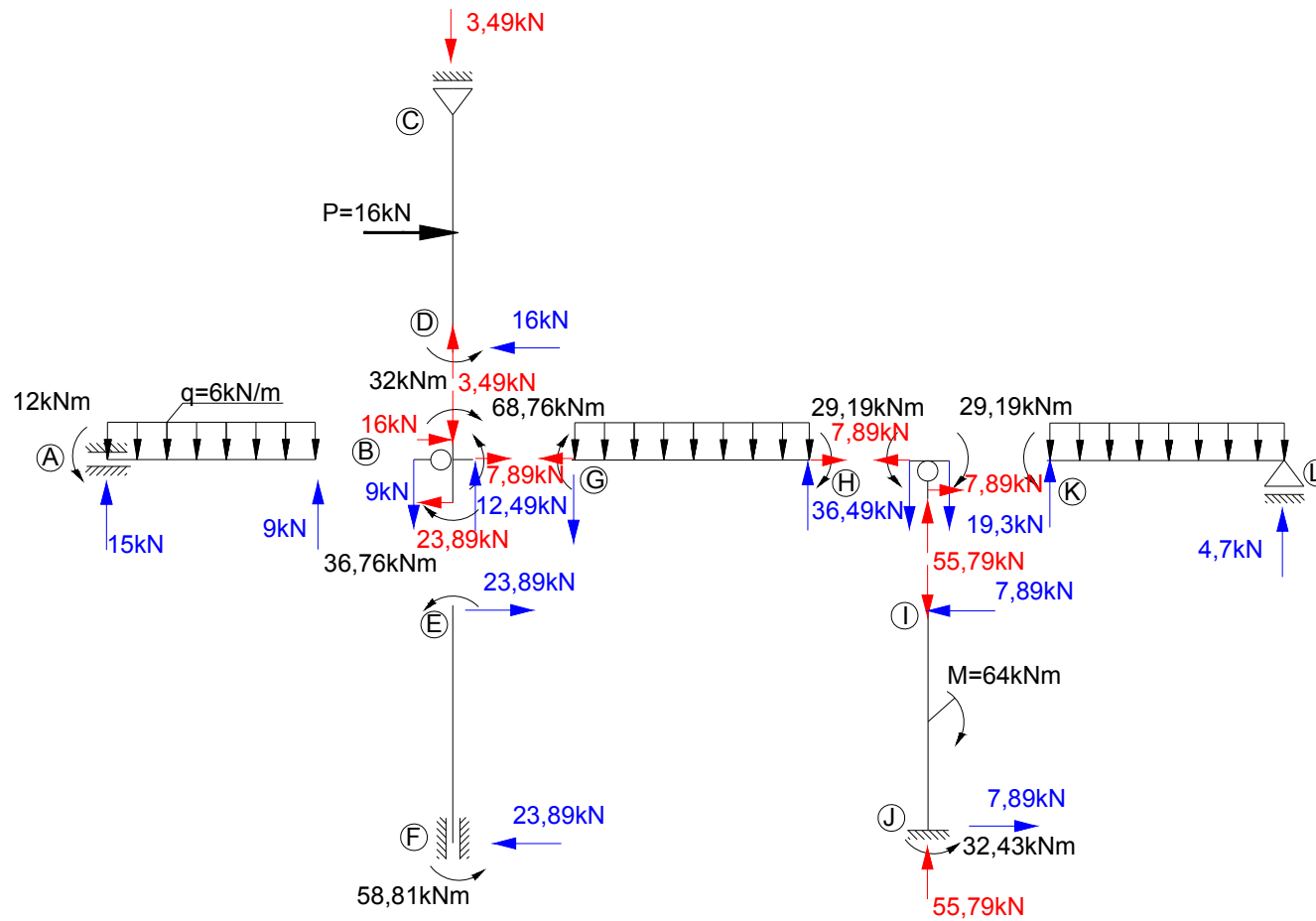

Wykres sił tnących:

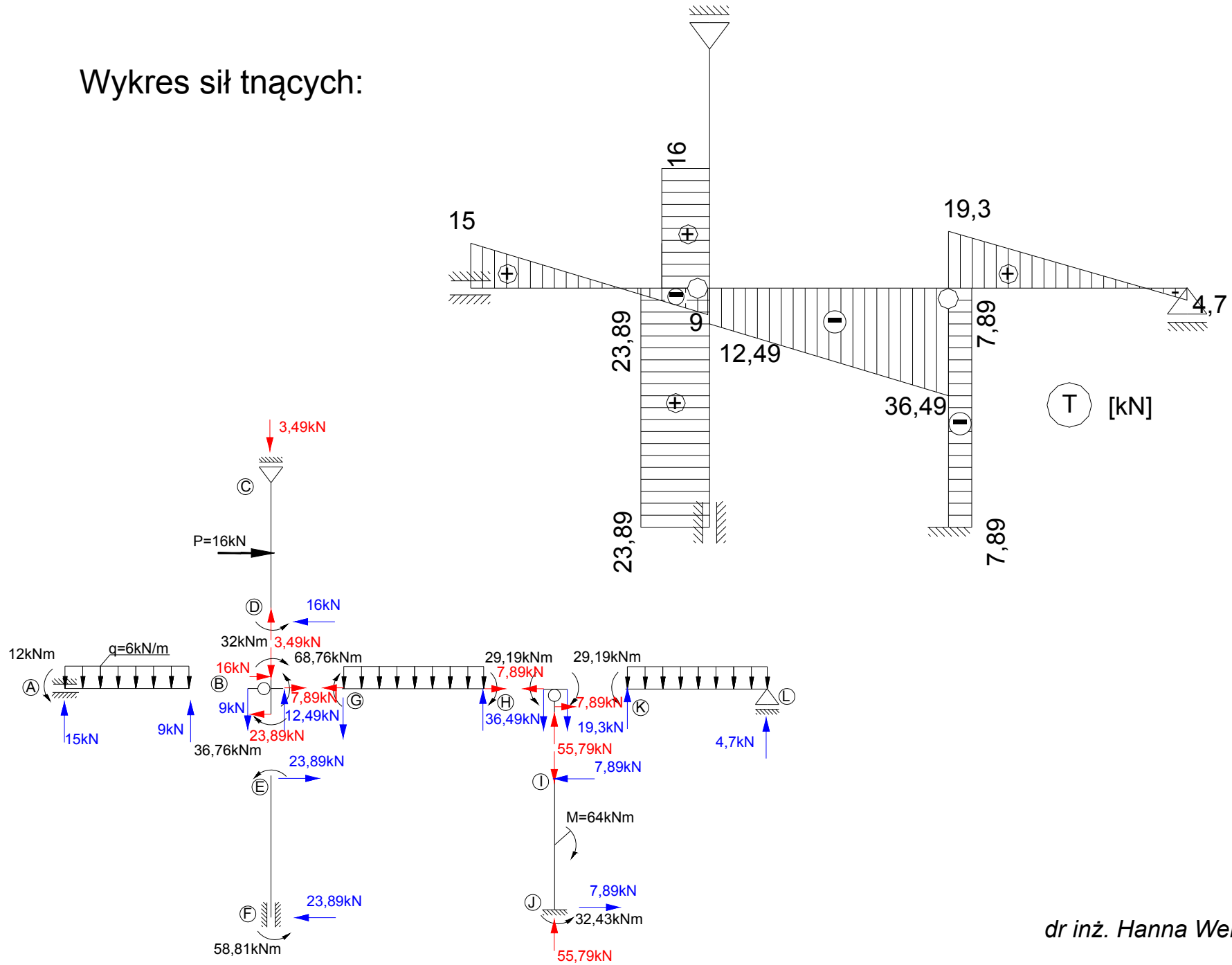

dr inż. Hanna Weber

Wyznaczenie ekstremów:

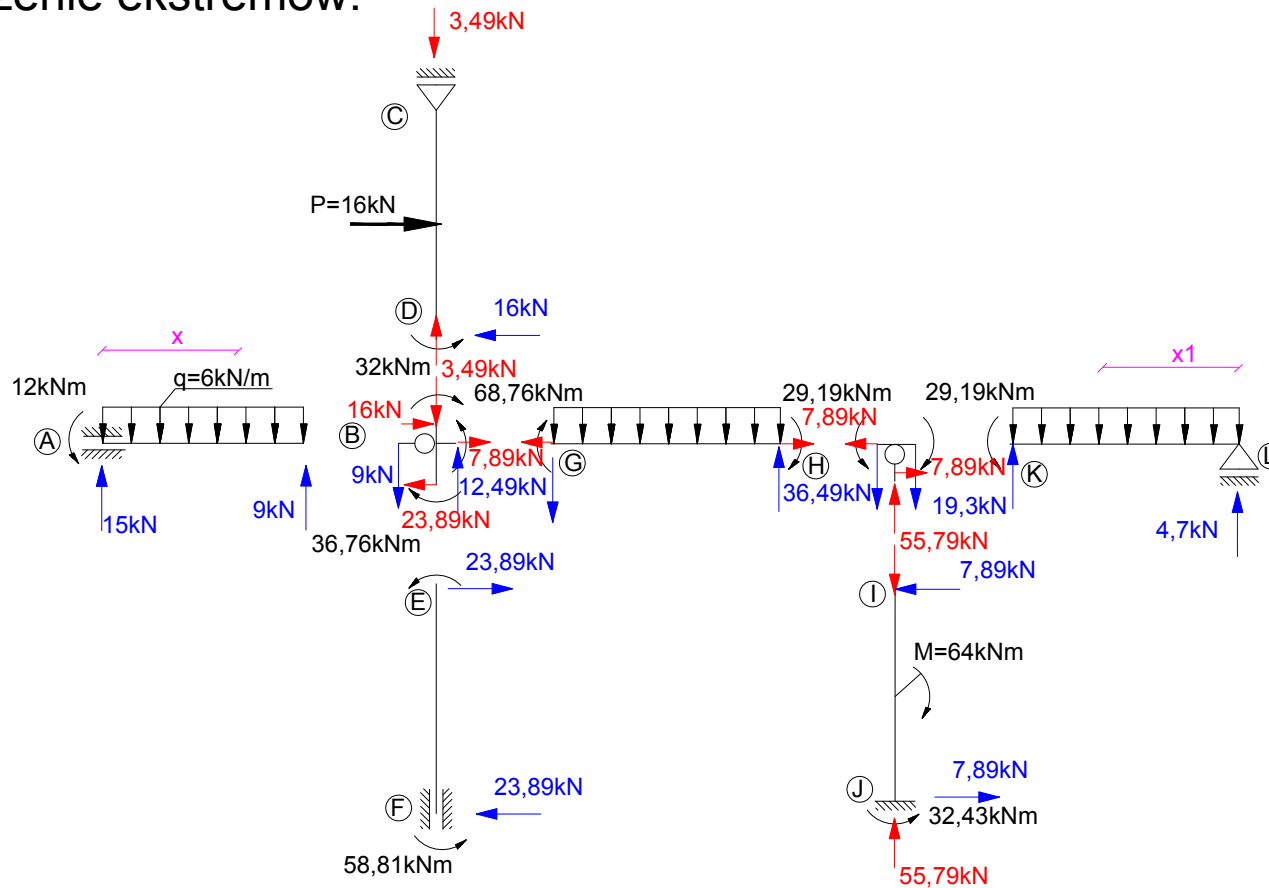

$$T(x) = 15 - 6x = 0 \rightarrow x = \frac{15}{6} = 2,5m$$

$$M(x = 2,5m) = -12 + 15 \cdot 2,5 - 6 \cdot \frac{2,5^2}{2} = 6,75kNm$$

Wyznaczenie ekstremów:

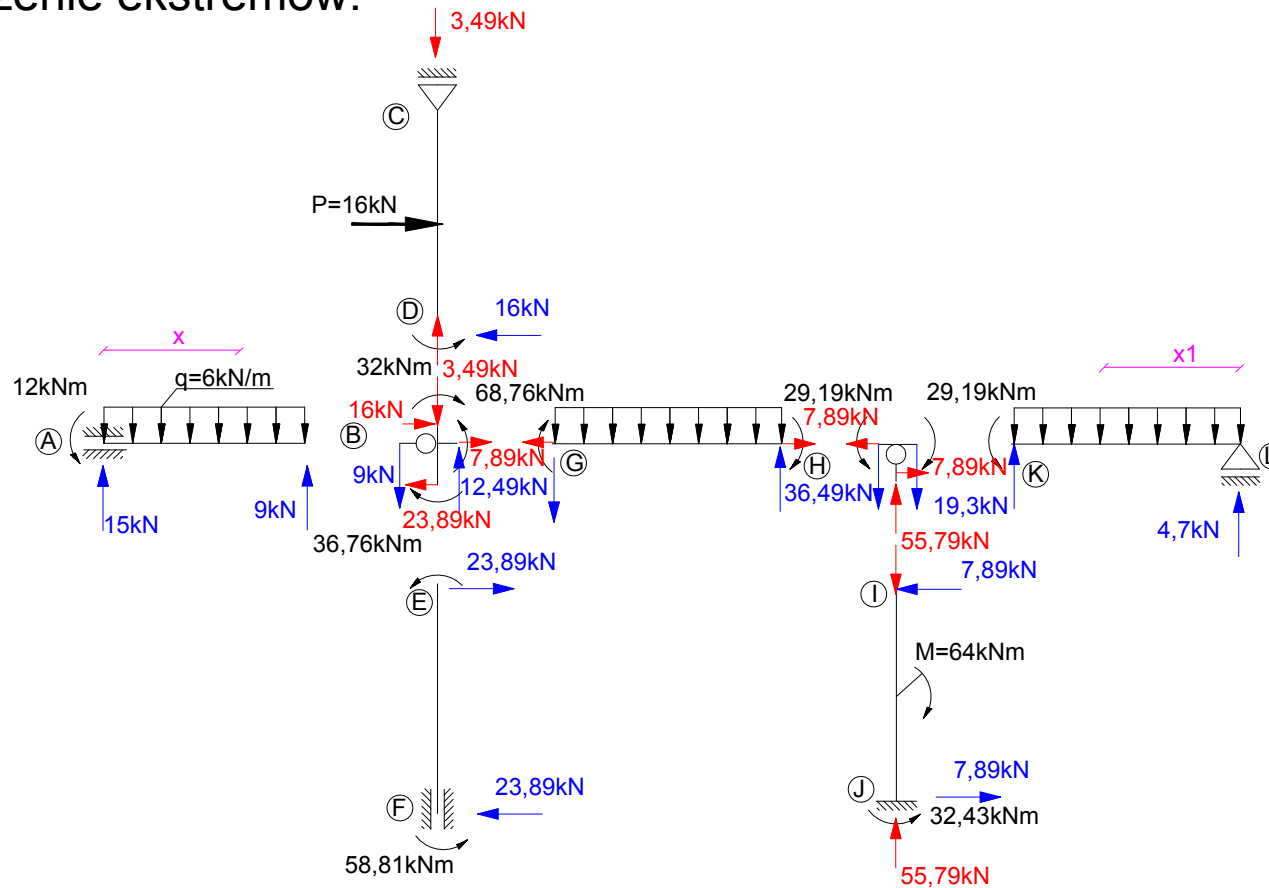

$$T(x1) = -4,7 + 6x = 0 \rightarrow x = \frac{4,7}{6} = 0,783m$$

$$M(x1 = 0,783m) = 4,7 \cdot 0,783 - 6 \cdot \frac{0,783^2}{2} = 1,84kNm$$

Wykres sił normalnych:

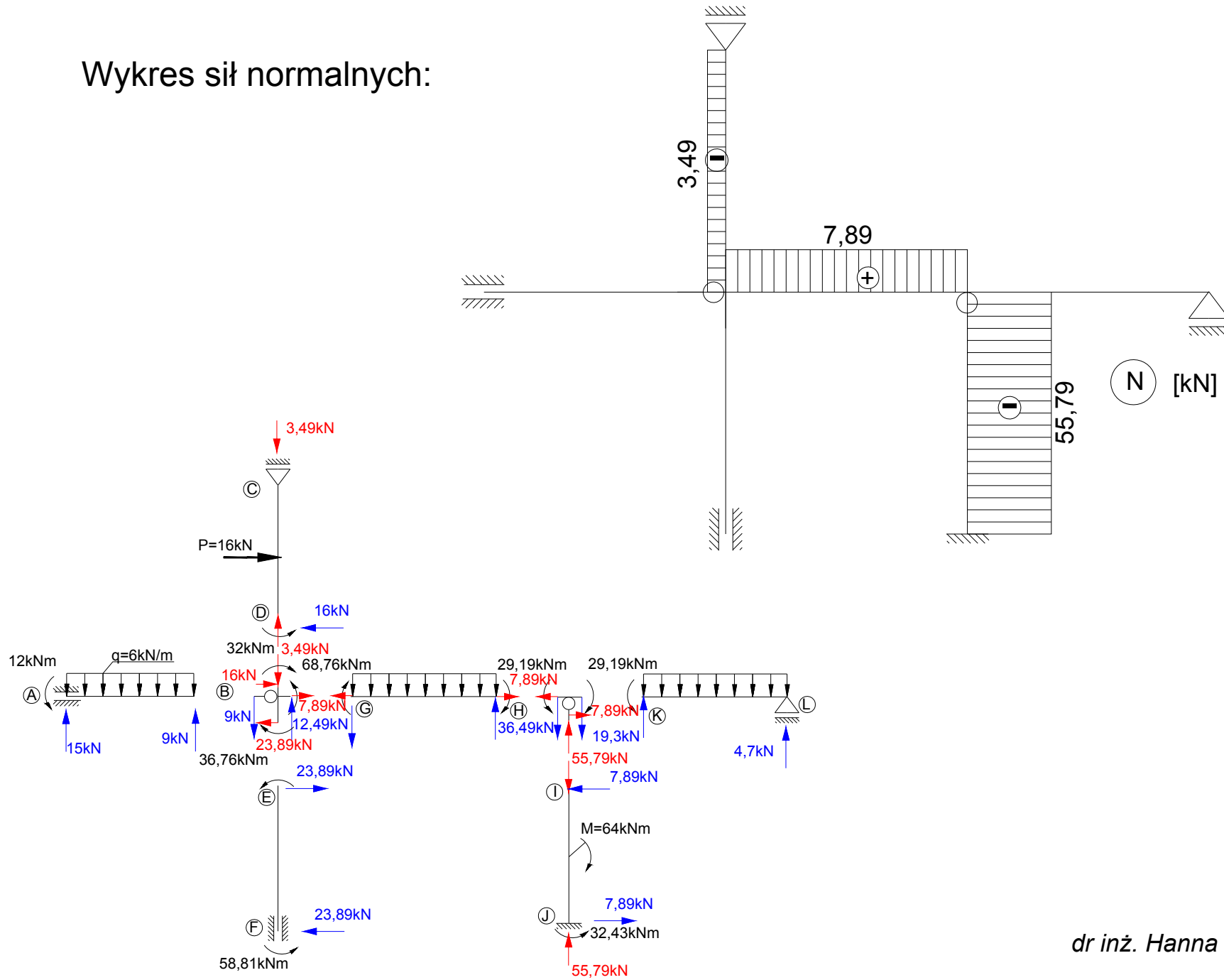

dr inż. Hanna Weber

Wykres momentów zginających:

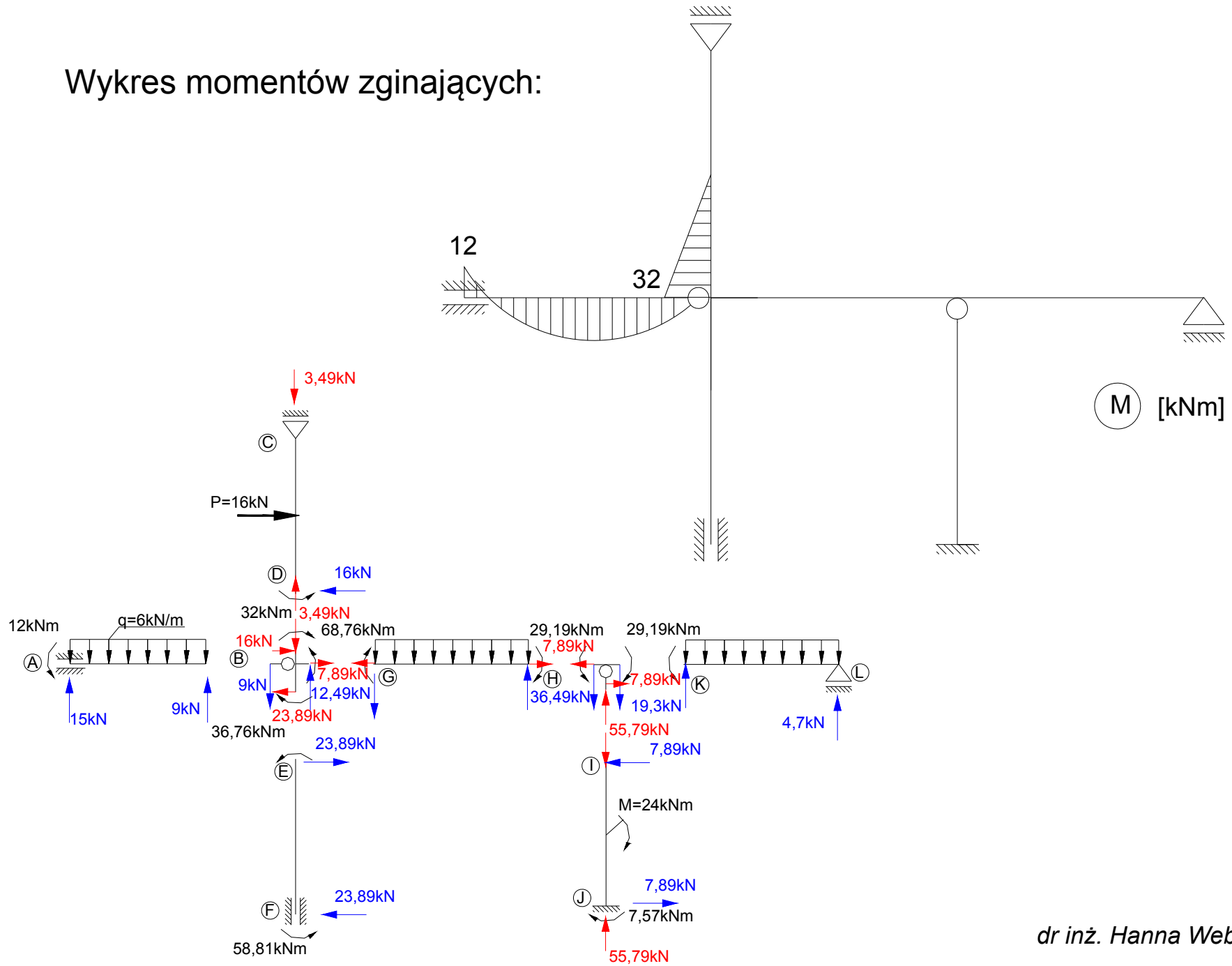

dr inż. Hanna Weber

Wykres momentów zginających:

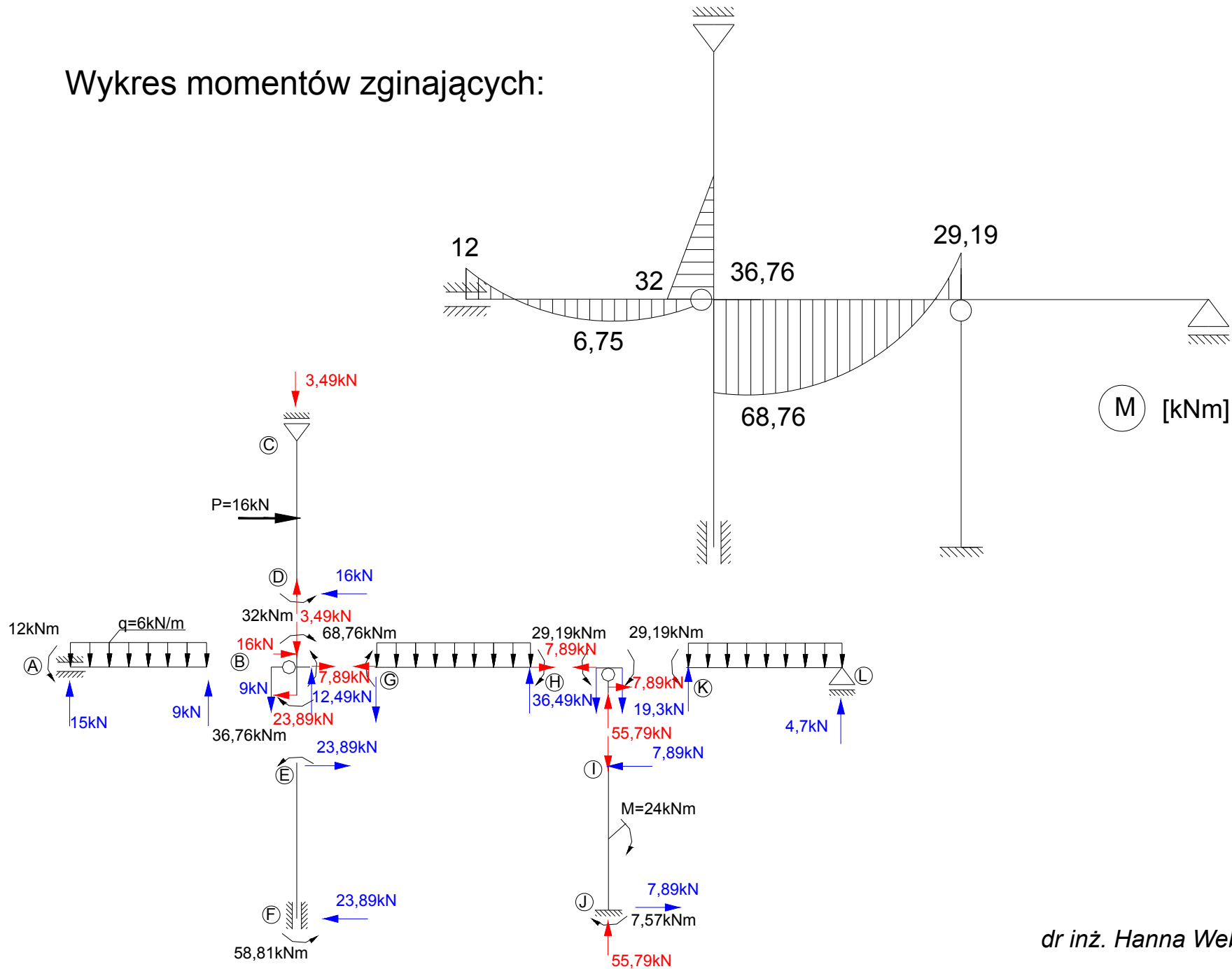

dr inż. Hanna Weber

Wykres momentów zginających:

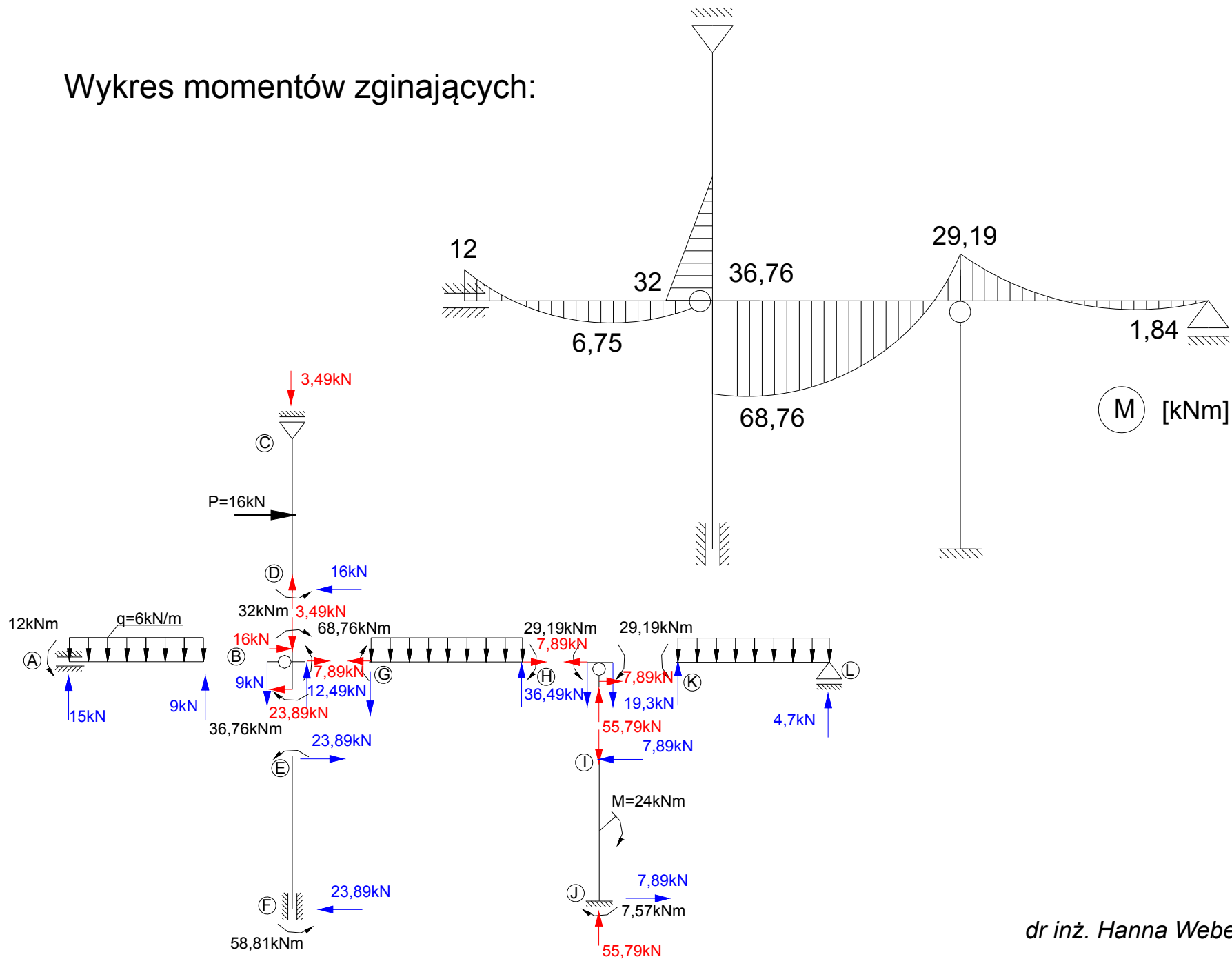

dr inż. Hanna Weber

Wykres momentów zginających:

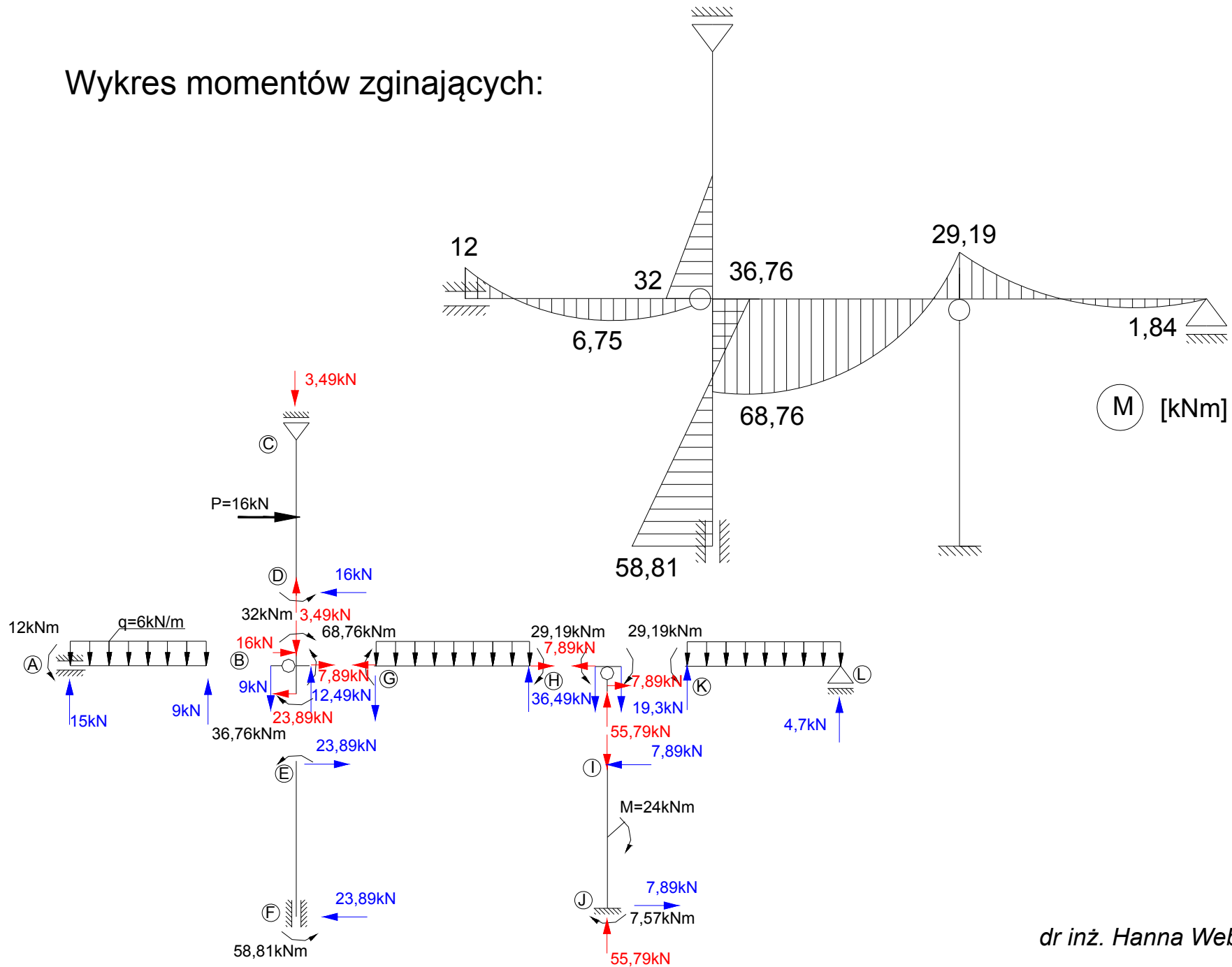

dr inż. Hanna Weber

Wykres momentów zginających:

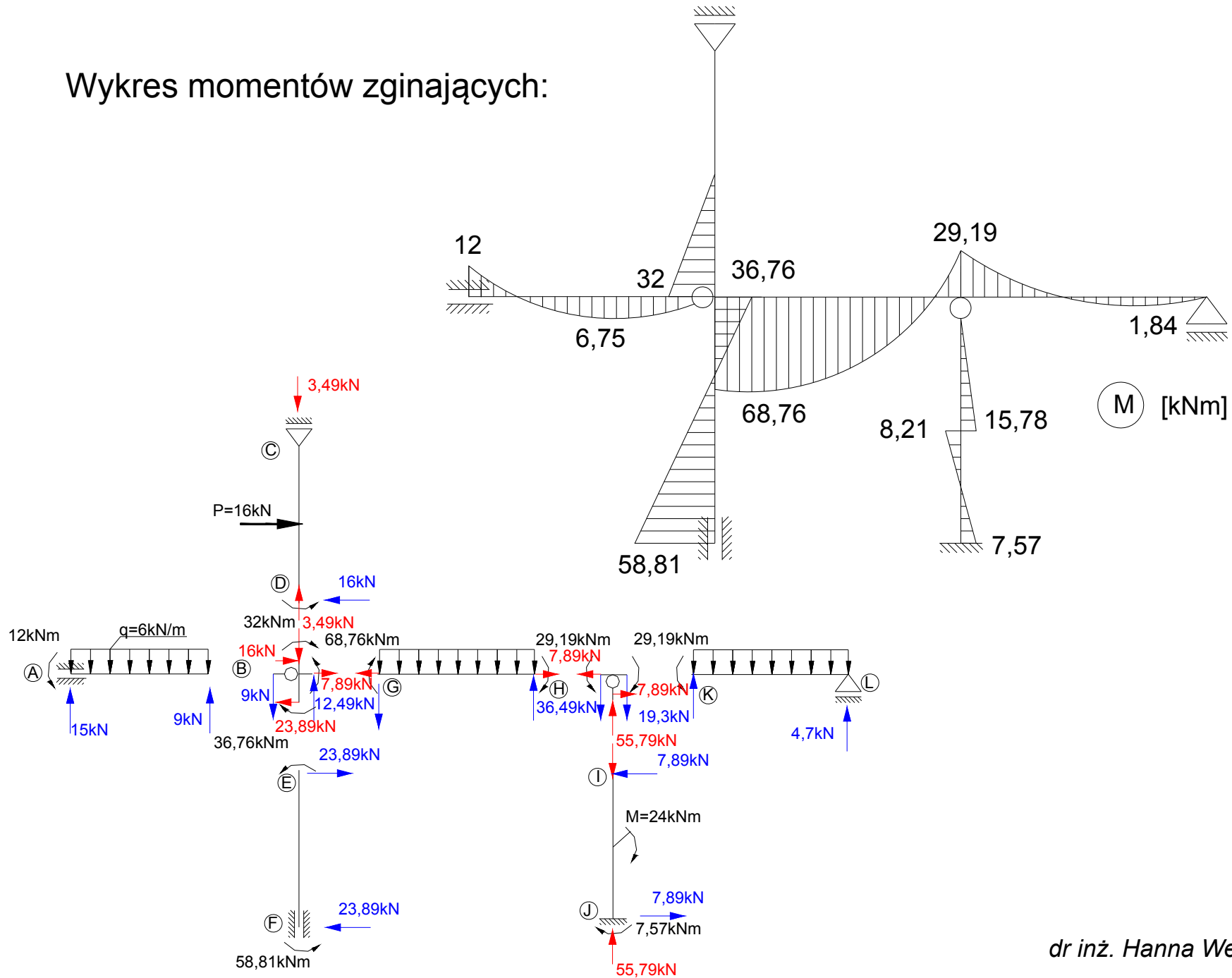

dr inż. Hanna Weber

Sprawdzenie za pomocą twierdzenia redukcyjnego:

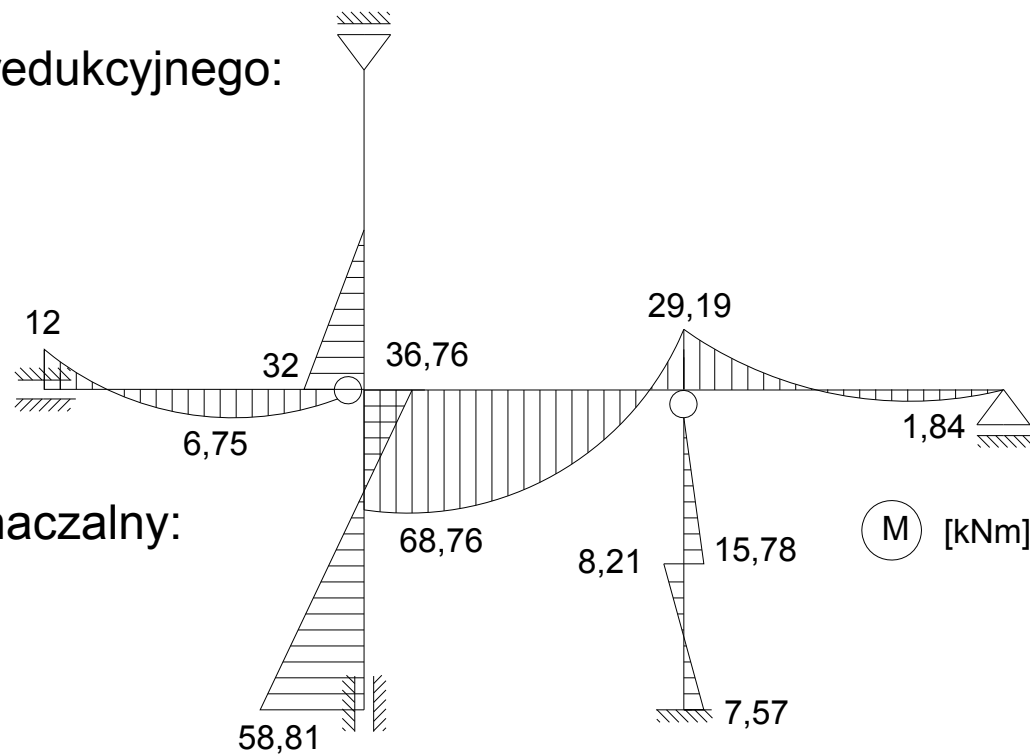

Schemat podstawowy statycznie wyznaczalny:

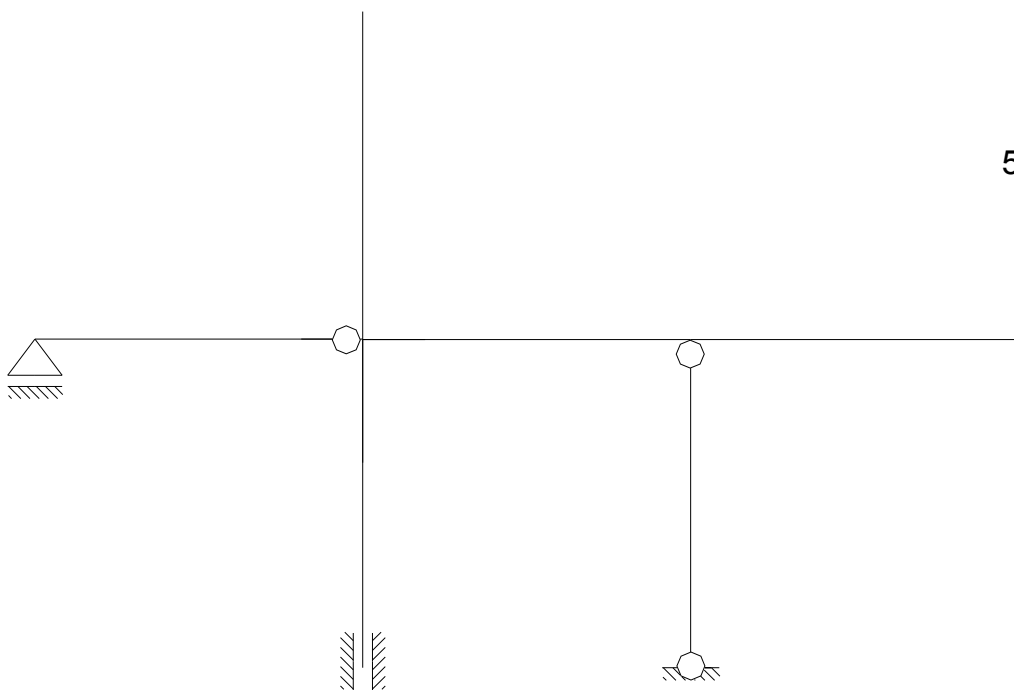

Sprawdzenie za pomocą twierdzenia redukcyjnego:

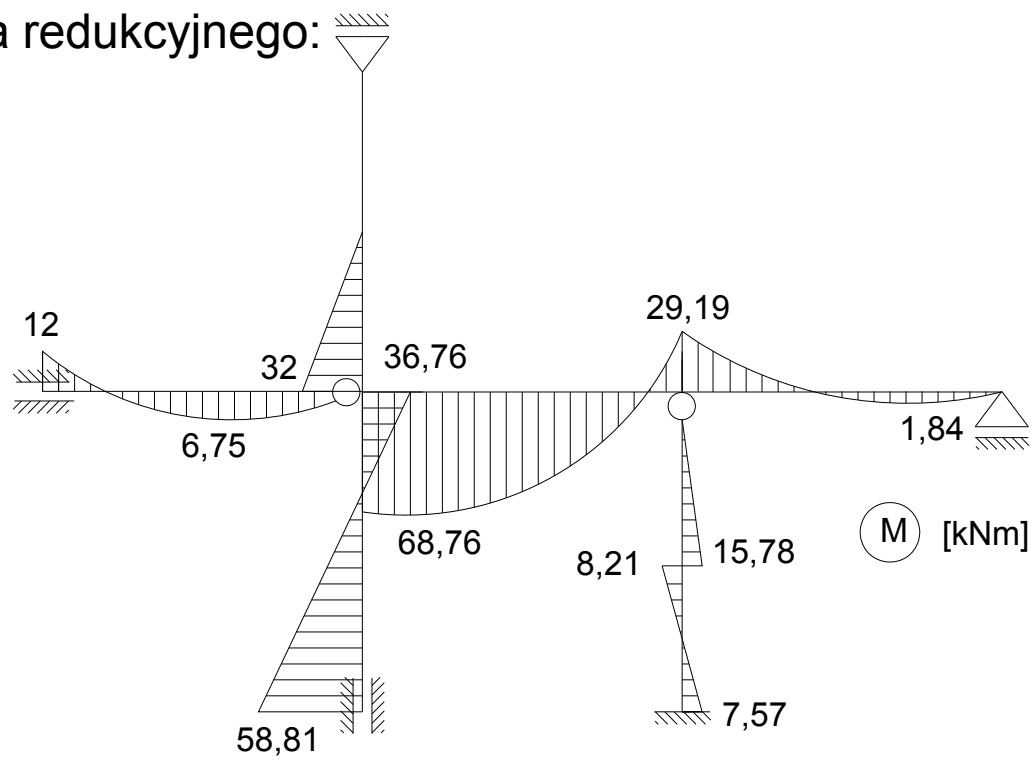

Obciążenie wirtualne:

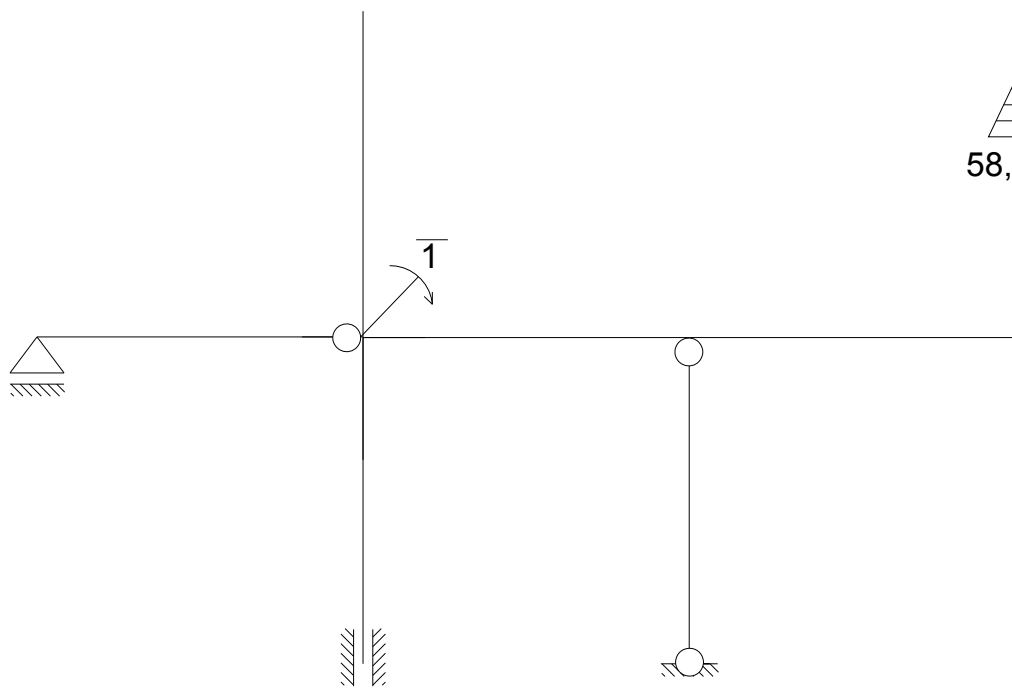

Sprawdzenie za pomocą twierdzenia redukcyjnego:

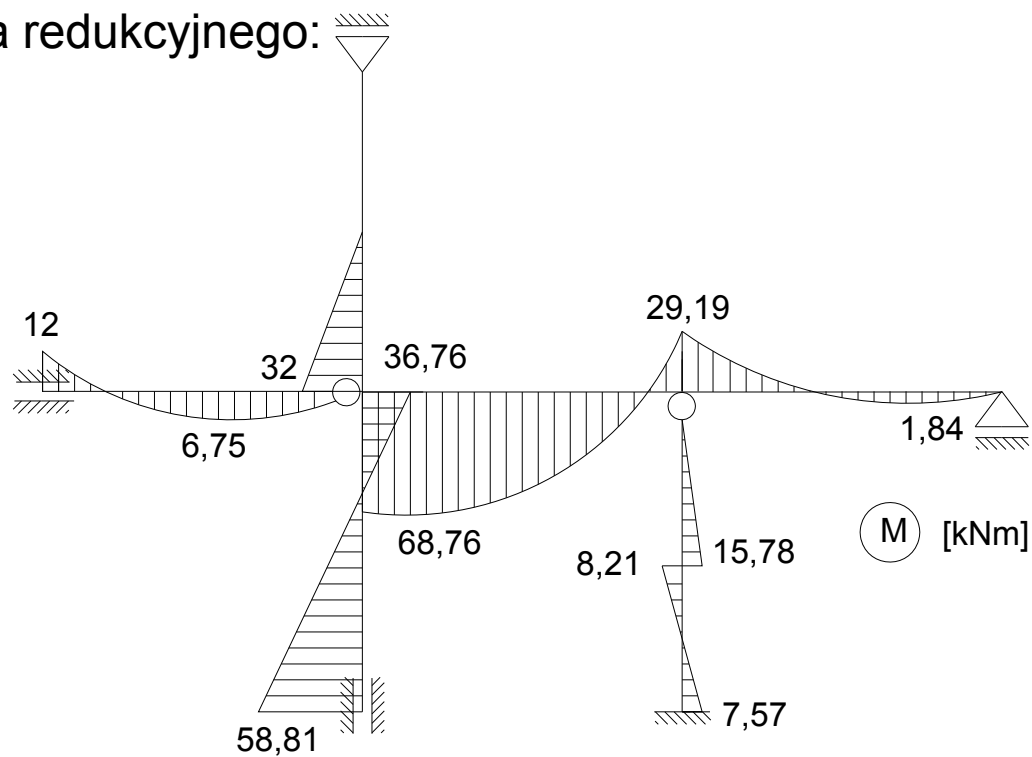

Wykres momentów na schemacie podstawowym:

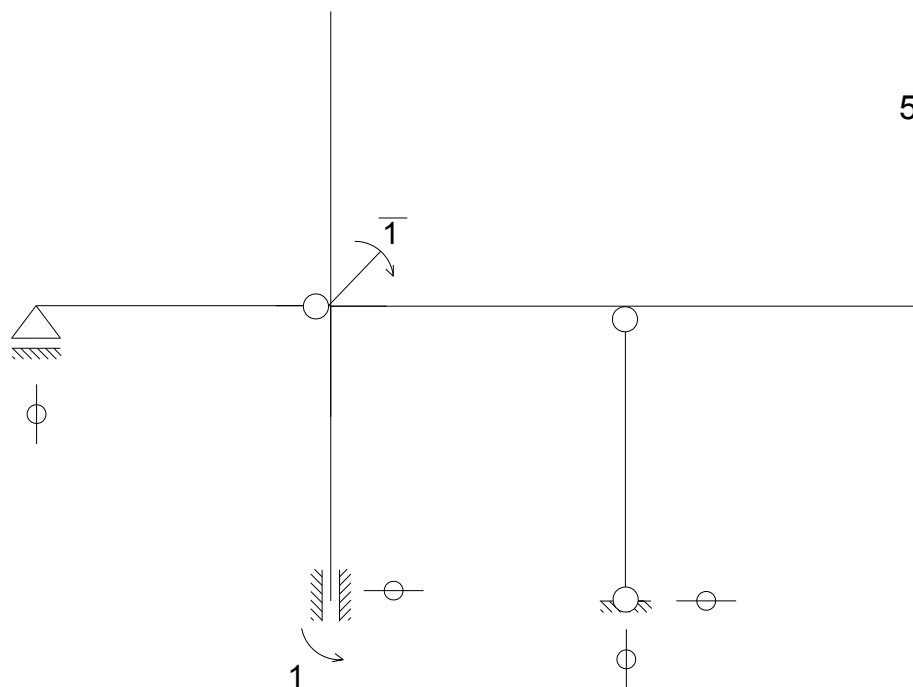

Sprawdzenie za pomocą twierdzenia redukcyjnego:

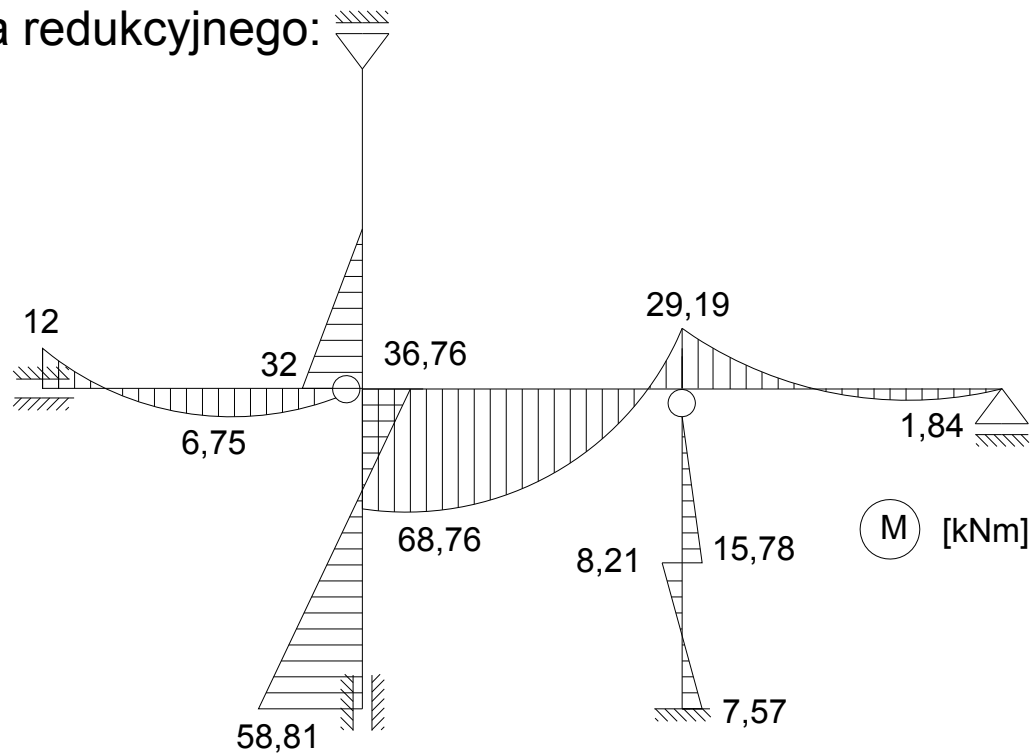

Wykres momentów na schemacie podstawowym:

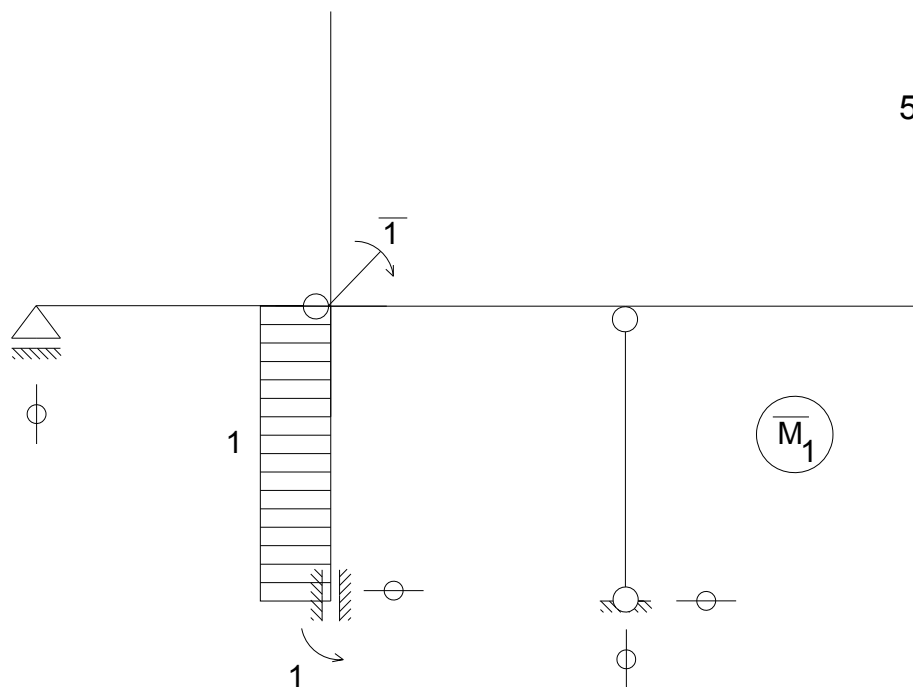

Sprawdzenie za pomocą twierdzenia redukcyjnego:

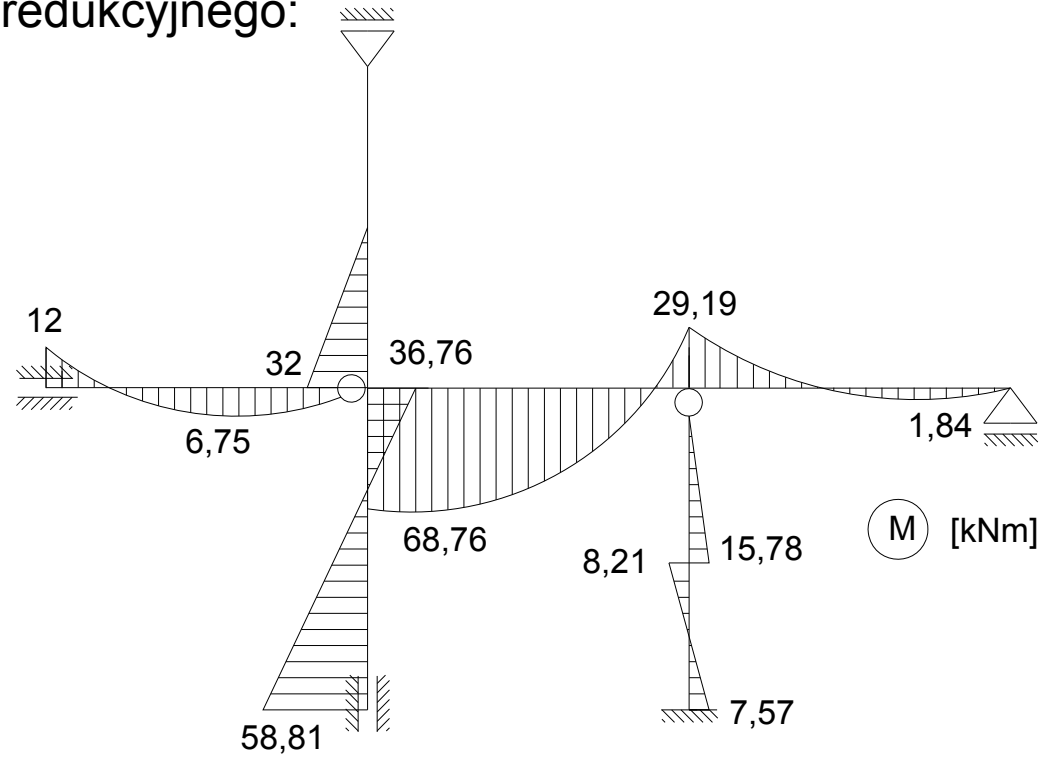

Wykres momentów na schemacie podstawowym:

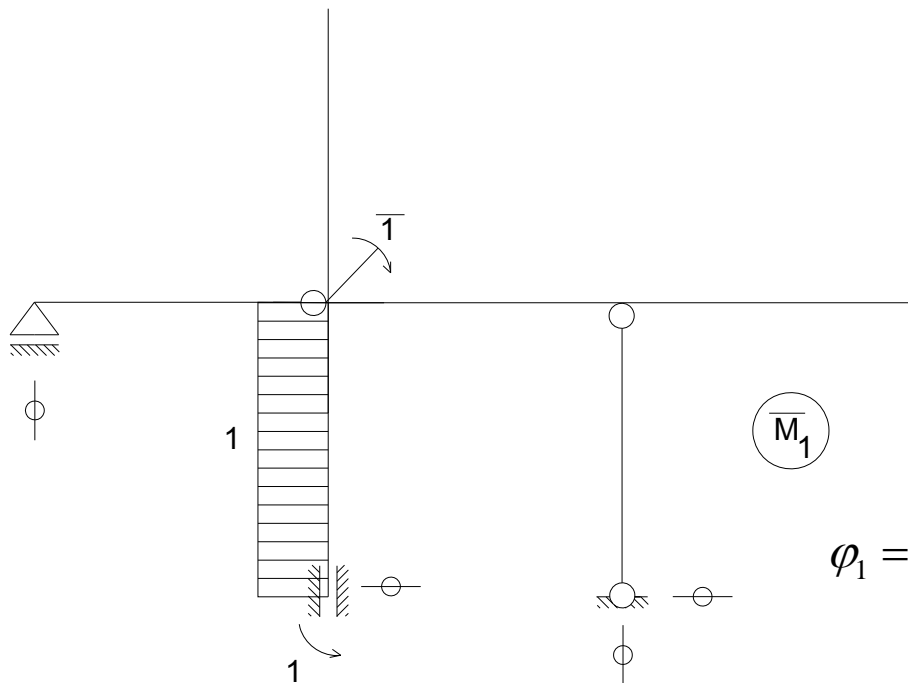

$$\varphi_1 = \frac{1}{EI} (0,5 \cdot 58,81 \cdot 4 \cdot 1 + 0,5 \cdot 36,76 \cdot 4 \cdot (-1)) = \frac{44,10}{EI}$$

dr inż. Hanna Weber