

Zadanie: Narysuj odkształconą postać ramy. Poszczególne przemieszczenia wyznacz z zasady prac wirtualnych.

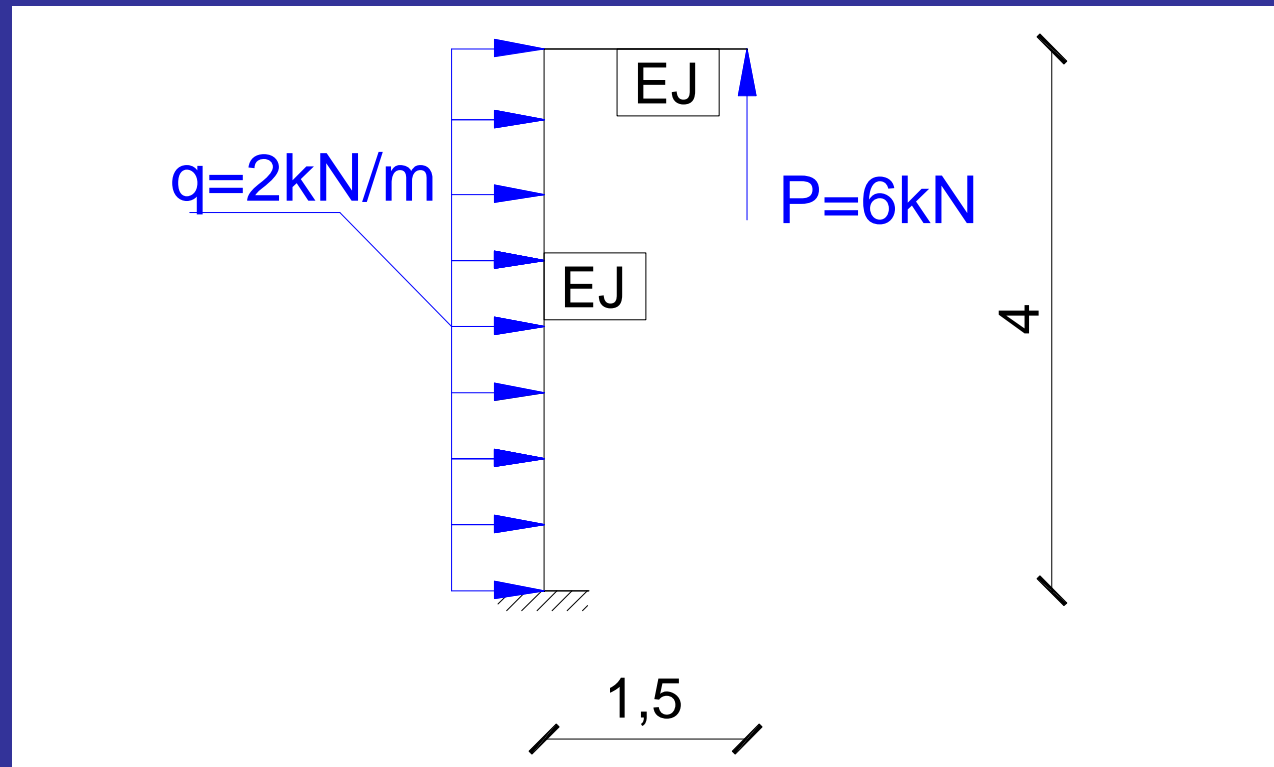

dr inż. Hanna Weber

Wyznaczenie reakcji

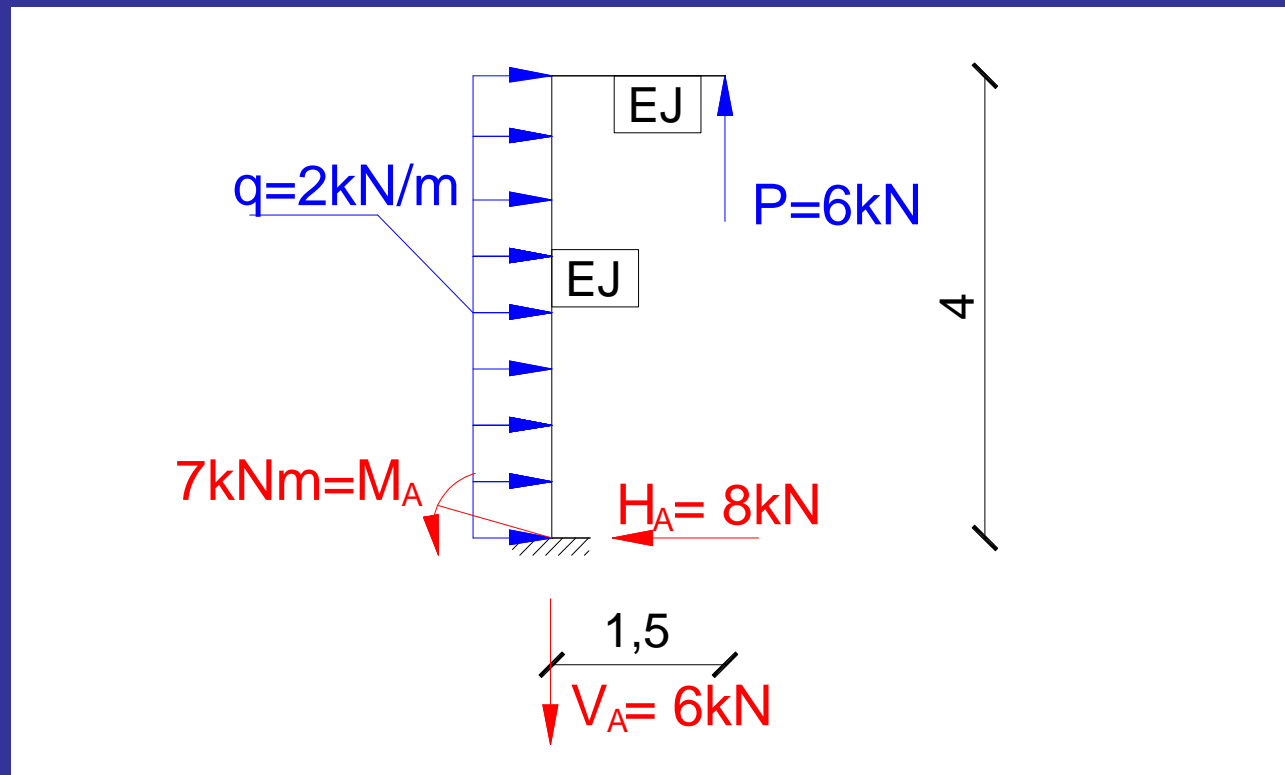

dr inż. Hanna Weber

Wykresy sił wewnętrznych

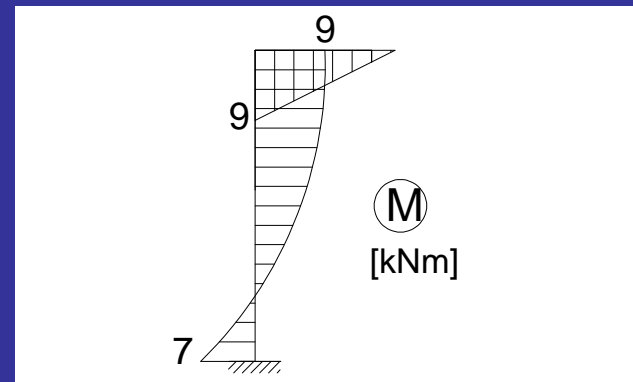
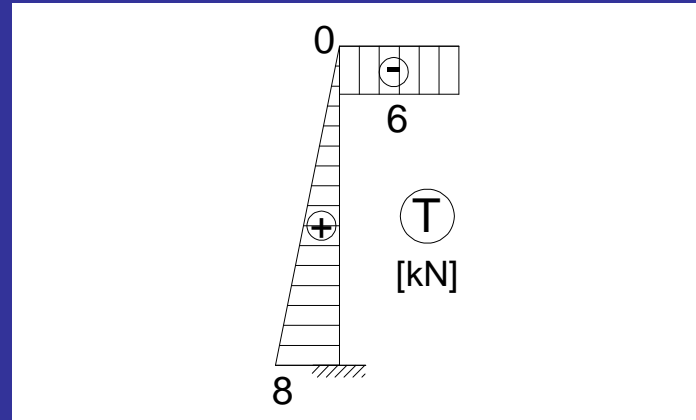
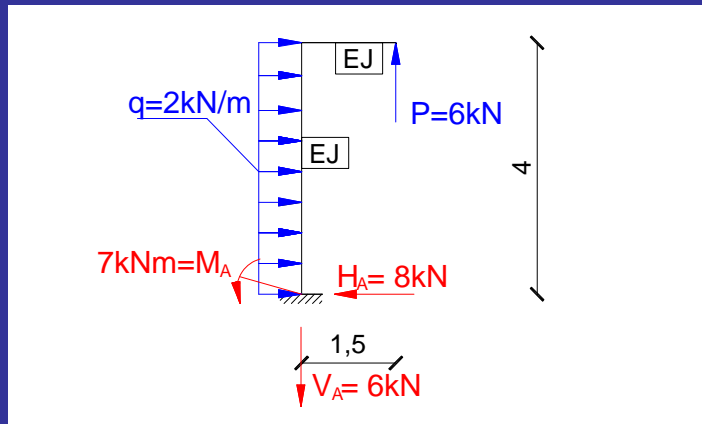

dr inż. Hanna Weber

Możliwe przemieszczenia w ramie

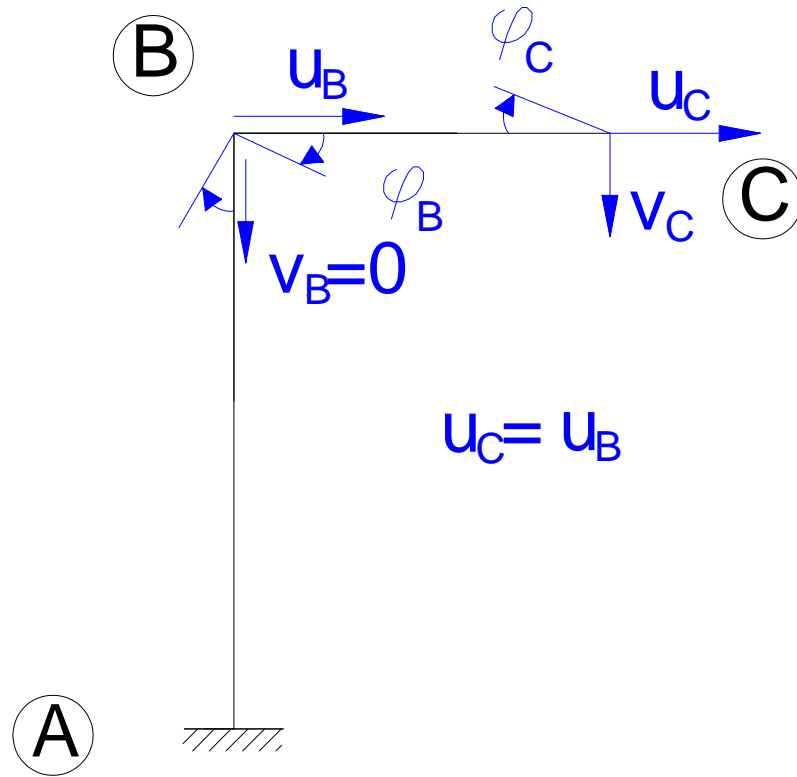

dr inż. Hanna Weber

Wyznaczenie przemieszczeń

Przemieszczenie poziome ramy

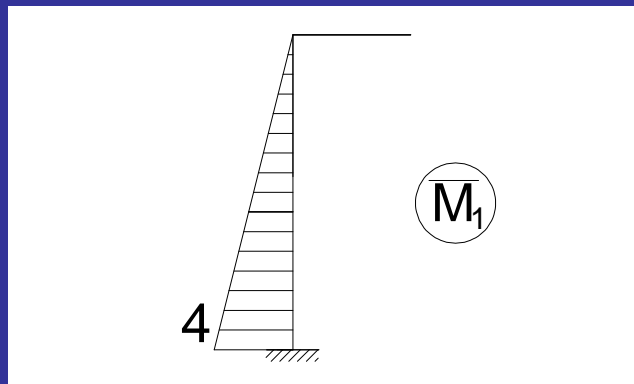
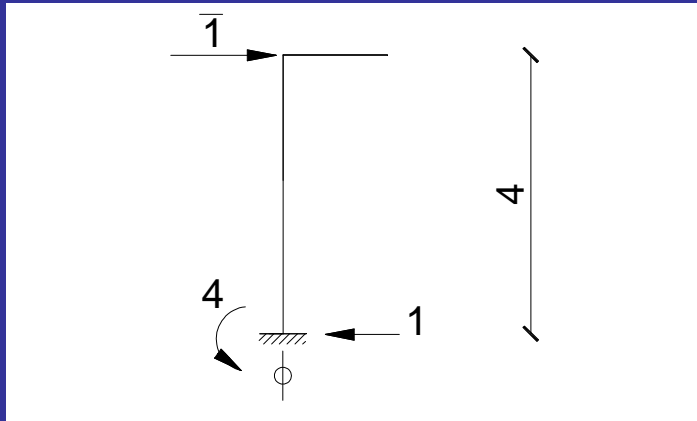

dr inż. Hanna Weber

Wyznaczenie przemieszczeń

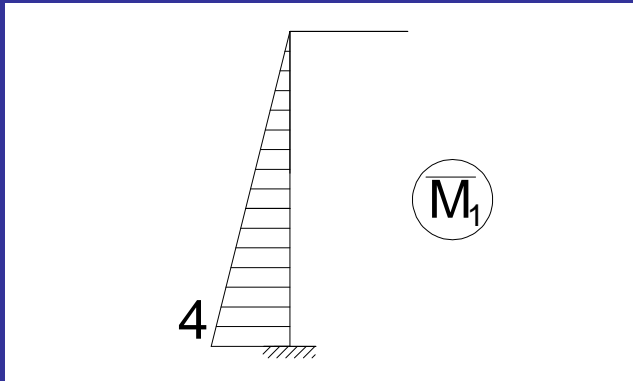

Przemieszczenie poziome ramy

$$u_B = \frac{1}{EI} \left(\frac{1}{2} \cdot 7 \cdot 4 \cdot \frac{2}{3} \cdot 4 - \frac{1}{2} \cdot 9 \cdot 4 \cdot \frac{1}{3} \cdot 4 \right) - \frac{1}{EI} \left(\frac{2}{3} \cdot \frac{2 \cdot 4^2}{8} \cdot 4 \cdot \frac{1}{2} \cdot 4 \right) = \frac{-8}{EI}$$

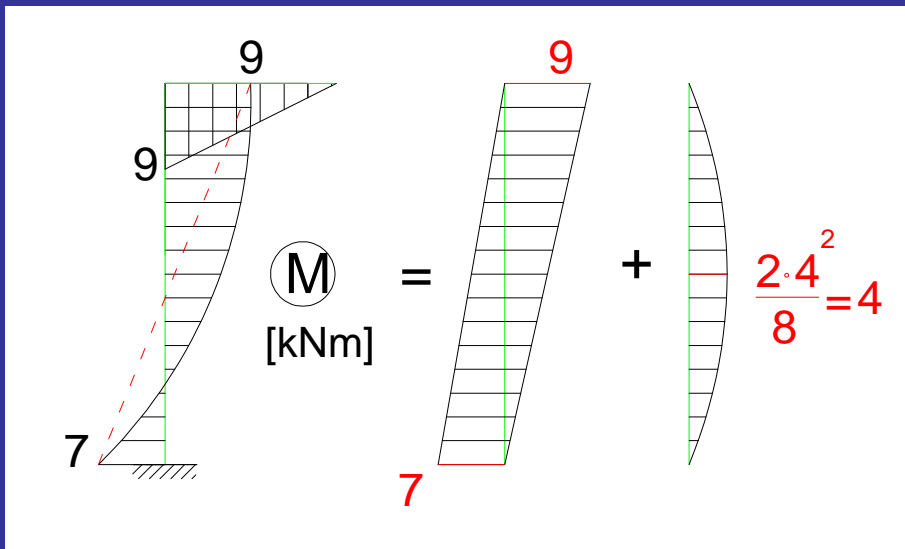

dr inż. Hanna Weber

Wyznaczenie przemieszczeń

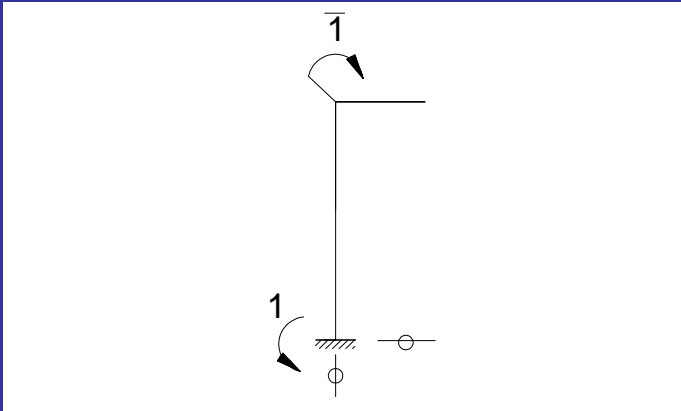

Kąt obrotu w punkcie B

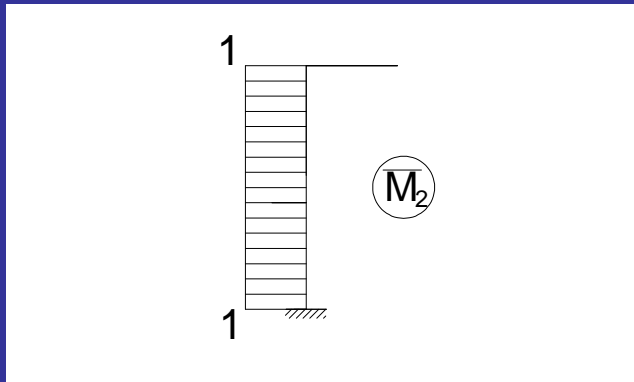

dr inż. Hanna Weber

Wyznaczenie przemieszczeń

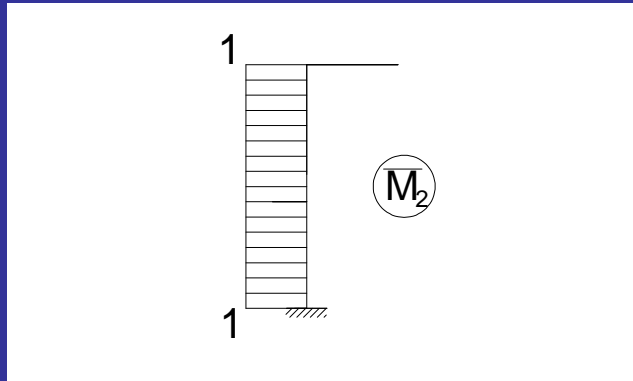

Kąt obrotu w punkcie B

$$\begin{aligned}\varphi_B &= \frac{1}{EI} \left(\frac{1}{2} \cdot 7 \cdot 4 \cdot 1 - \frac{1}{2} \cdot 9 \cdot 4 \cdot 1 \right) \\ &= -\frac{1}{EI} \left(\frac{2}{3} \cdot \frac{2 \cdot 4^2}{8} \cdot 4 \cdot 1 \right) \\ &= \frac{-44}{3EI} = \frac{-14,66}{EI}\end{aligned}$$

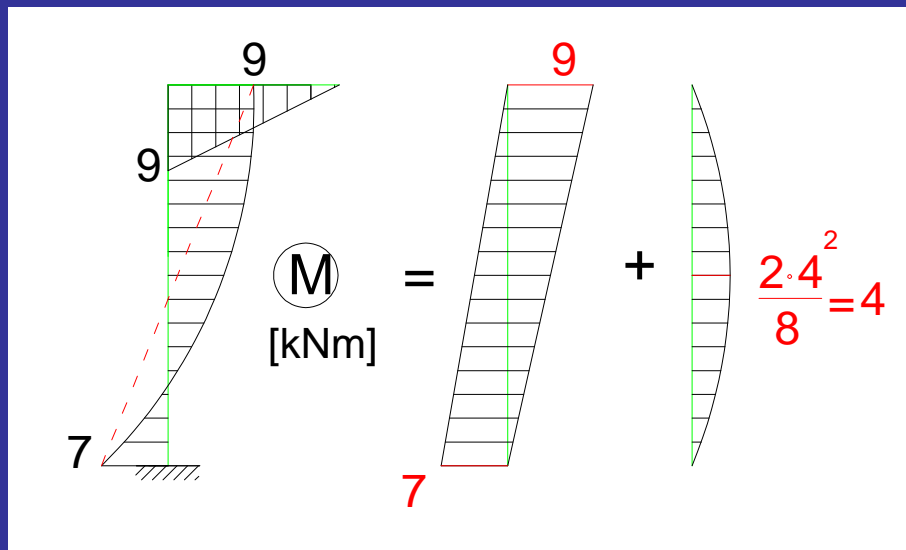

dr inż. Hanna Weber

Wyznaczenie przemieszczeń

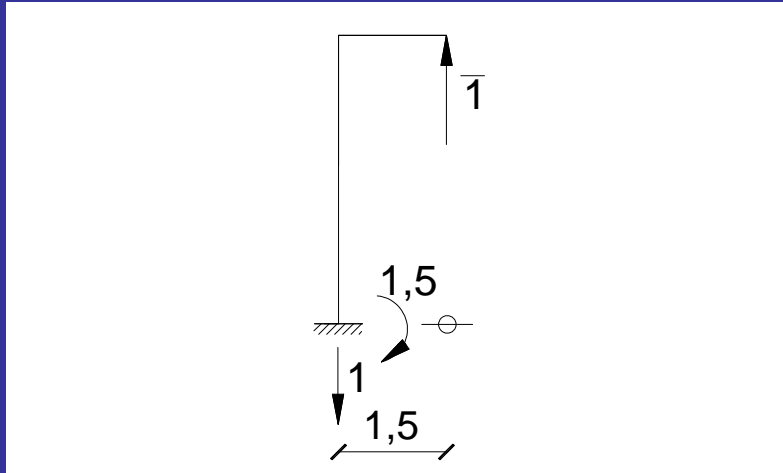

Przemieszczenie pionowe
końca wspornika

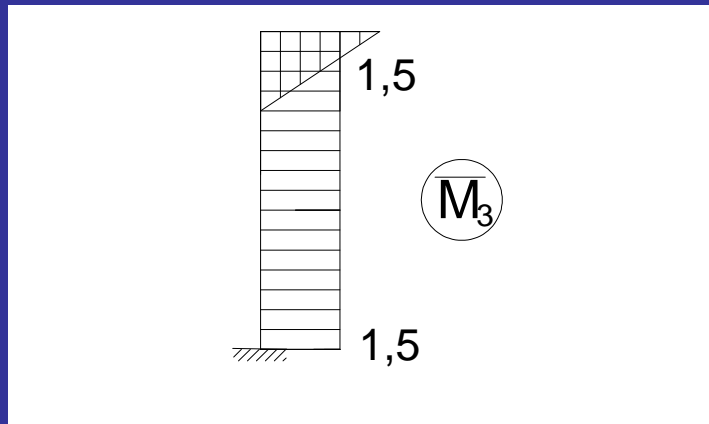

dr inż. Hanna Weber

Wyznaczenie przemieszczeń

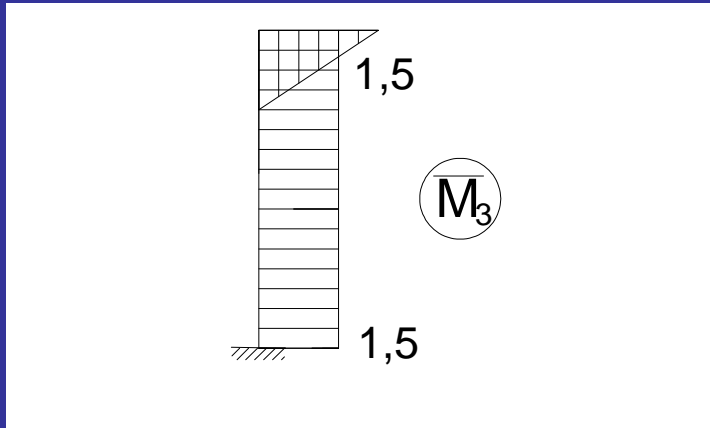

Przemieszczenie pionowe
końca wspornika

$$v_c = \frac{1}{EI} \left(-\frac{1}{2} \cdot 7 \cdot 4 \cdot 1,5 + \frac{1}{2} \cdot 9 \cdot 4 \cdot 1,5 \right) + \frac{1}{EI} \left(\frac{2}{3} \cdot \frac{2 \cdot 4^2}{8} \cdot 4 \cdot 1,5 + \frac{1}{2} \cdot 9 \cdot 1,5 \cdot \frac{2}{3} \cdot 1,5 \right) = \frac{115}{4EI} = \frac{28,75}{EI}$$

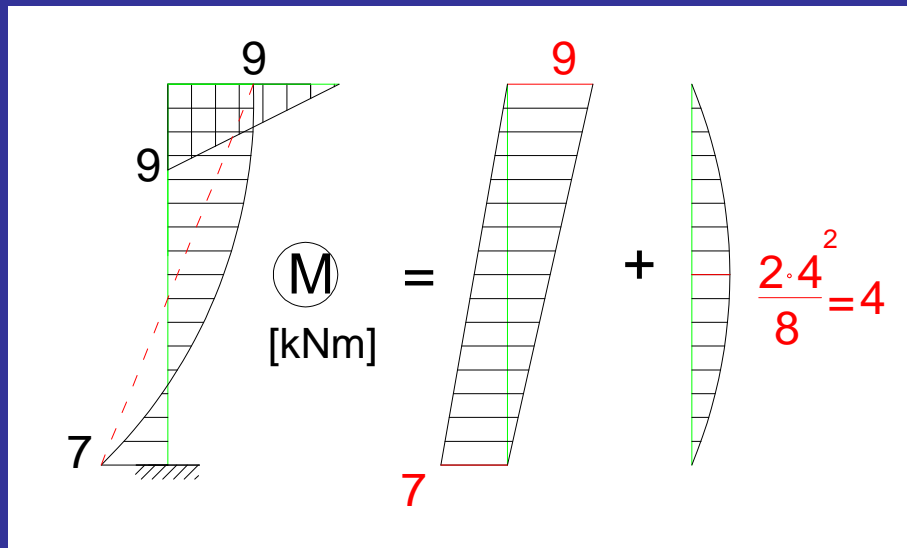

dr inż. Hanna Weber

Wyznaczenie przemieszczeń

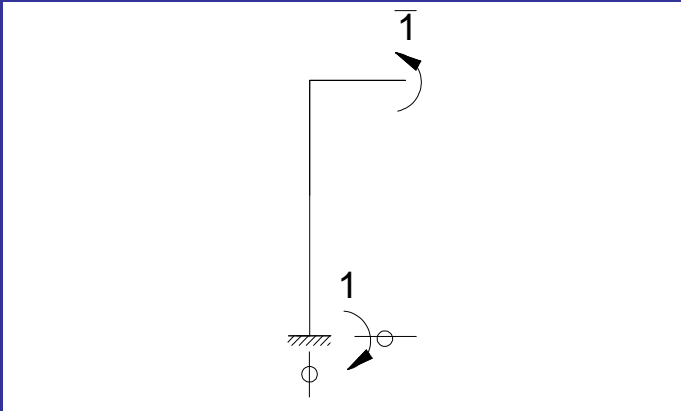

Kąt obrotu na końcu wspornika

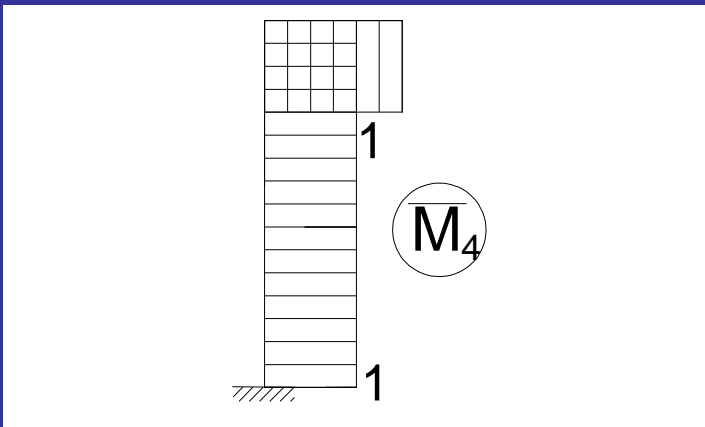

dr inż. Hanna Weber

Wyznaczenie przemieszczeń

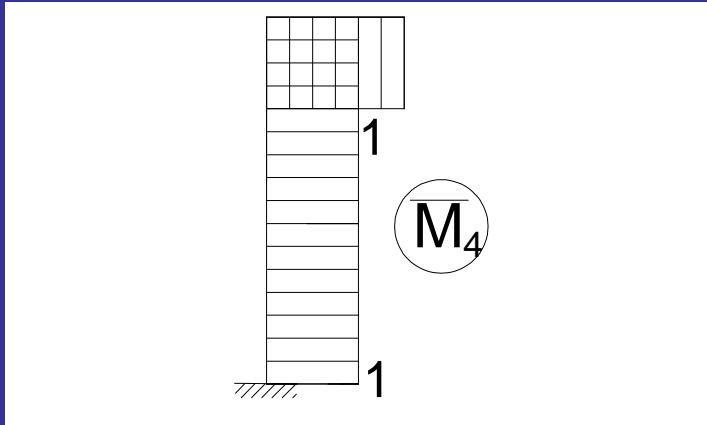

Kąt obrotu na końcu wspornika

$$\begin{aligned} \varphi_c &= \frac{1}{EI} \left(-\frac{1}{2} \cdot 7 \cdot 4 \cdot 1 + \frac{1}{2} \cdot 9 \cdot 4 \cdot 1 \right) \\ &+ \frac{1}{EI} \left(\frac{2}{3} \cdot \frac{2 \cdot 4^2}{8} \cdot 4 \cdot 1 + \frac{1}{2} \cdot 9 \cdot 1,5 \cdot 1 \right) \\ &= \frac{257}{12EI} = \frac{21,62}{EI} \end{aligned}$$

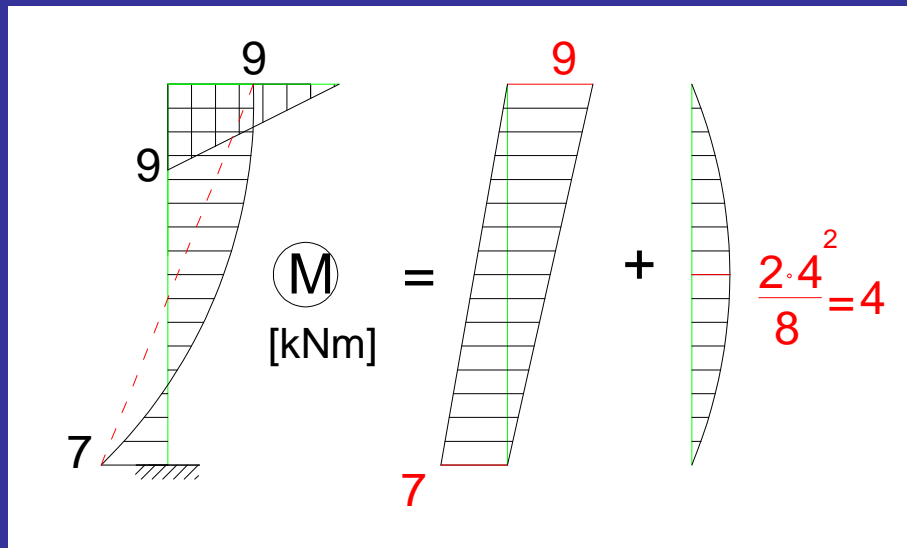

dr inż. Hanna Weber

Odkształcona postać ramy

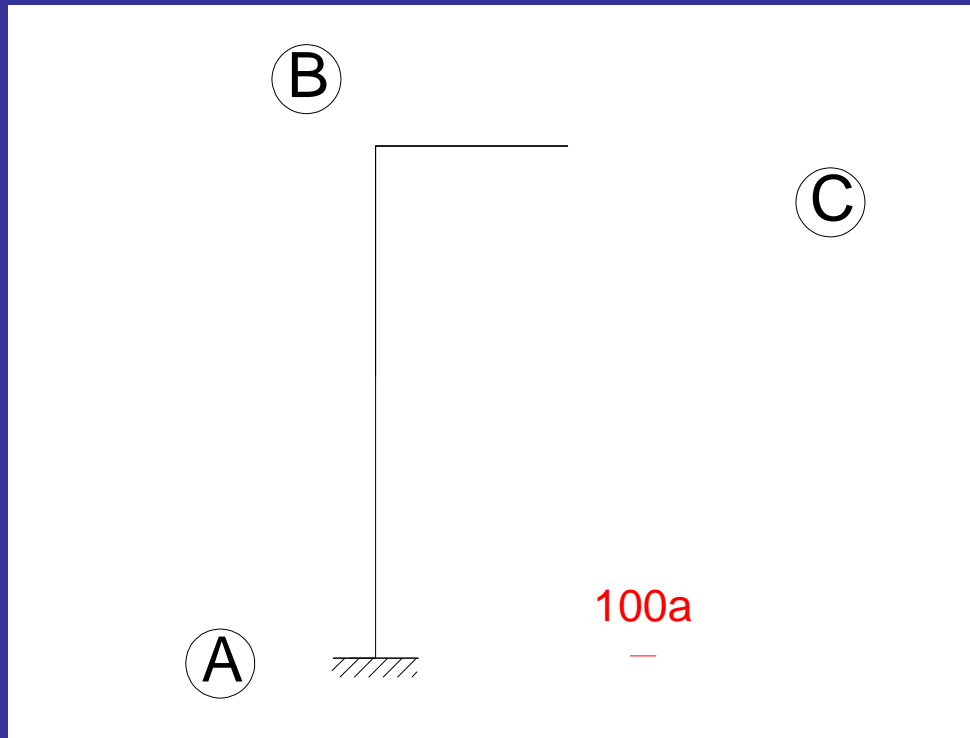

Przemieszczenia:

$$u_B = u_C = -\frac{8}{EI} = -\frac{96}{12EI} = -96a$$

$$\varphi_B = -\frac{44}{3EI} = \frac{-176}{12EI} = -176a$$

$$v_C = \frac{115}{4EI} = \frac{345}{12EI} = 345a$$

$$\varphi_C = \frac{257}{12EI} = 257a$$

dr inż. Hanna Weber

Odształcona postać ramy

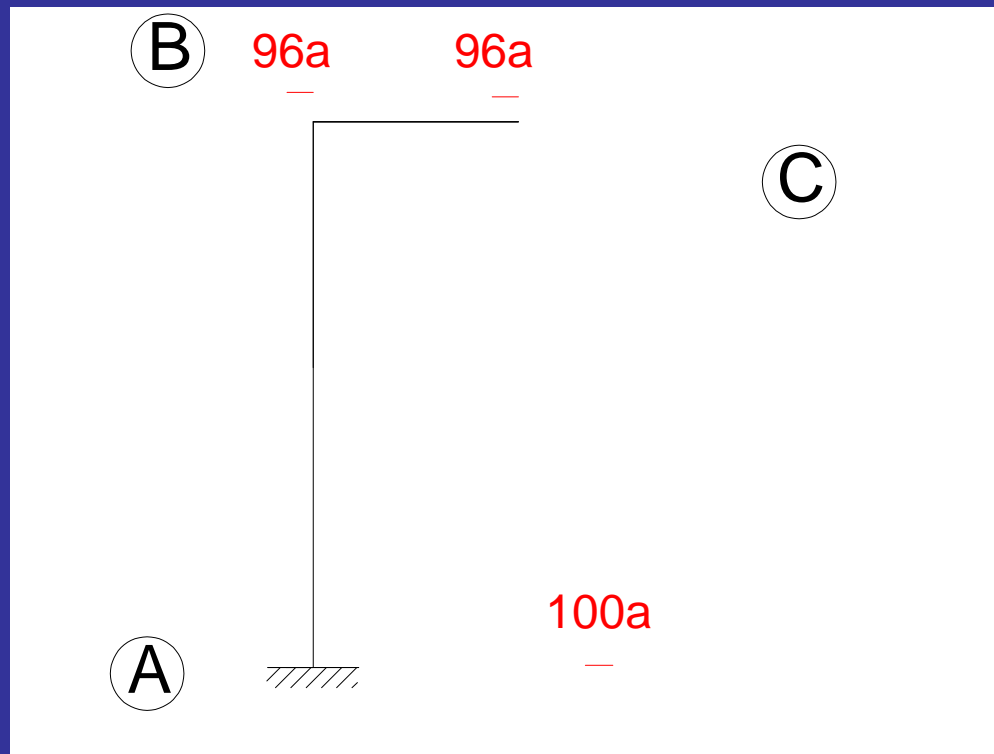

Przemieszczenia:

$$u_B = u_C = -\frac{8}{EI} = -\frac{96}{12EI} = -96a$$

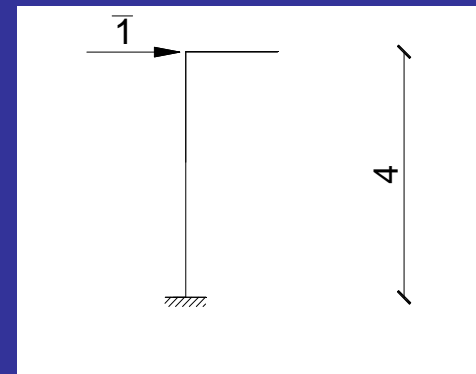

dr inż. Hanna Weber

Odształcona postać ramy

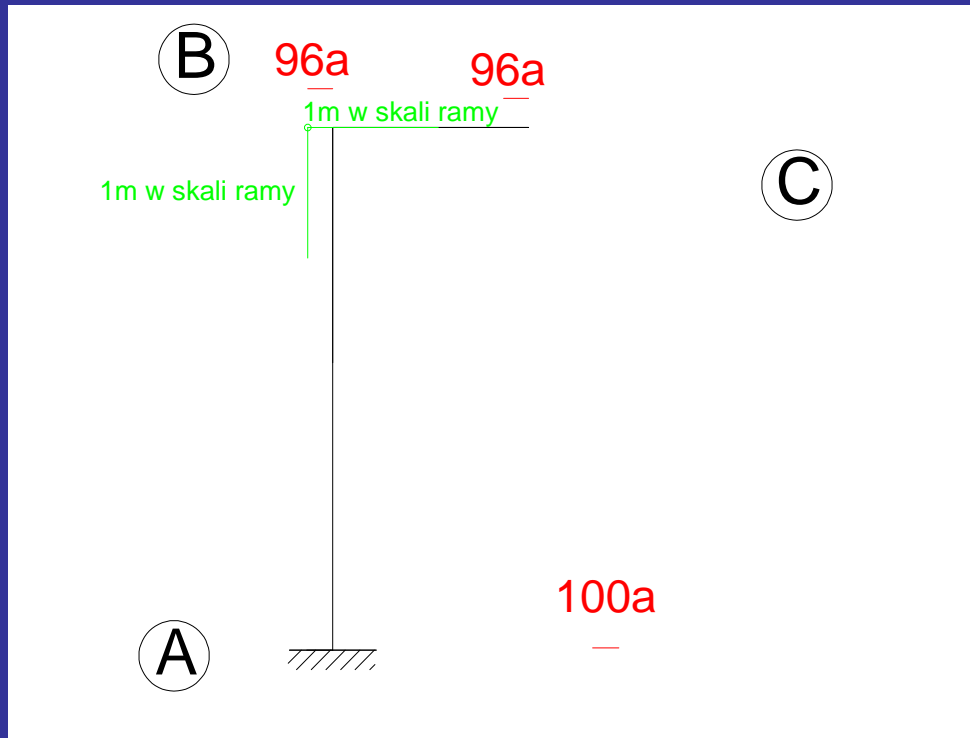

Przemieszczenia:

$$\varphi_B = -\frac{44}{3EI} = \frac{-176}{12EI} = -176a$$

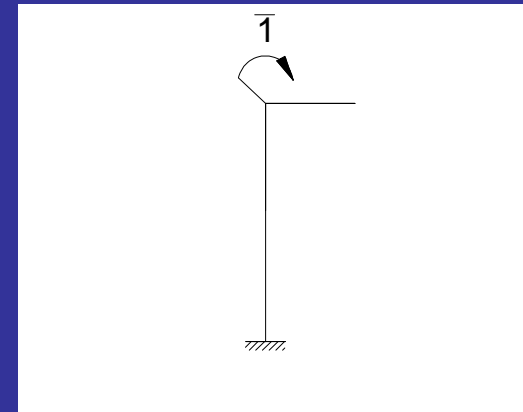

dr inż. Hanna Weber

Odształcona postać ramy

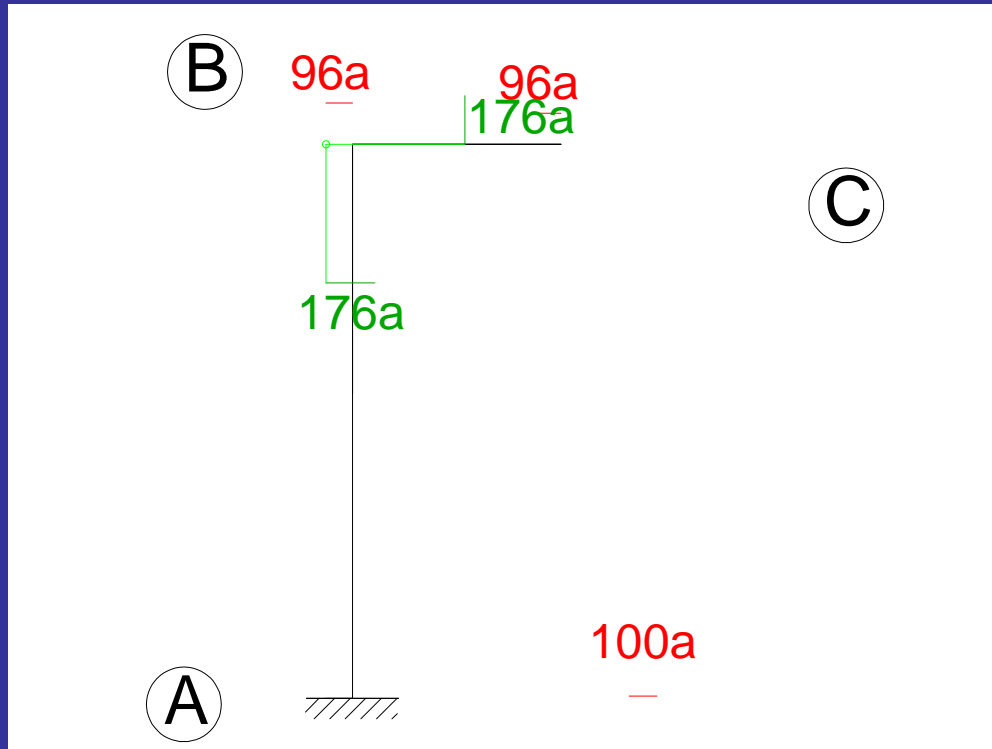

Przemieszczenia:

$$\varphi_B = -\frac{44}{3EI} = \frac{-176}{12EI} = -176a$$

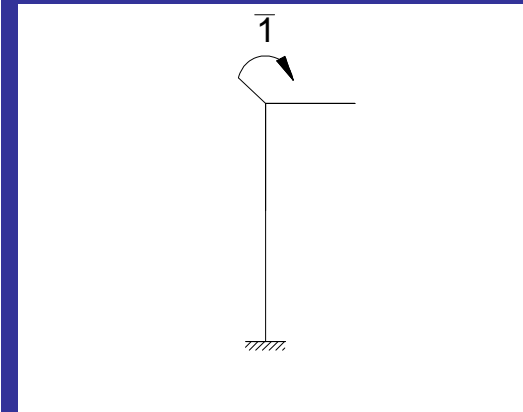

dr inż. Hanna Weber

Odształcona postać ramy

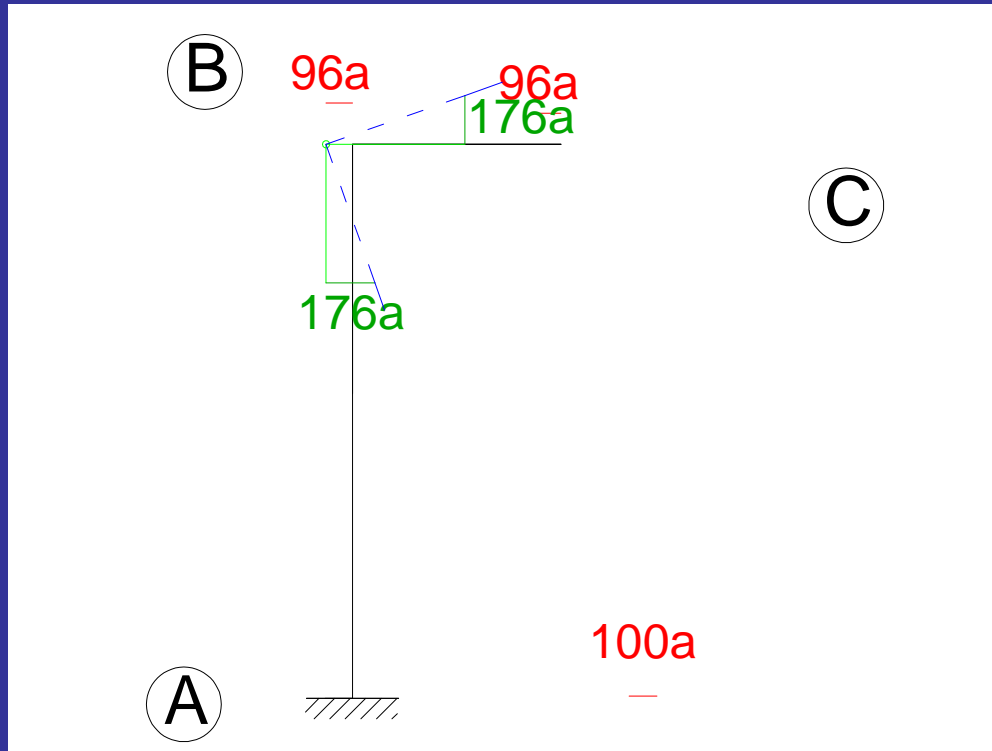

Przemieszczenia:

$$\varphi_B = -\frac{44}{3EI} = \frac{-176}{12EI} = -176a$$

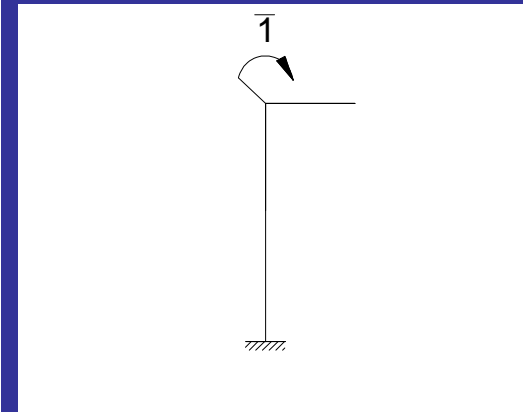

dr inż. Hanna Weber

Odkształcona postać ramy

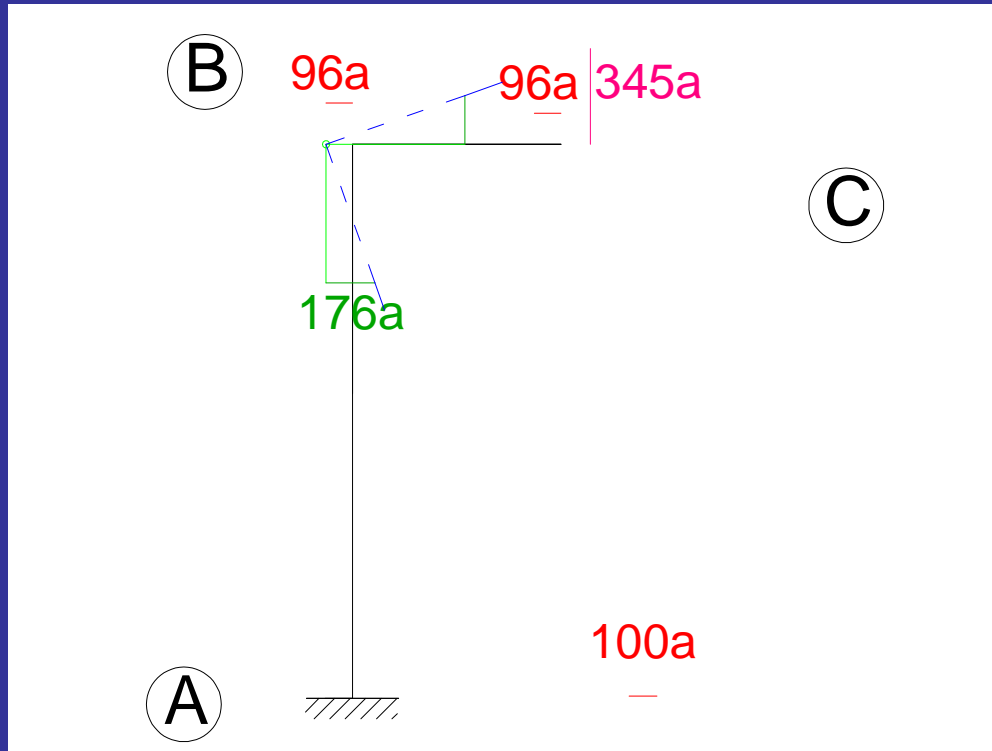

Przemieszczenia:

$$v_C = \frac{115}{4EI} = \frac{345}{12EI} = 345a$$

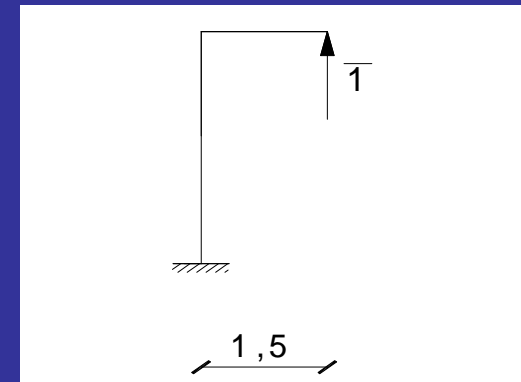

dr inż. Hanna Weber

Odkształcona postać ramy

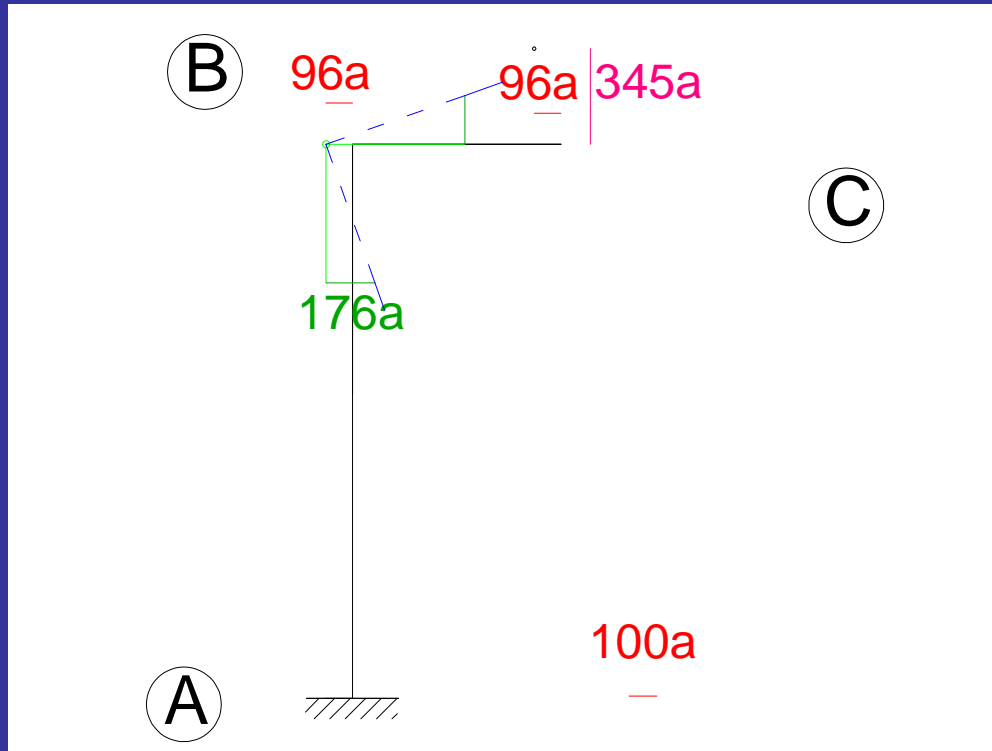

Przemieszczenia:

$$v_C = \frac{115}{4EI} = \frac{345}{12EI} = 345a$$

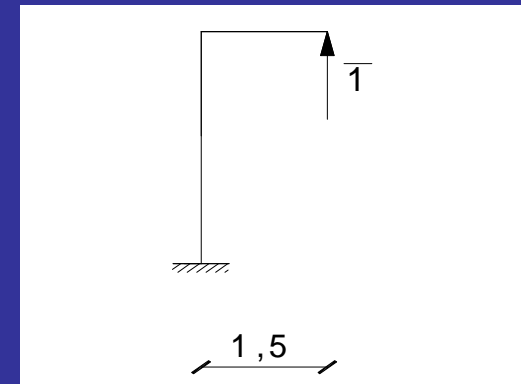

dr inż. Hanna Weber

Odształcona postać ramy

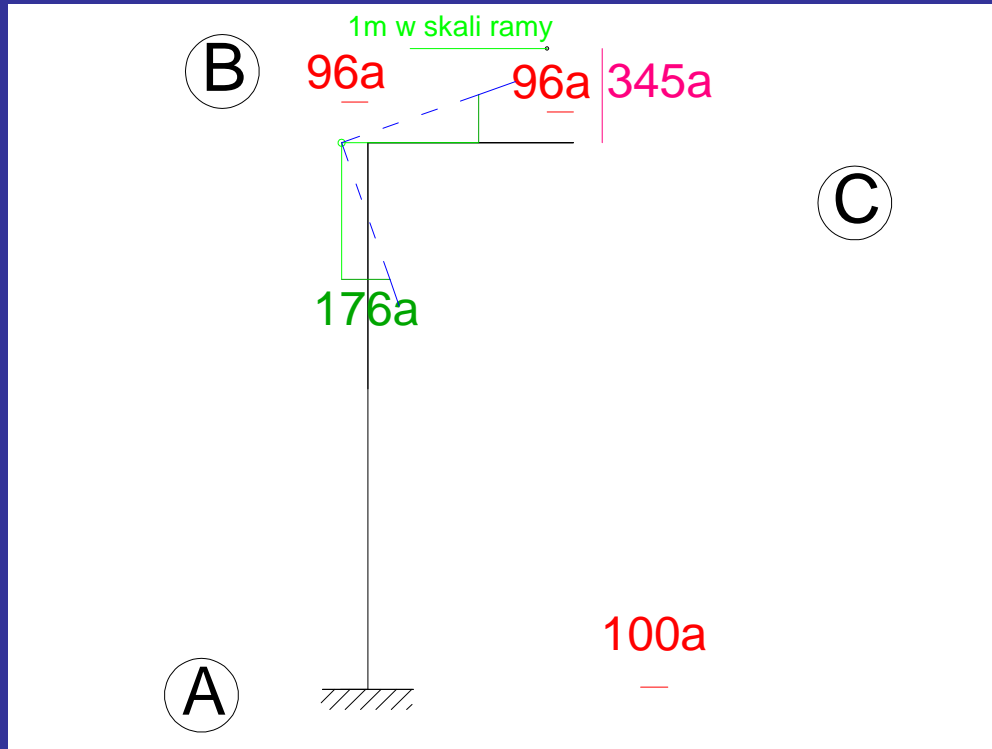

Przemieszczenia:

$$\varphi_C = \frac{257}{12EI} = 257a$$

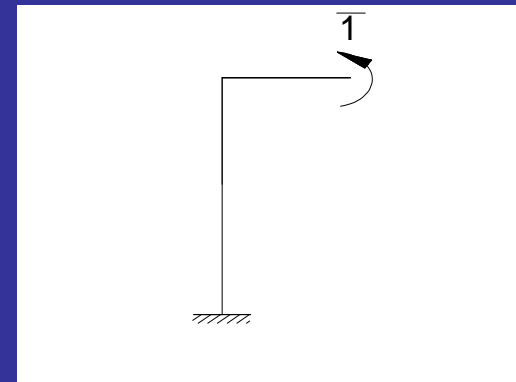

dr inż. Hanna Weber

Odształcona postać ramy

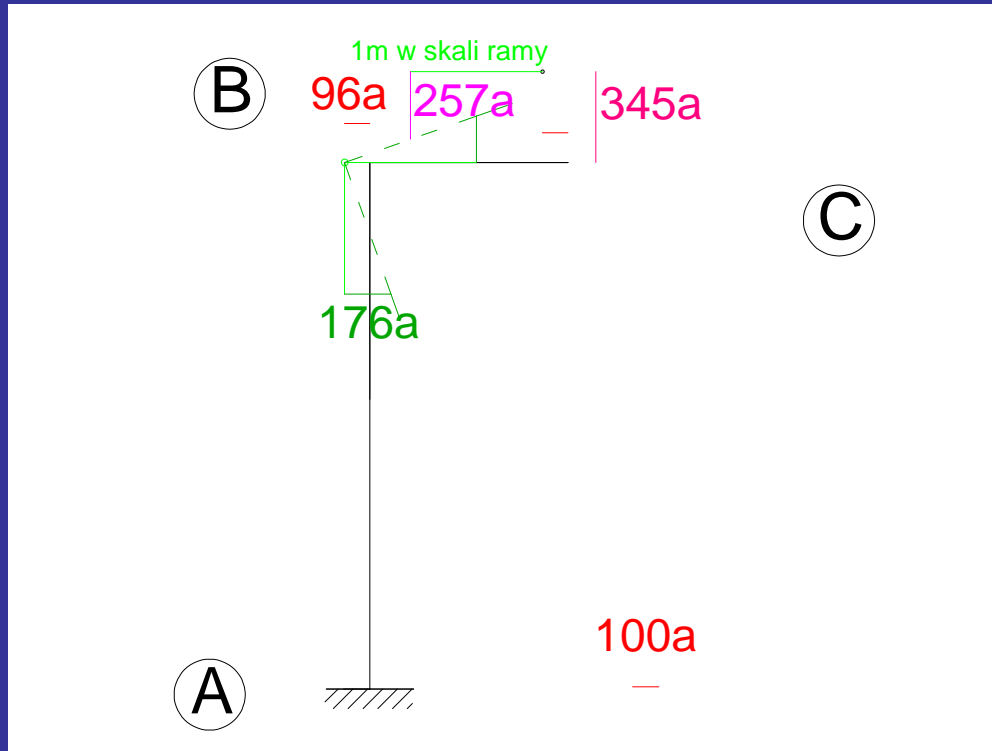

Przemieszczenia:

$$\varphi_C = \frac{257}{12EI} = 257a$$

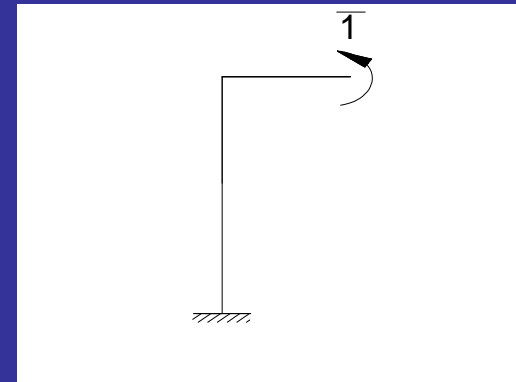

dr inż. Hanna Weber

Odształcona postać ramy

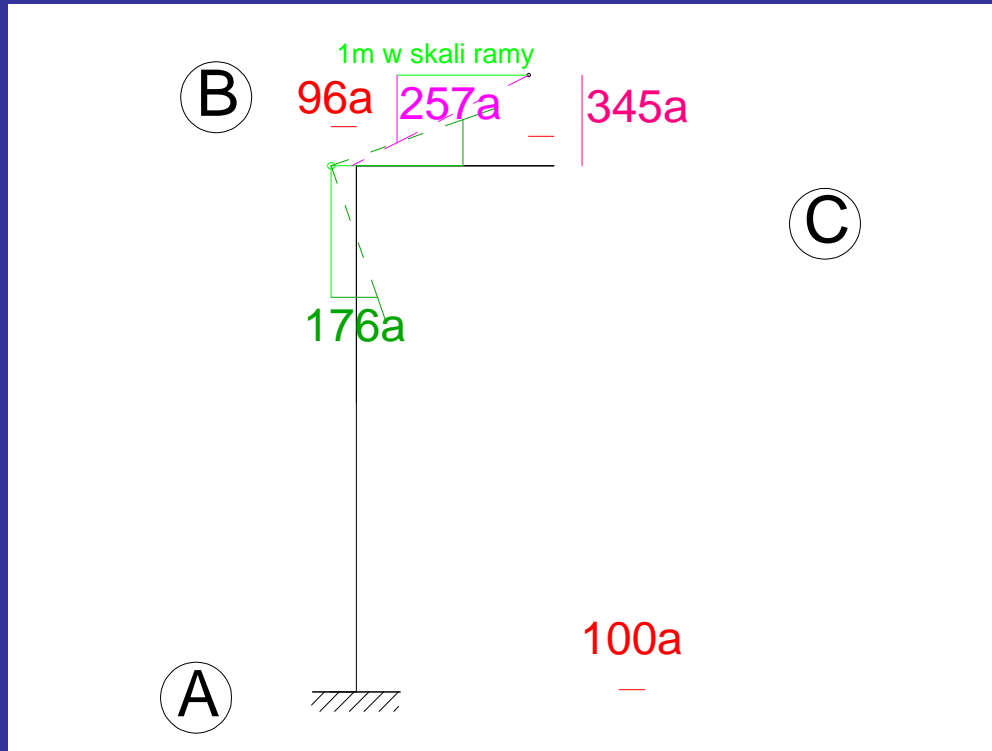

Przemieszczenia:

$$\varphi_C = \frac{257}{12EI} = 257a$$

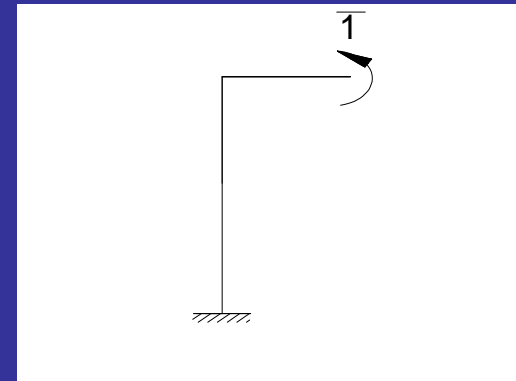

dr inż. Hanna Weber

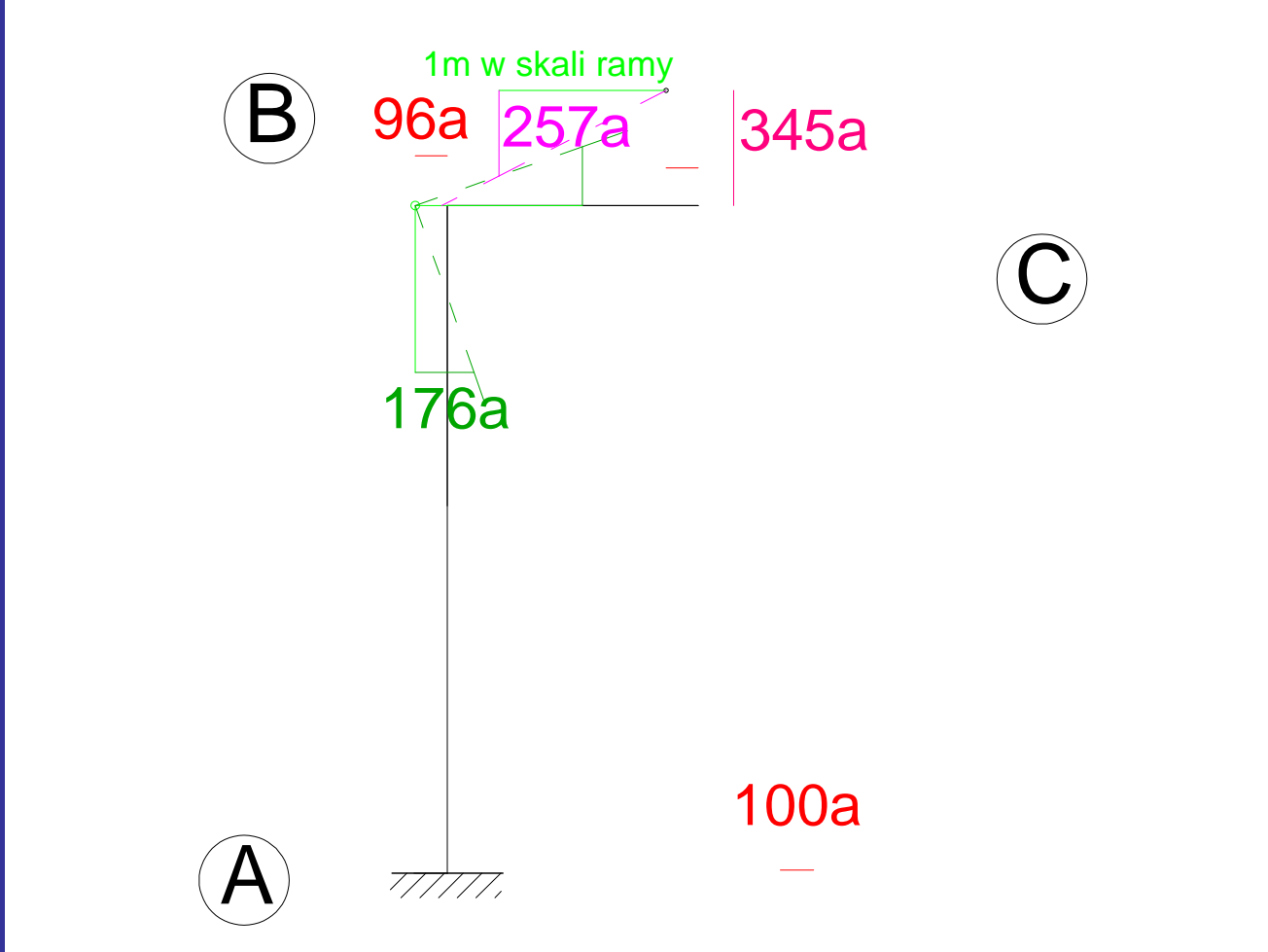

dr inż. Hanna Weber

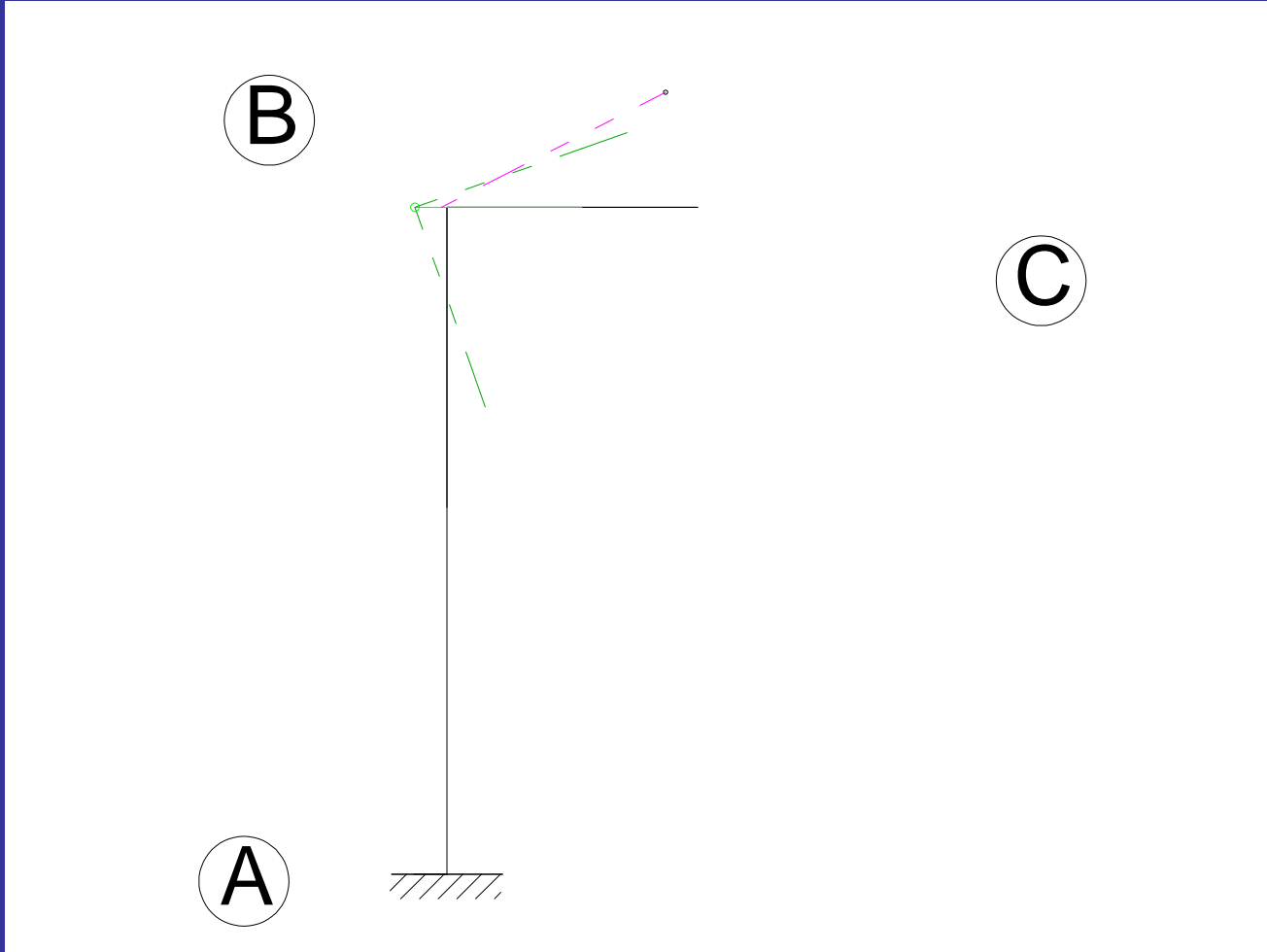

dr inž. Hanna Weber

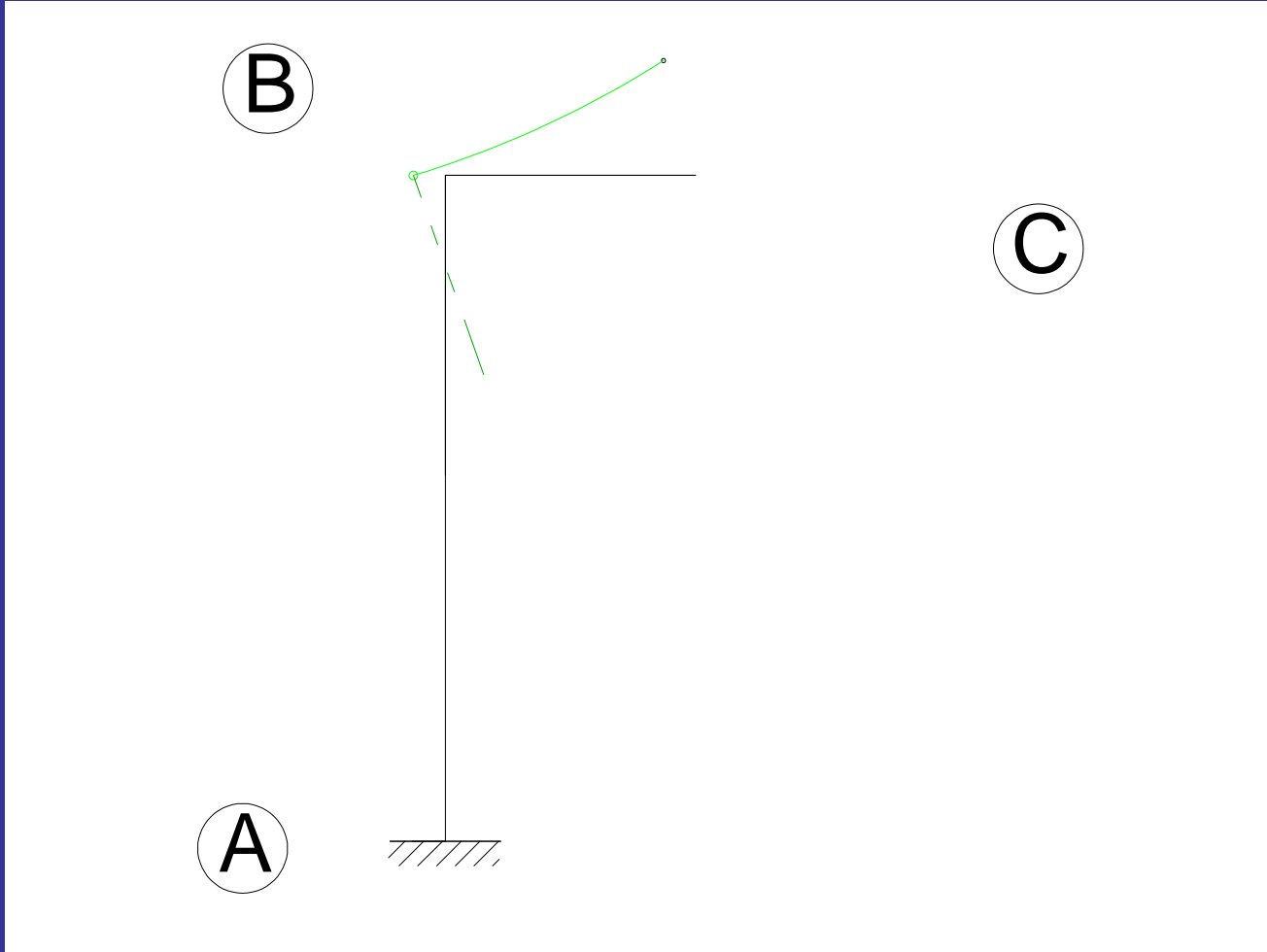

dr inž. Hanna Weber

(B)

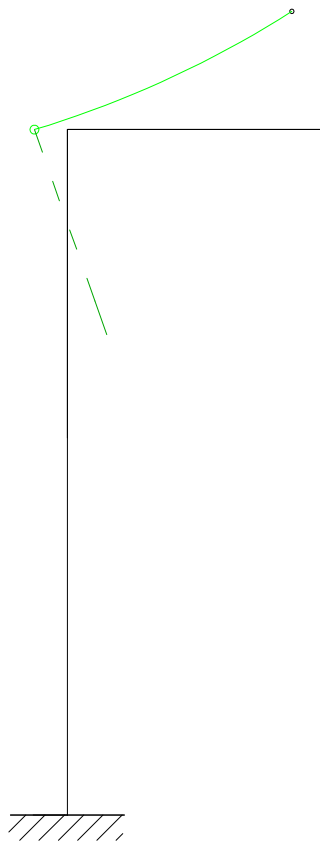

(C)

(A)

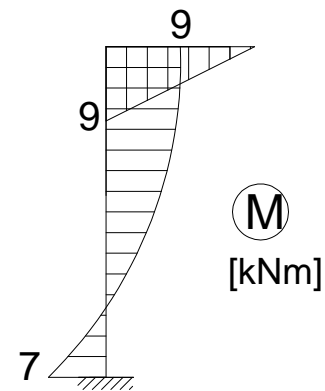

dr inż. Hanna Weber

(B)

(A)

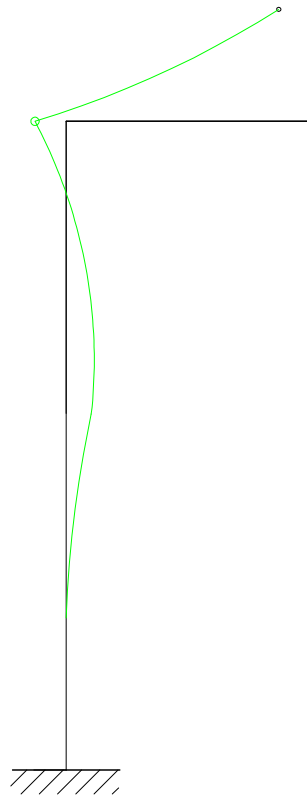

(C)

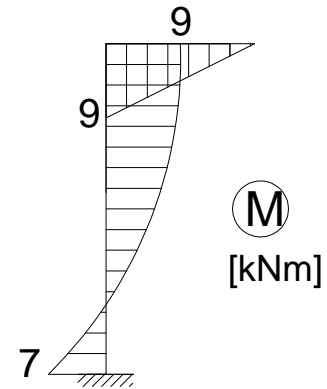

dr inż. Hanna Weber

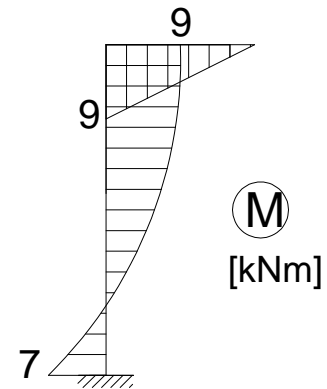
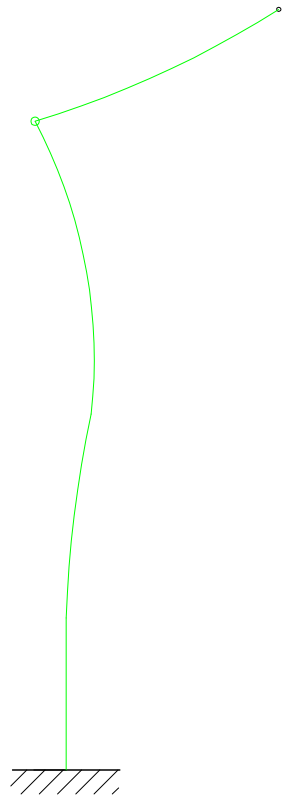

dr inż. Hanna Weber