

# Wykład:

Liczenie przemieszczeń w belkach bezpośrednio z układu równań metody przemieszczeń

*Źródło tablic do metody przemieszczeń użytych w prezentacji:  
Dyląg Z. „Mechanika Budowli”, PWN, Warszawa 1989*

Dobór schematu podstawowego metody przemieszczeń w belkach przy wyznaczaniu wykresu  $M$  w minimalnej ilości niewiadomych:

- Znajdujemy część statycznie wyznaczalną i pozostawiamy ją bez dodatkowych blokad,
- Wszystkie środkowe podpory przegubowe blokujemy na obrót,
- Środkowe przeguby blokujemy na przesunięcie na kierunku prostopadłym do osi belki,
- Sztywnie połączone punkty skokowej zmiany sztywności blokujemy na obrót i na przesunięcie (jeżeli nie ma podpory blokującej przesuw)

**Zadanie 1:** Dobierz schemat podstawowy metody przemieszczeń dla poniższego układu i dokonaj podziału na elementy. Zadanie rozwiąż w minimalnej bazie niewiadomych.

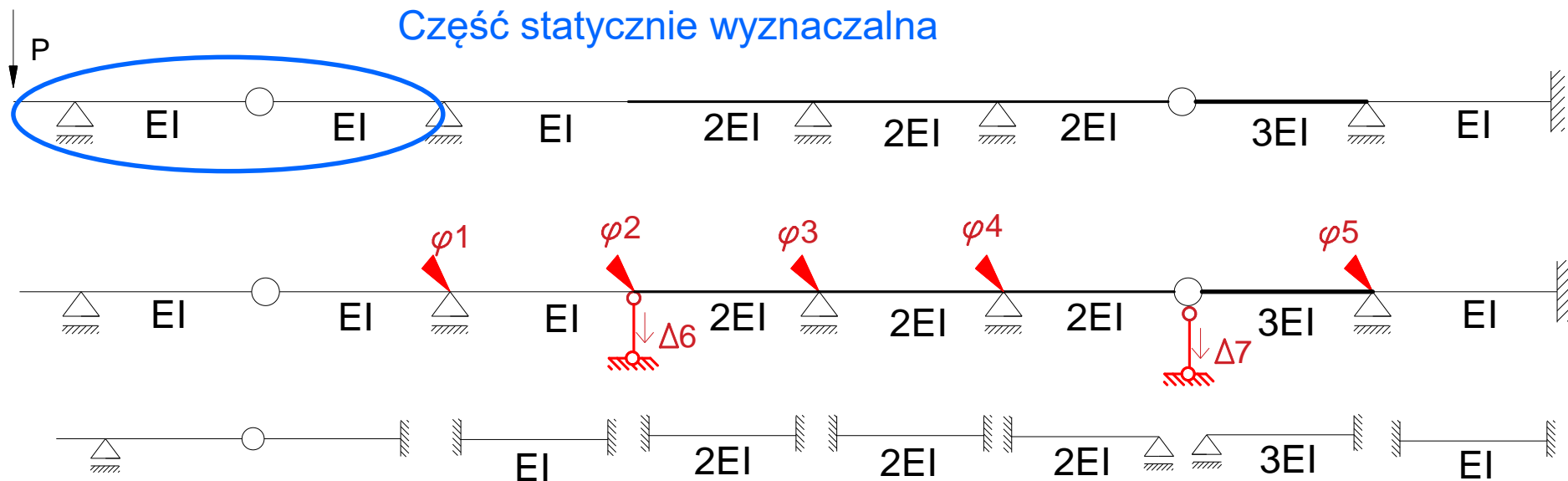

Zadanie 1.: Rozwiązać układ równań metody przemieszczeń dla poniższego układu w minimalnej bazie niewiadomych.

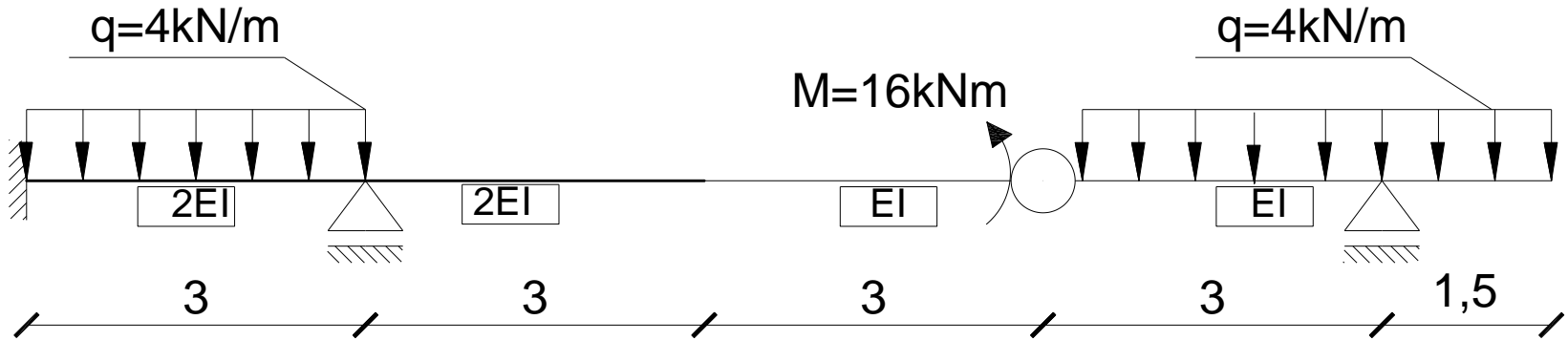

# Schemat podstawowy geometrycznie wyznaczalny

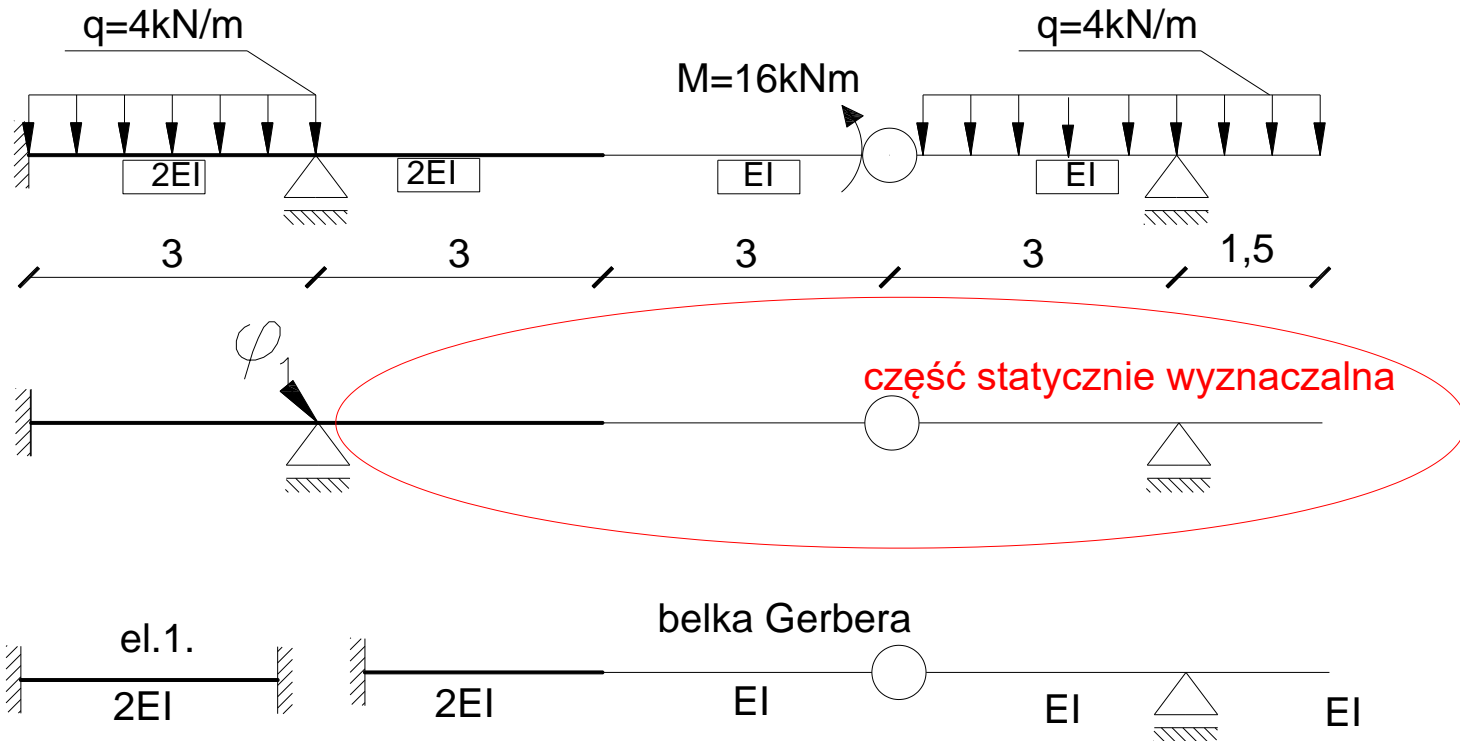

Układ jednokrotnie geometrycznie niewyznaczalny

$$n_g = 1(\varphi_1)$$

Równanie metody przemieszczeń:

$$k_{11} \cdot \varphi_1 + k_{10} = 0$$

# Wykresy jednostkowe i od obciążenia zewnętrznego:

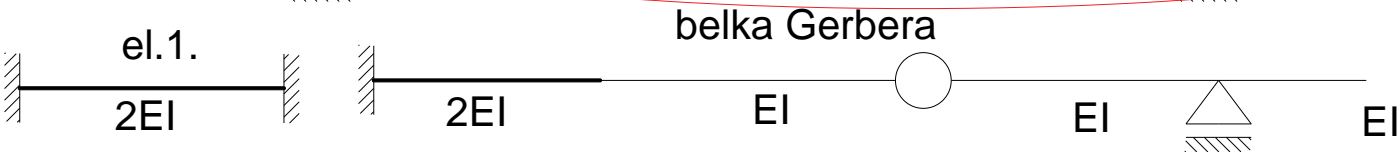
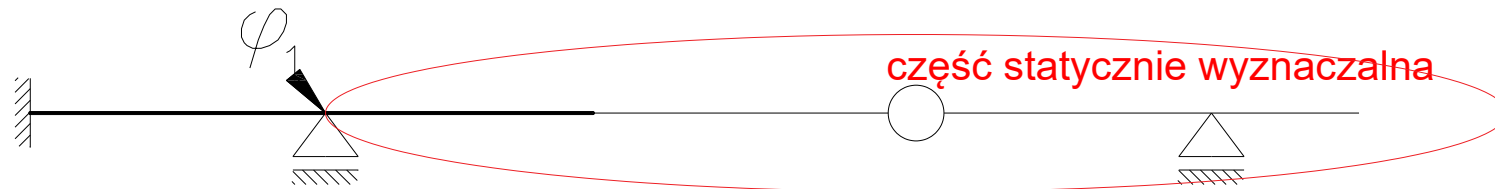
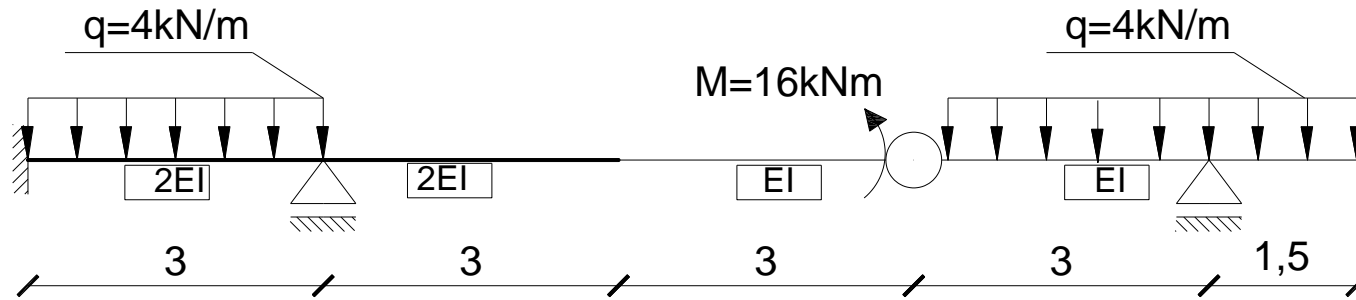

Stan  $\varphi_1 = 1$

# Wykresy jednostkowe i od obciążenia zewnętrznego:

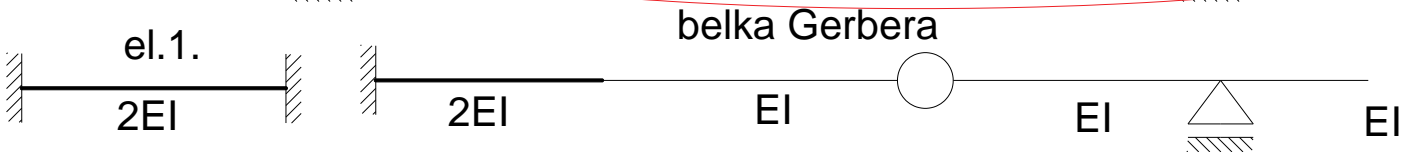
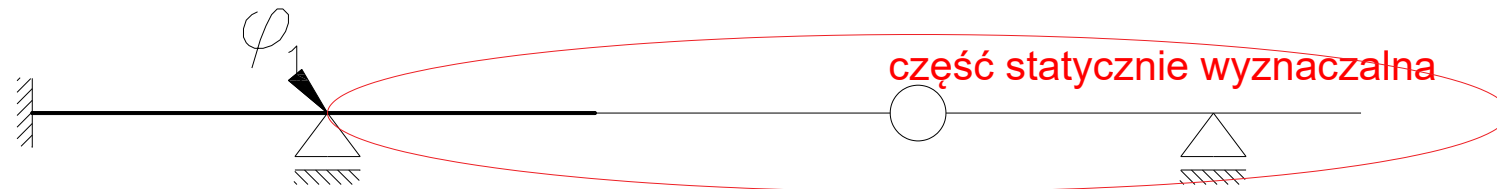
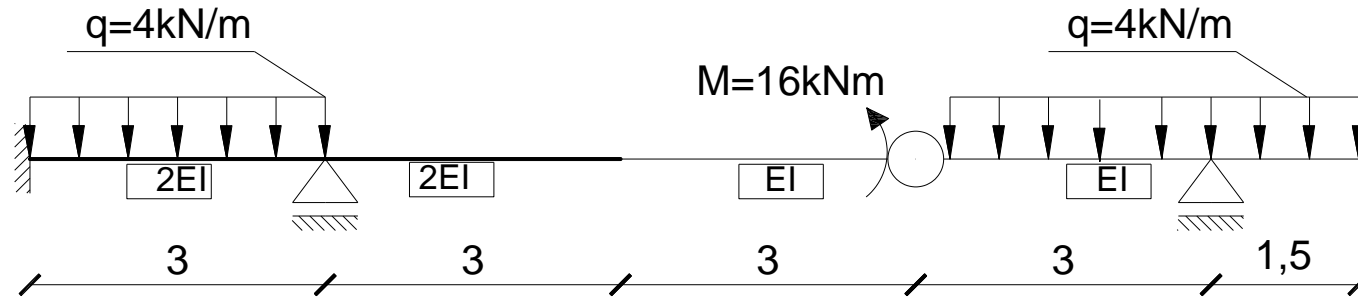

Stan  $\varphi_1=1$

# Wykresy jednostkowe i od obciążenia zewnętrznego:

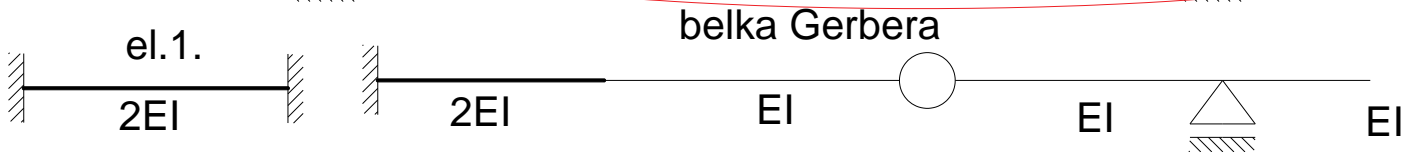
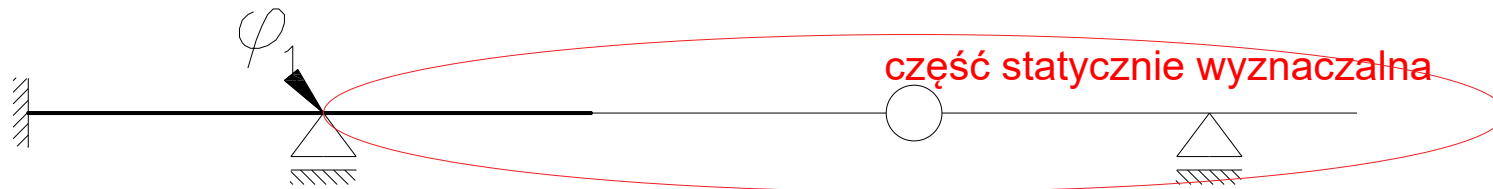
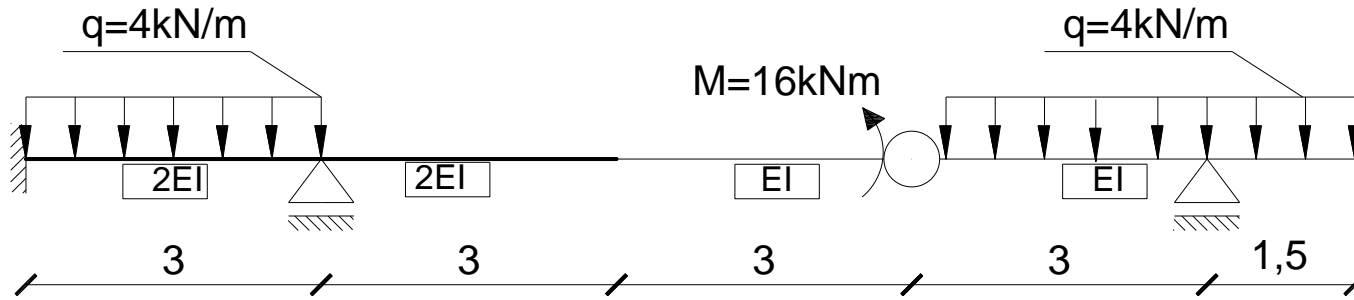

Stan  $\varphi_1=1$



# Wykresy jednostkowe i od obciążenia zewnętrznego:

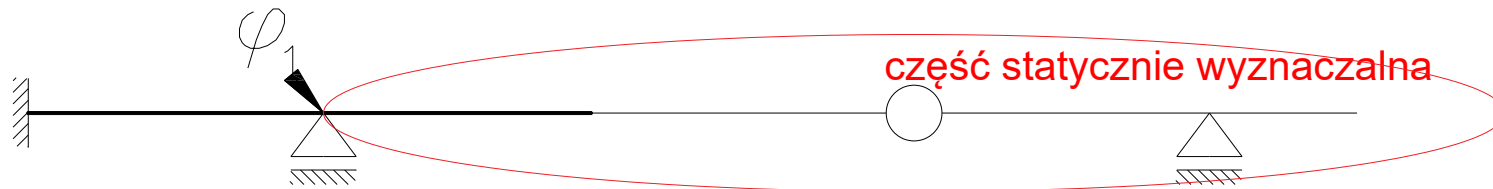
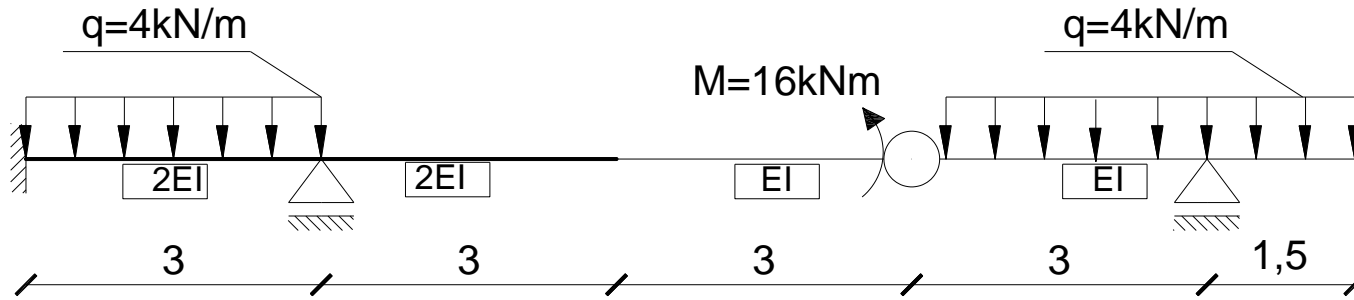

Stan  $\varphi_1 = 1$

# Wykresy jednostkowe i od obciążenia zewnętrznego:

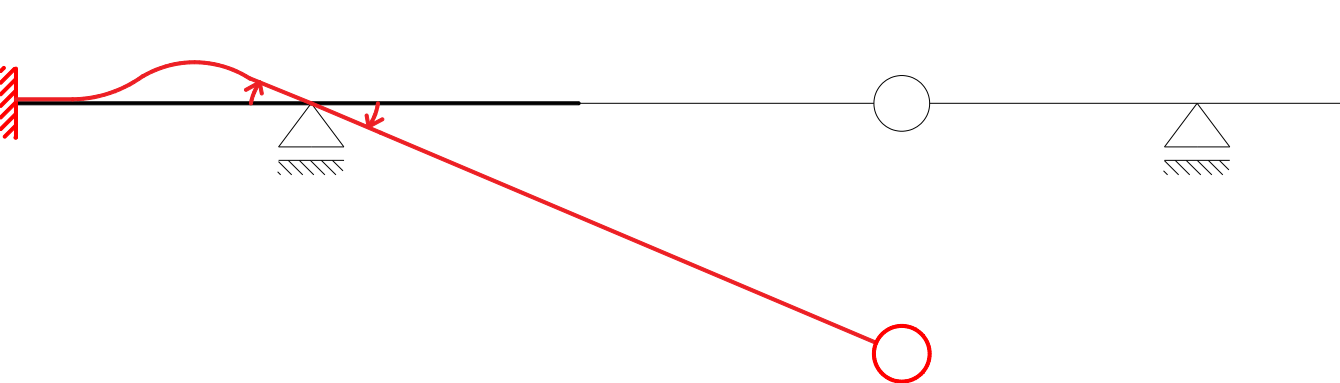
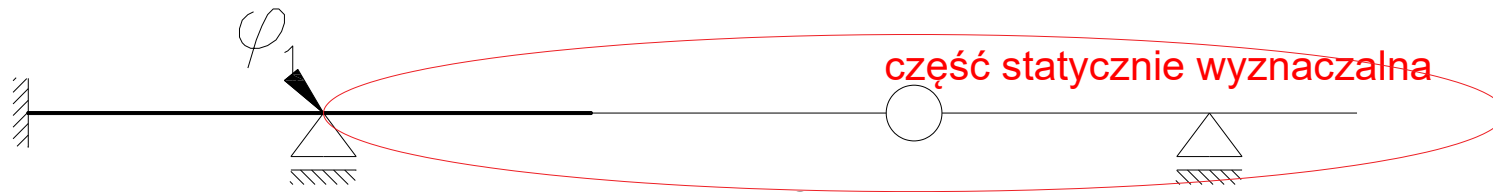
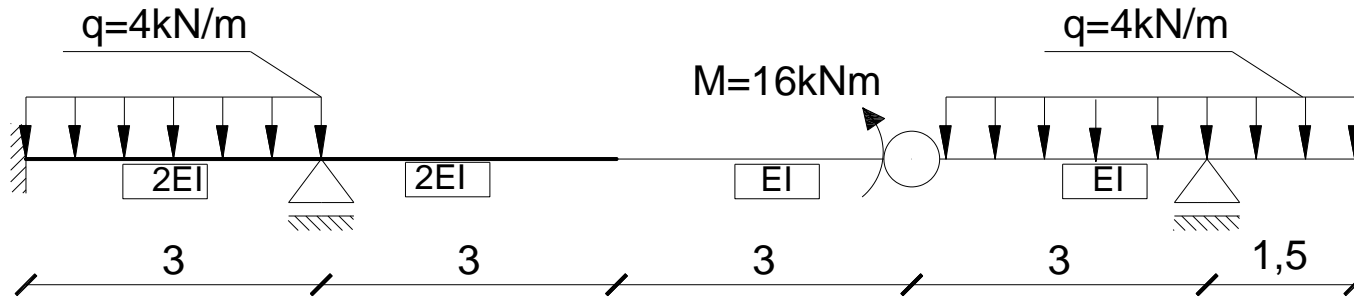

Stan  $\varphi_1=1$

# Wykresy jednostkowe i od obciążenia zewnętrznego:

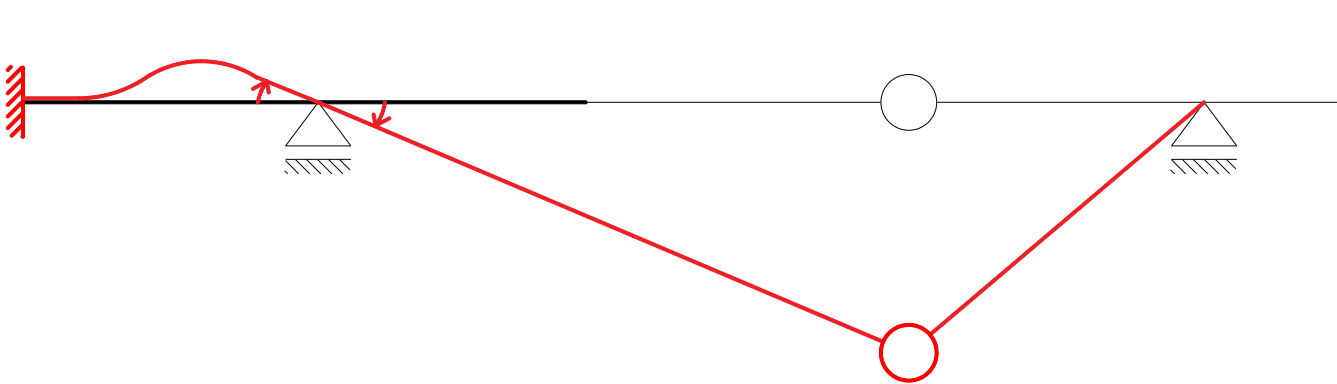
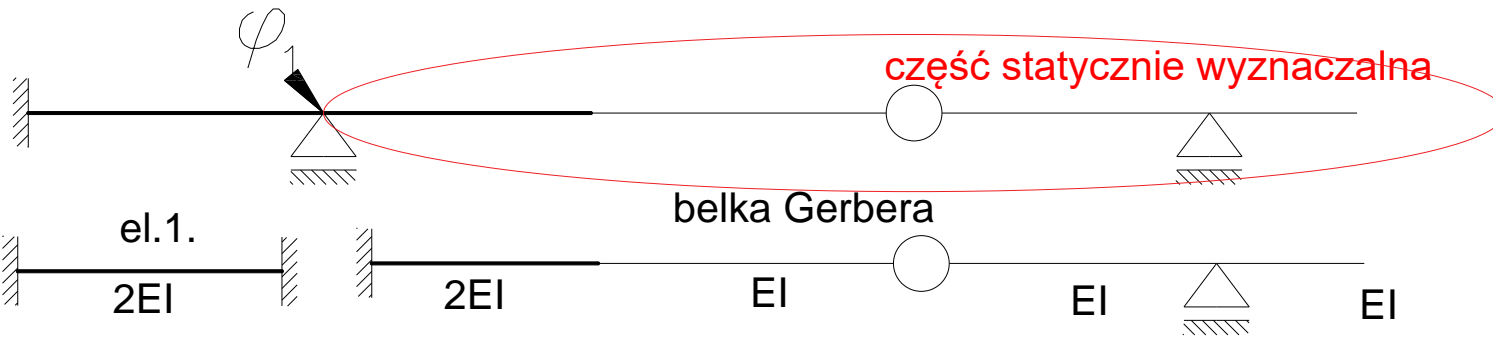
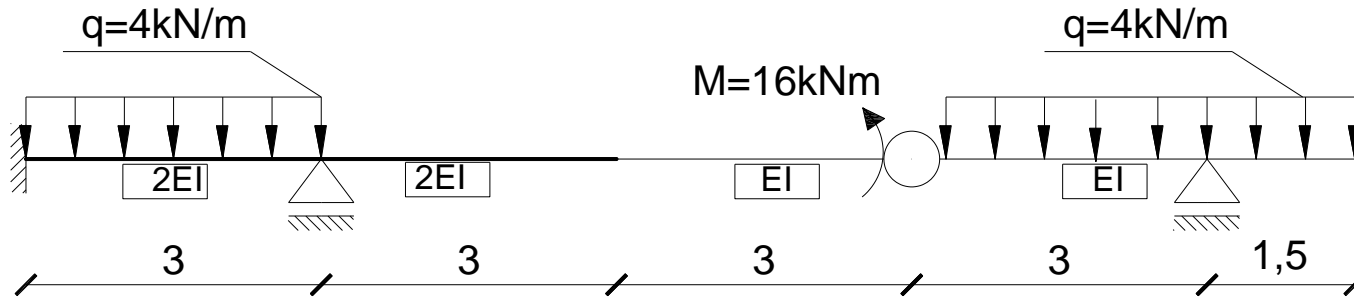

Stan  $\varphi_1=1$

**Wykresy jednostkowe i od obciążenia zewnętrznego:**

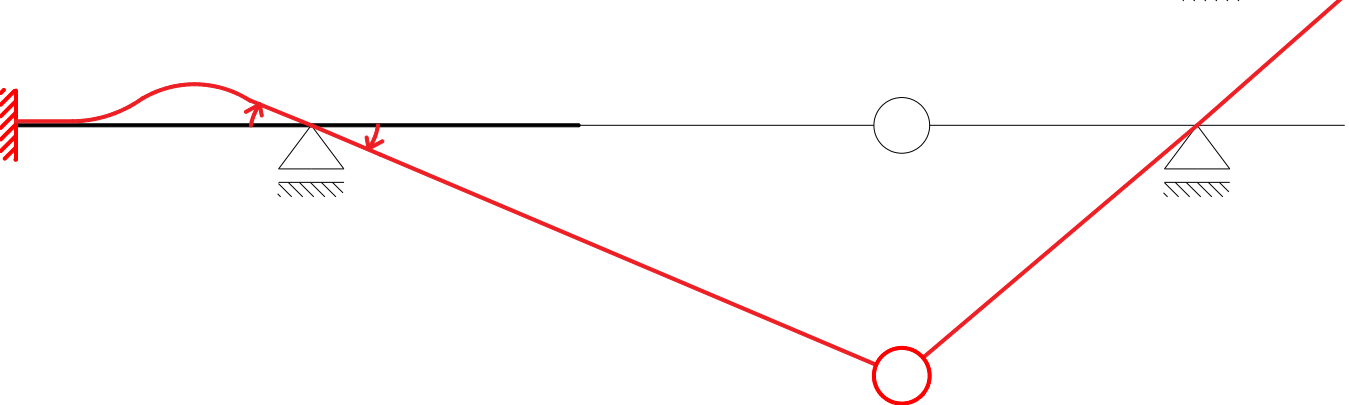
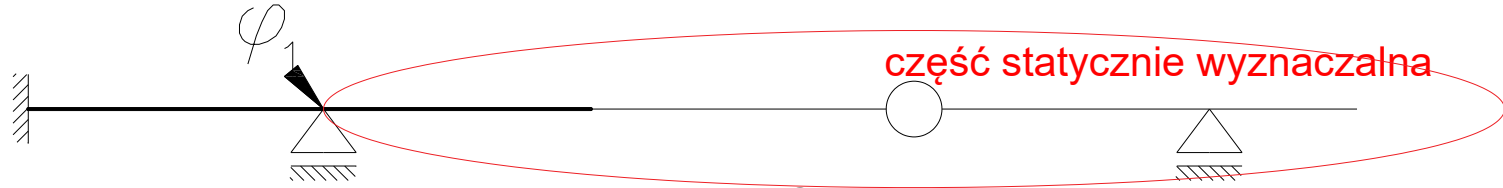
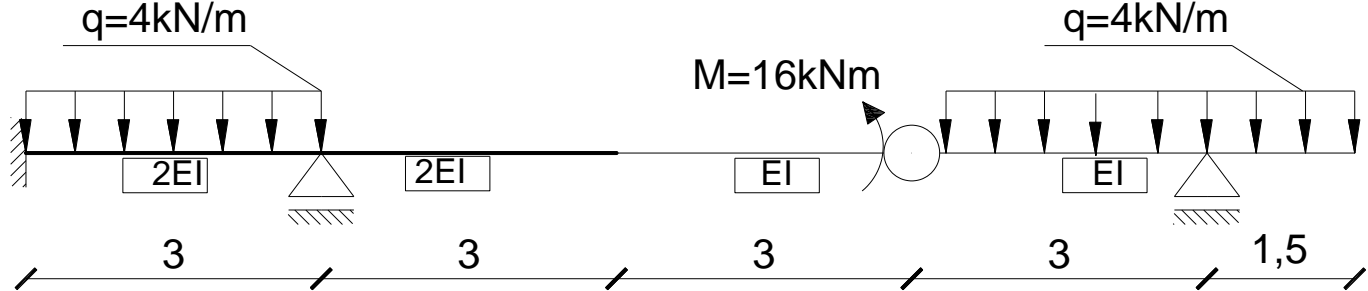

Stan  $\varphi_1=1$

# Wykresy jednostkowe i od obciążenia zewnętrznego:

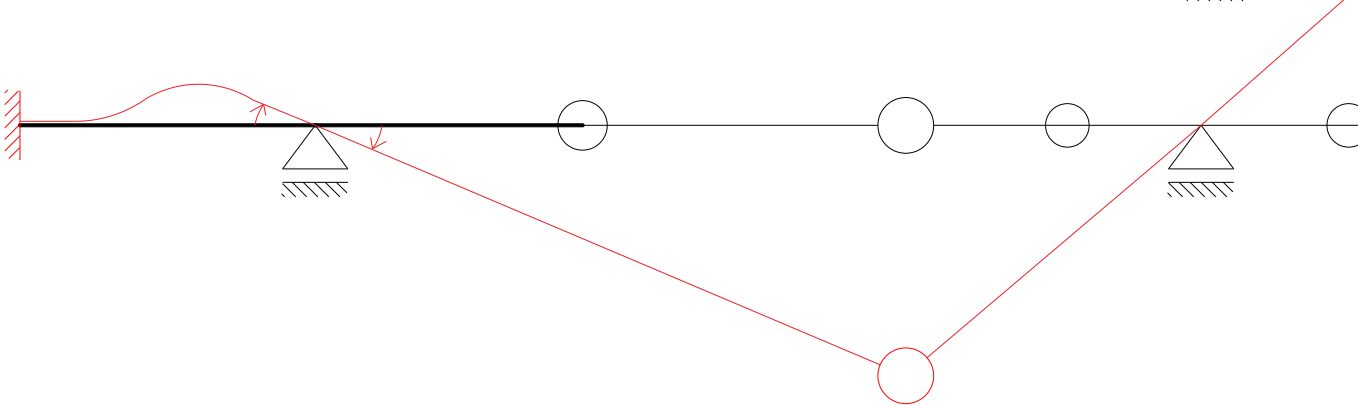
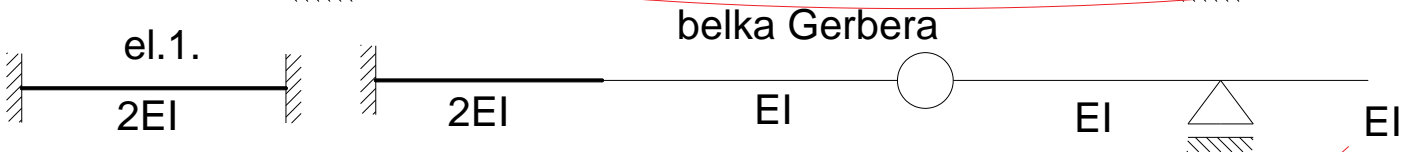
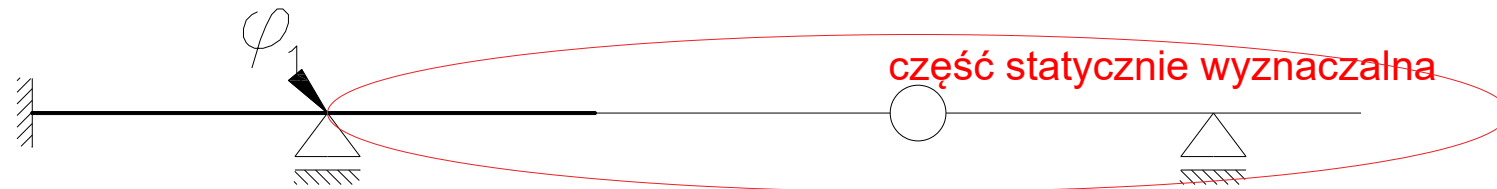
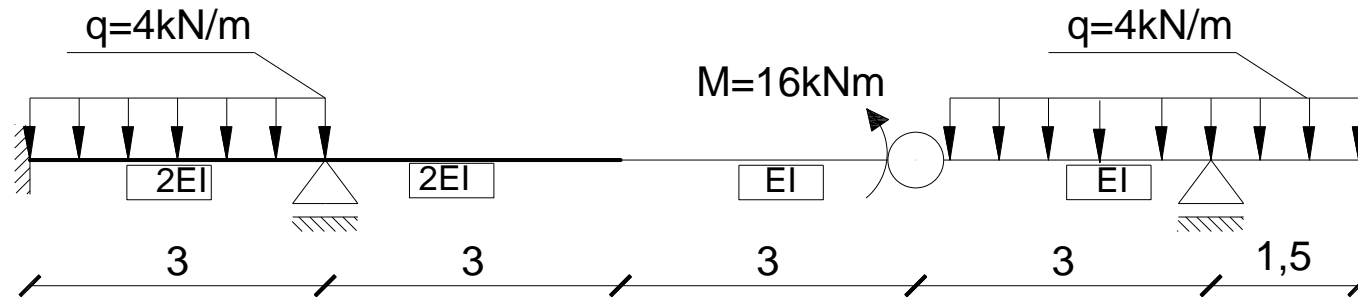

Stan  $\varphi_1=1$

# Wykresy jednostkowe i od obciążenia zewnętrznego:

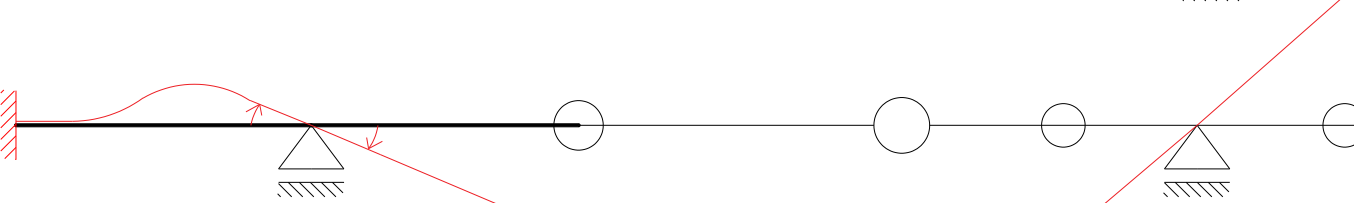
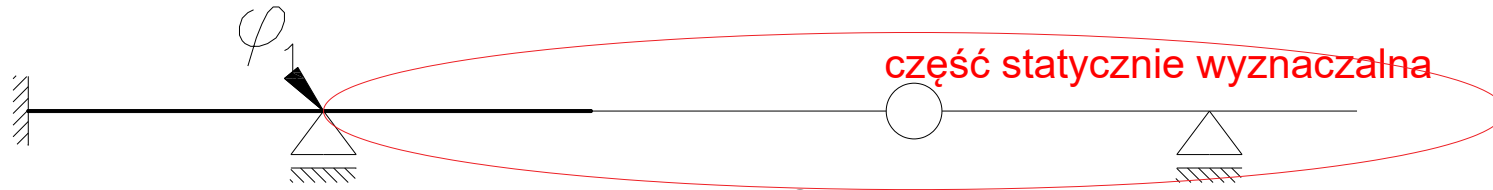
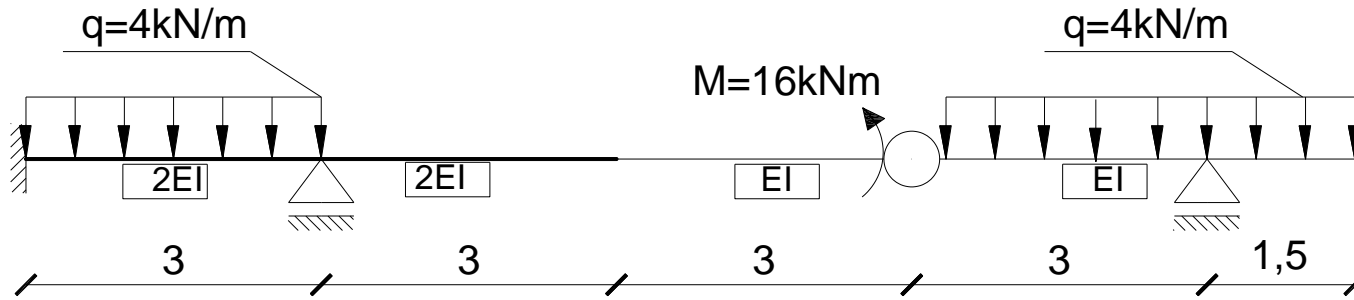

Stan  $\varphi_1=1$

1		$4 \frac{EJ}{l}$	$2 \frac{EJ}{l}$
---	--	------------------	------------------

# Wykresy jednostkowe i od obciążenia zewnętrznego:

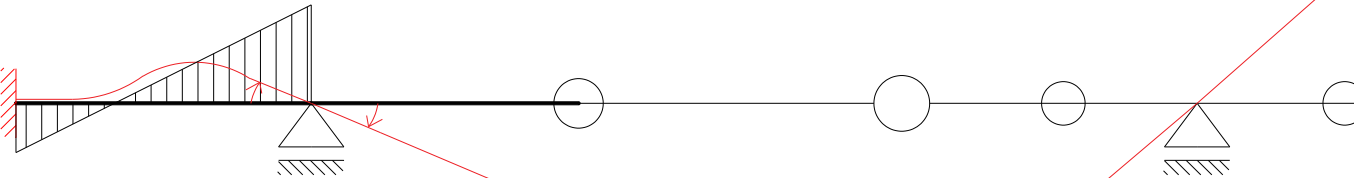
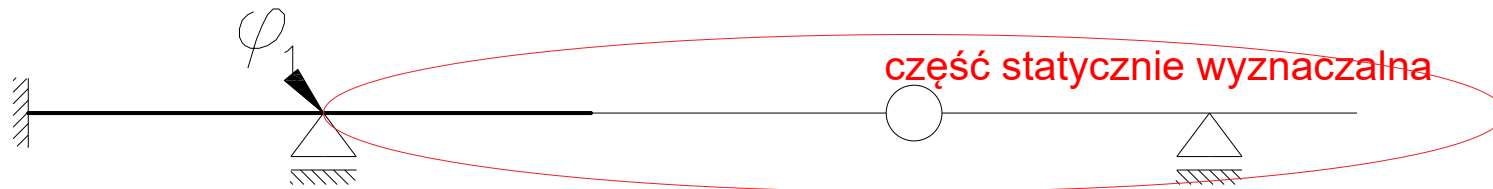
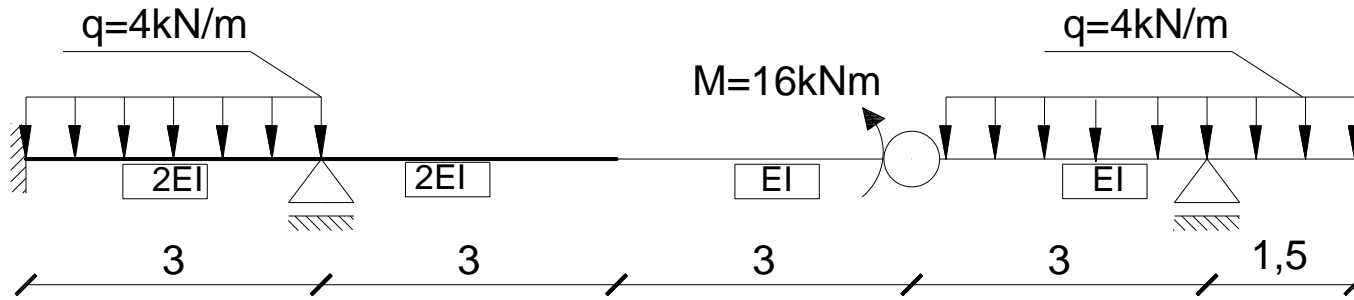

Stan  $\varphi_1=1$

	$4 \frac{EJ}{l}$	$2 \frac{EJ}{l}$
--	------------------	------------------

# Wykresy jednostkowe i od obciążenia zewnętrznego:

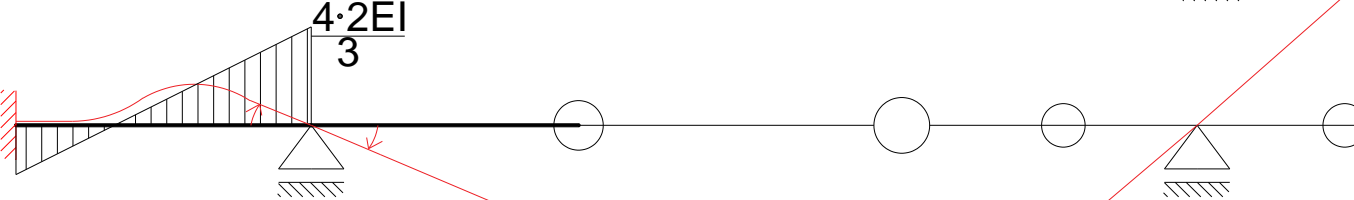
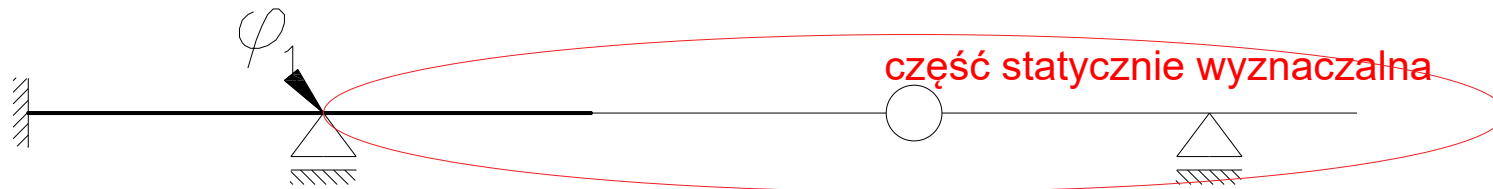
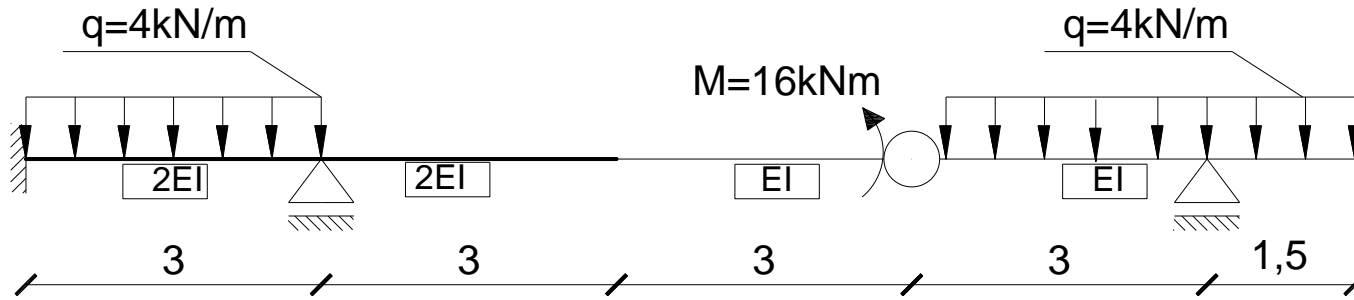

Stan  $\varphi_1=1$

	$4 \frac{EJ}{l}$	$2 \frac{EJ}{l}$
--	------------------	------------------



# Wykresy jednostkowe i od obciążenia zewnętrznego:

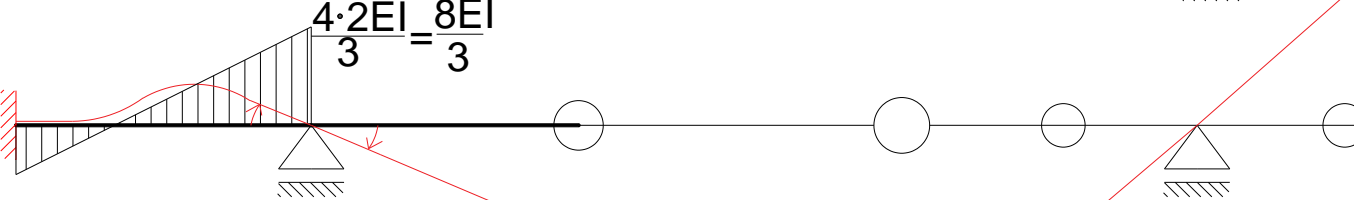
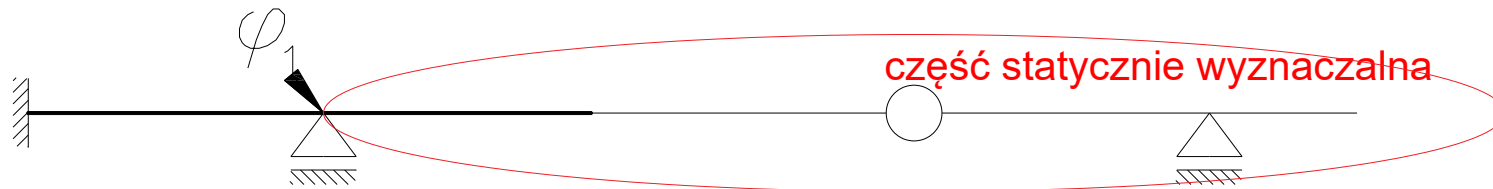
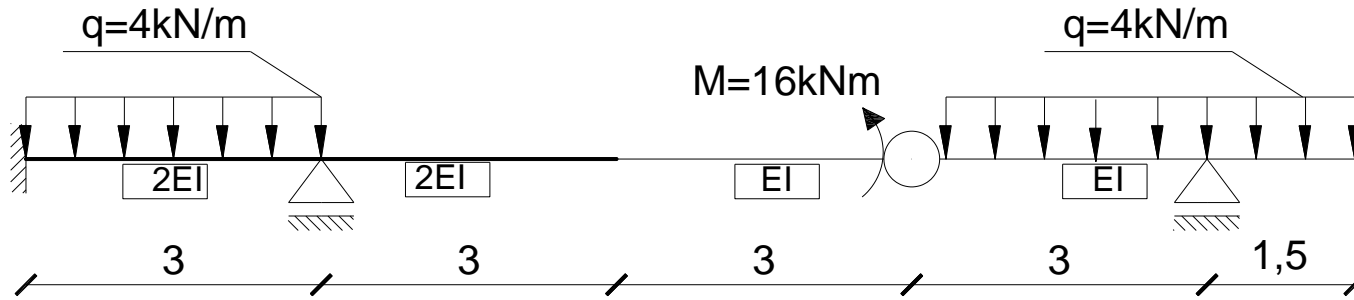

Stan  $\varphi_1=1$

	$4 \frac{EJ}{l}$	$2 \frac{EJ}{l}$
--	------------------	------------------

# Wykresy jednostkowe i od obciążenia zewnętrznego:

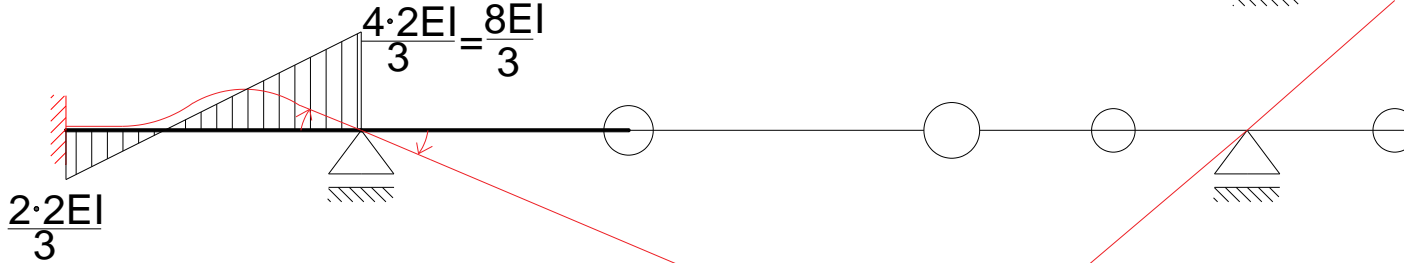
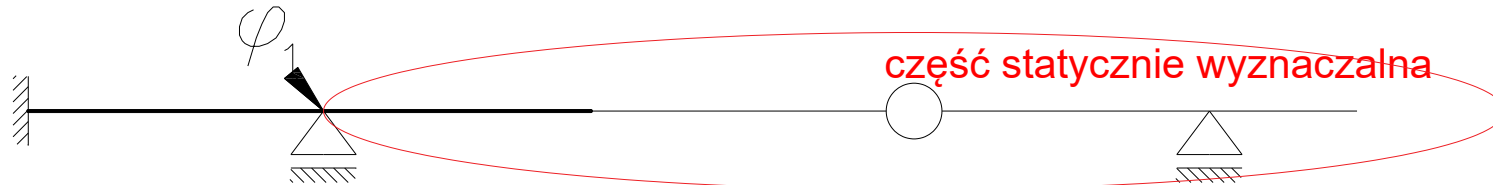
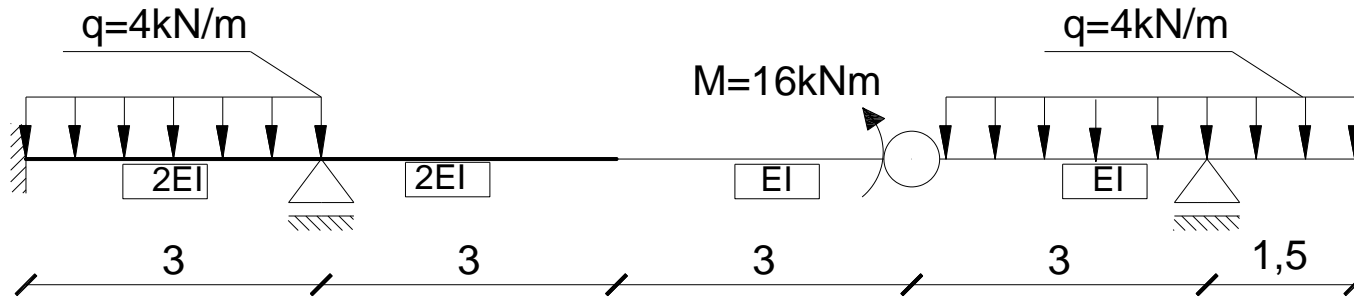

Stan  $\varphi_1=1$

	$4 \frac{EJ}{l}$	$2 \frac{EJ}{l}$
--	------------------	------------------

# Wykresy jednostkowe i od obciążenia zewnętrznego:

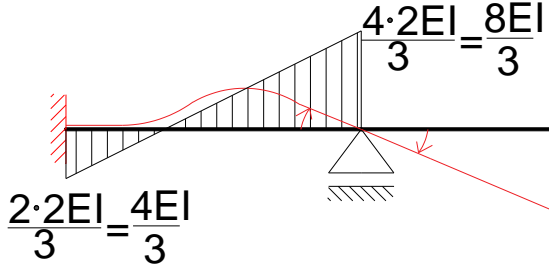
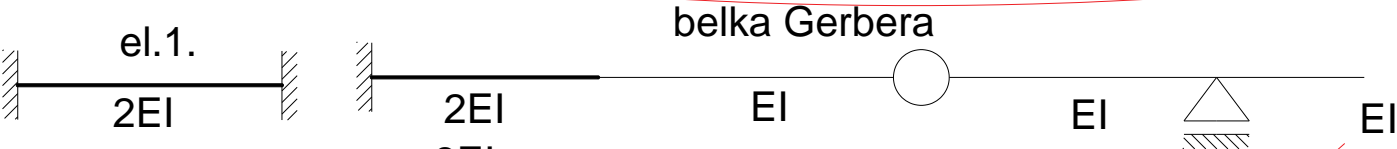
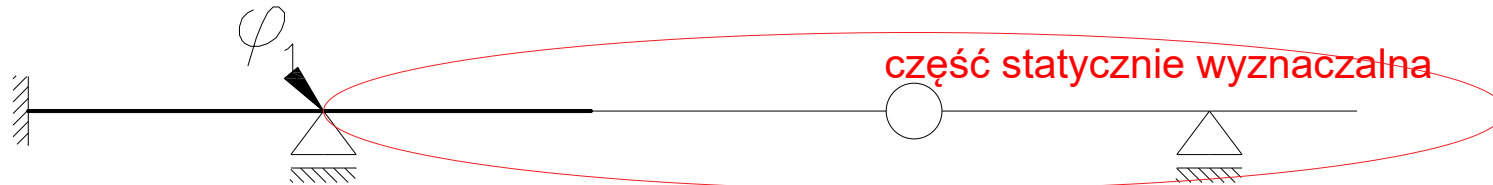
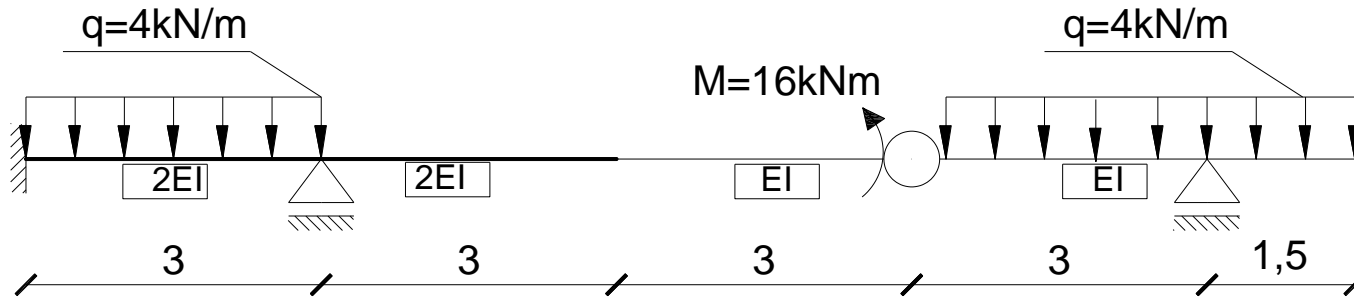

Stan  $\varphi_1=1$

1		$4 \frac{EJ}{l}$	$2 \frac{EJ}{l}$
---	--	------------------	------------------

# Wykresy jednostkowe i od obciążenia zewnętrznego:

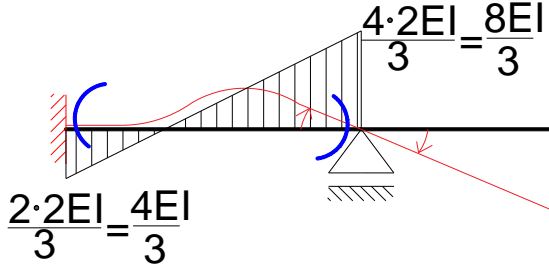
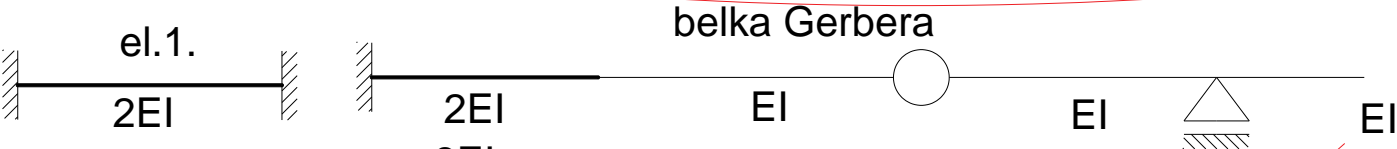
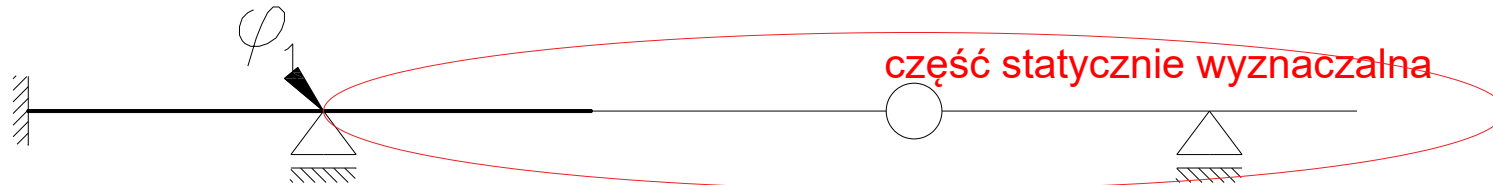
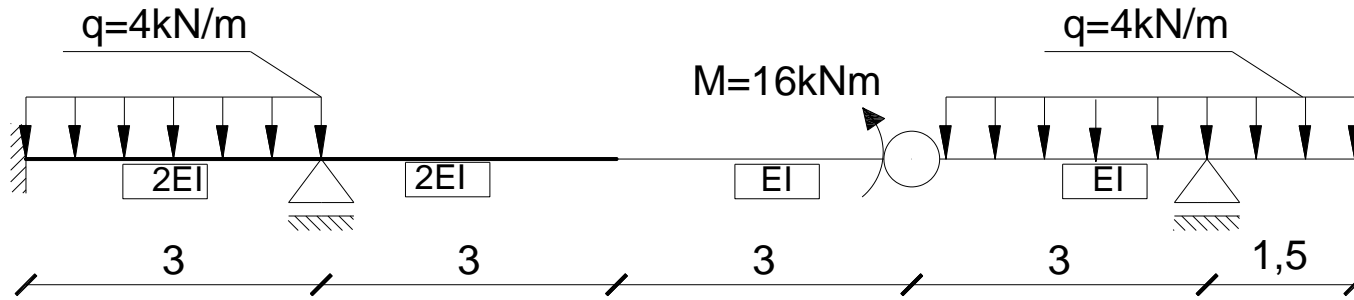

Stan  $\varphi_1=1$

1		$4 \frac{EJ}{l}$	$2 \frac{EJ}{l}$
---	--	------------------	------------------

# Wykresy jednostkowe i od obciążenia zewnętrznego:

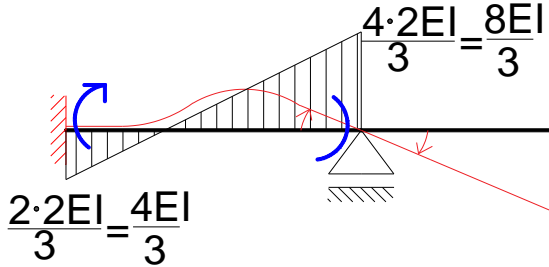
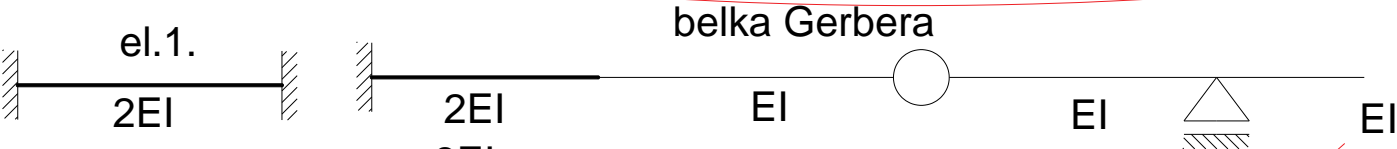
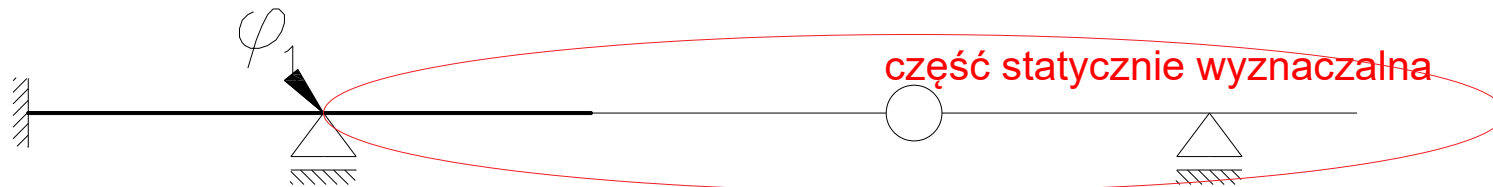
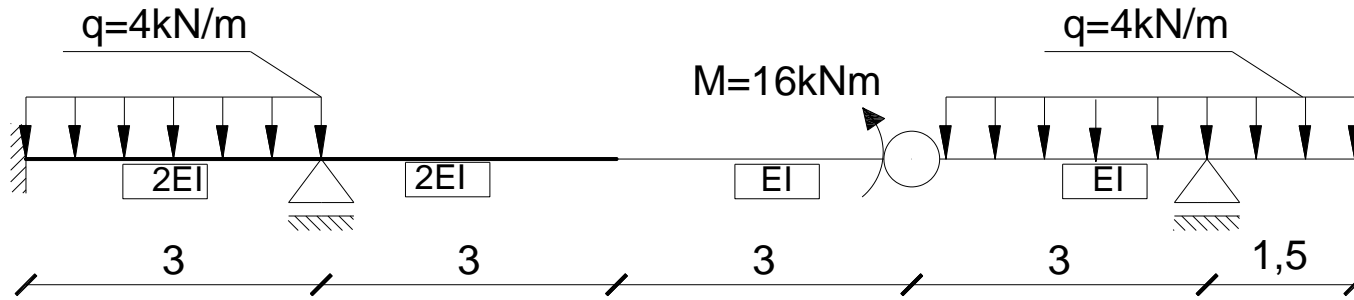

Stan  $\varphi_1=1$

1		$4 \frac{EJ}{l}$	$2 \frac{EJ}{l}$
---	--	------------------	------------------

# Wykresy jednostkowe i od obciążenia zewnętrznego:

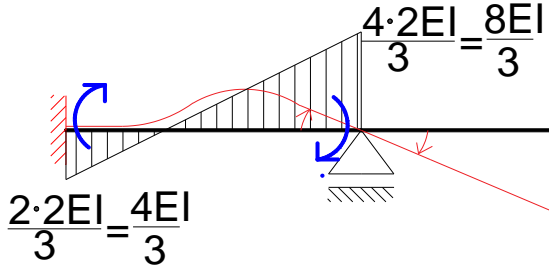
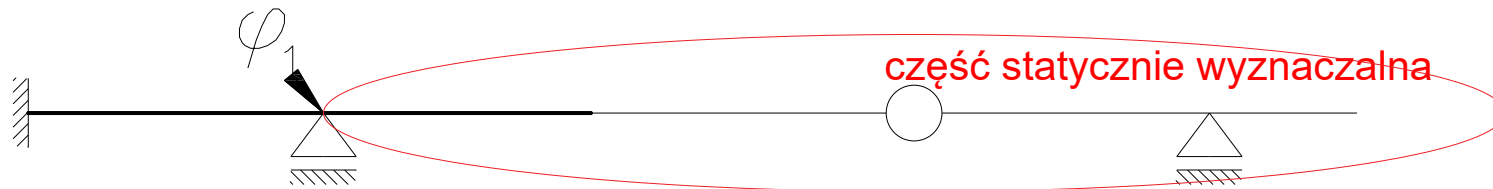
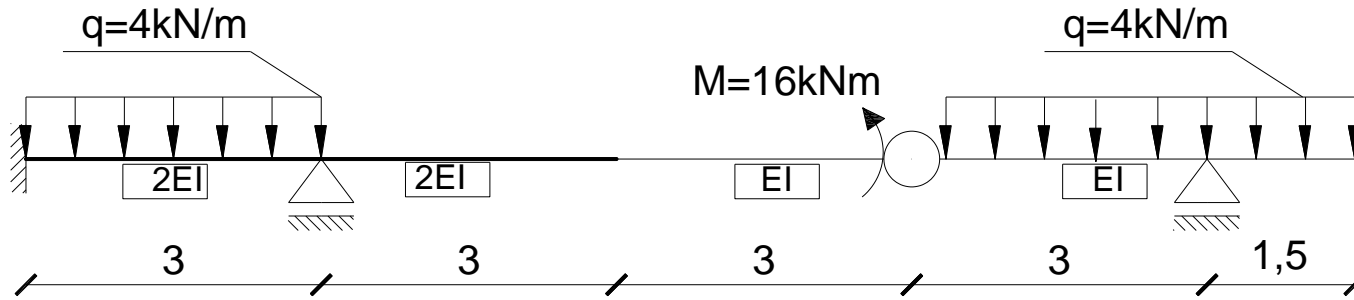

Stan  $\varphi_1=1$

1		$4 \frac{EJ}{l}$	$2 \frac{EJ}{l}$
---	--	------------------	------------------

# Wykresy jednostkowe i od obciążenia zewnętrznego:

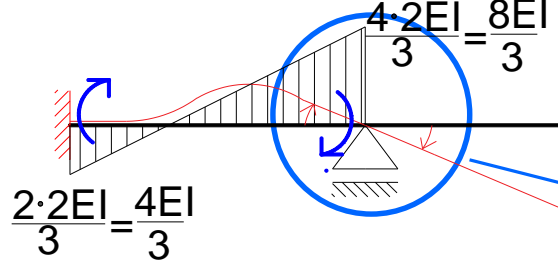
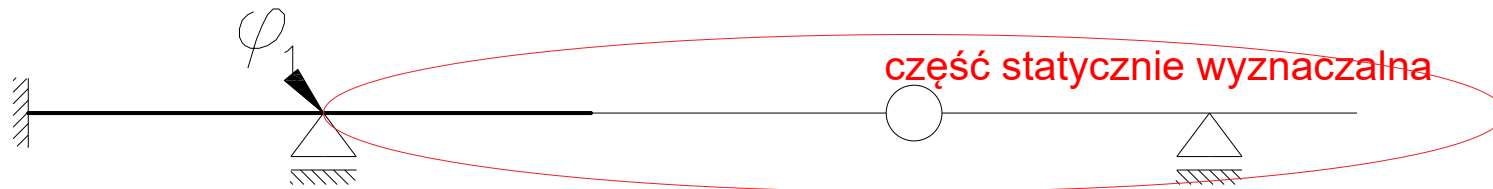
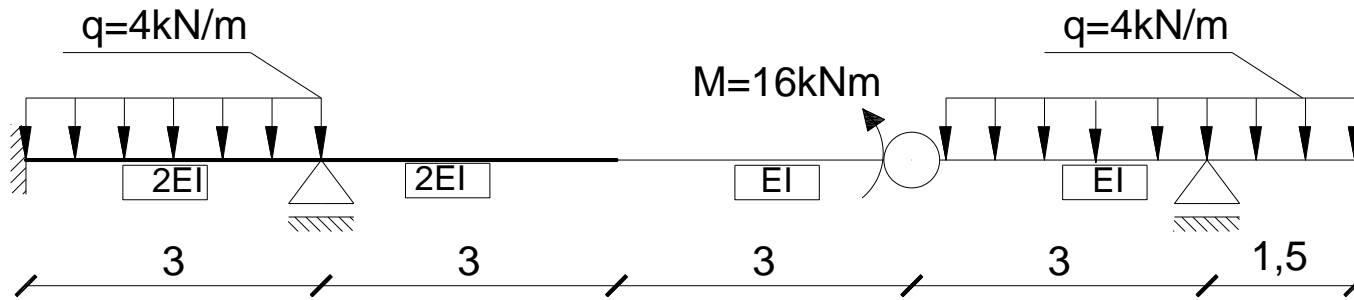

Stan  $\varphi_1=1$

$$k_{11} = \frac{8EI}{3}$$

1		$4 \frac{EJ}{l}$	$2 \frac{EJ}{l}$
---	--	------------------	------------------

# Wykresy jednostkowe i od obciążenia zewnętrznego:

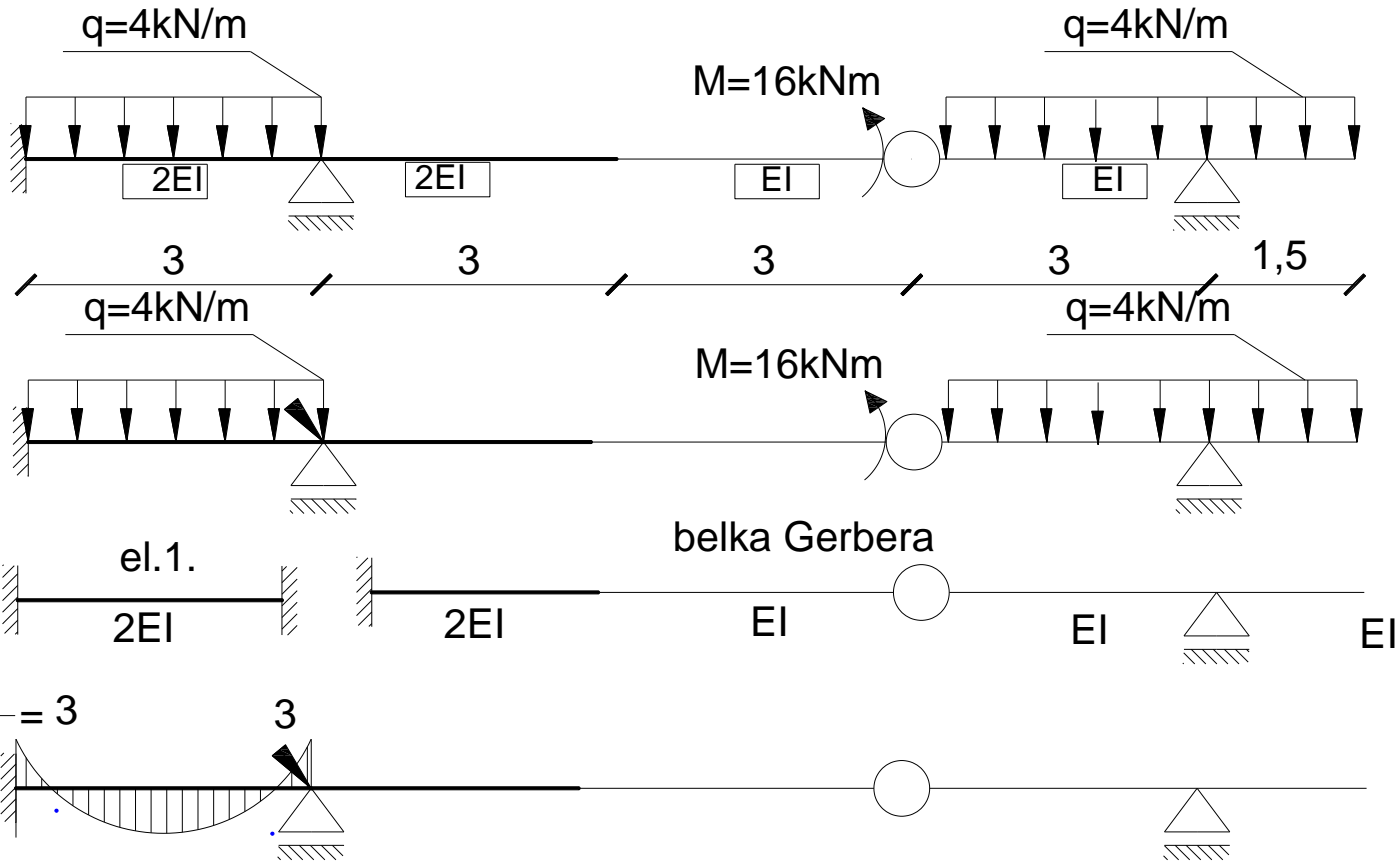

Obciążenie zewnętrzne

6. 6. tablica 17.1.

1	2	3	4
6		$-\frac{ql^2}{12}$	$\frac{ql^2}{12}$



# Wykresy jednostkowe i od obciążenia zewnętrznego:

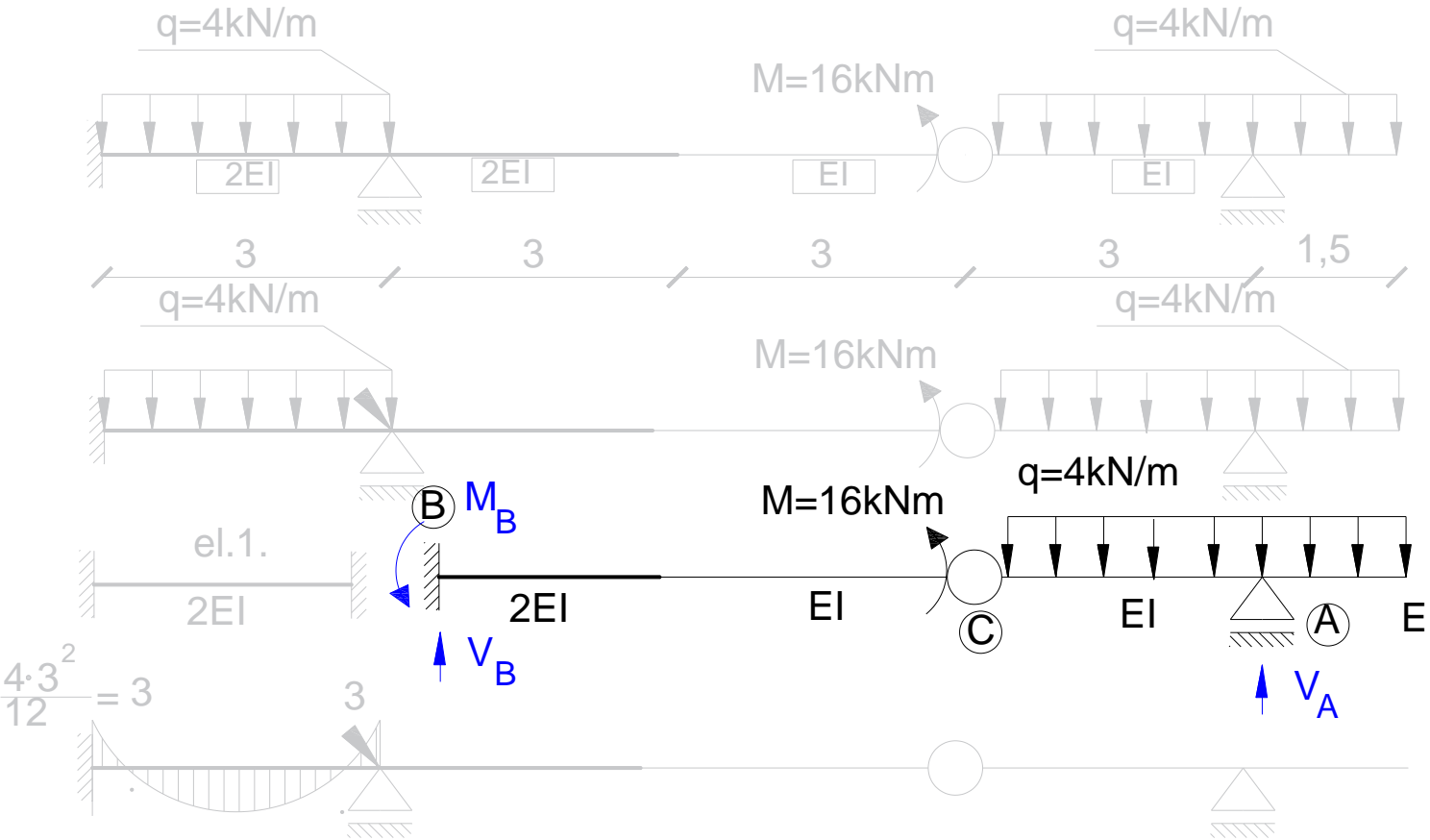

Obciążenie zewnętrzne

# Wykresy jednostkowe i od obciążenia zewnętrznego:

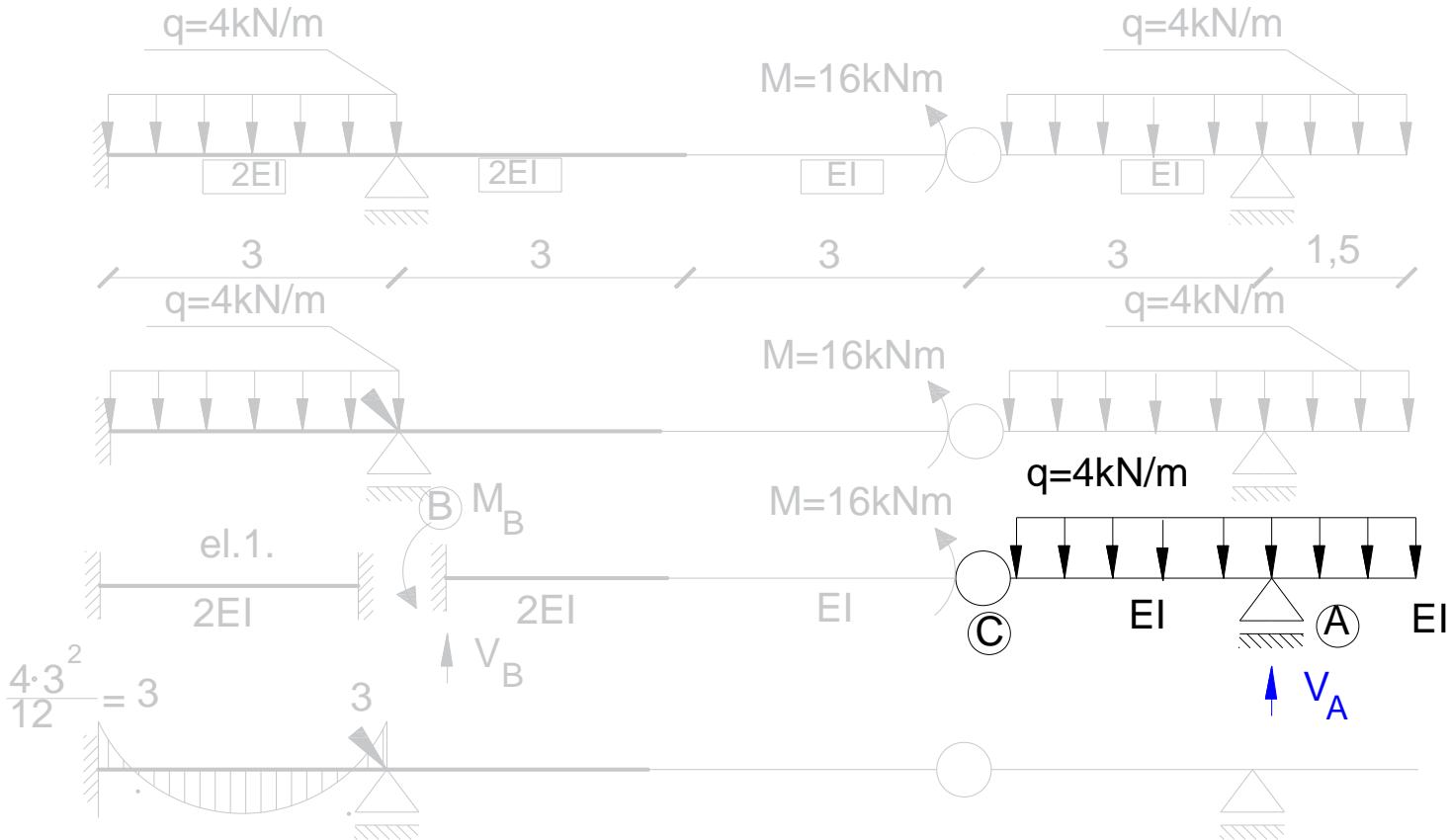

Obciążenie zewnętrzne

$$\sum M_C^P = 4 \cdot 4,5 \cdot \frac{4,5}{2} - V_A \cdot 3 = 0 \rightarrow V_A = 13,5\text{kN}$$

## Wykresy jednostkowe i od obciążenia zewnętrznego:

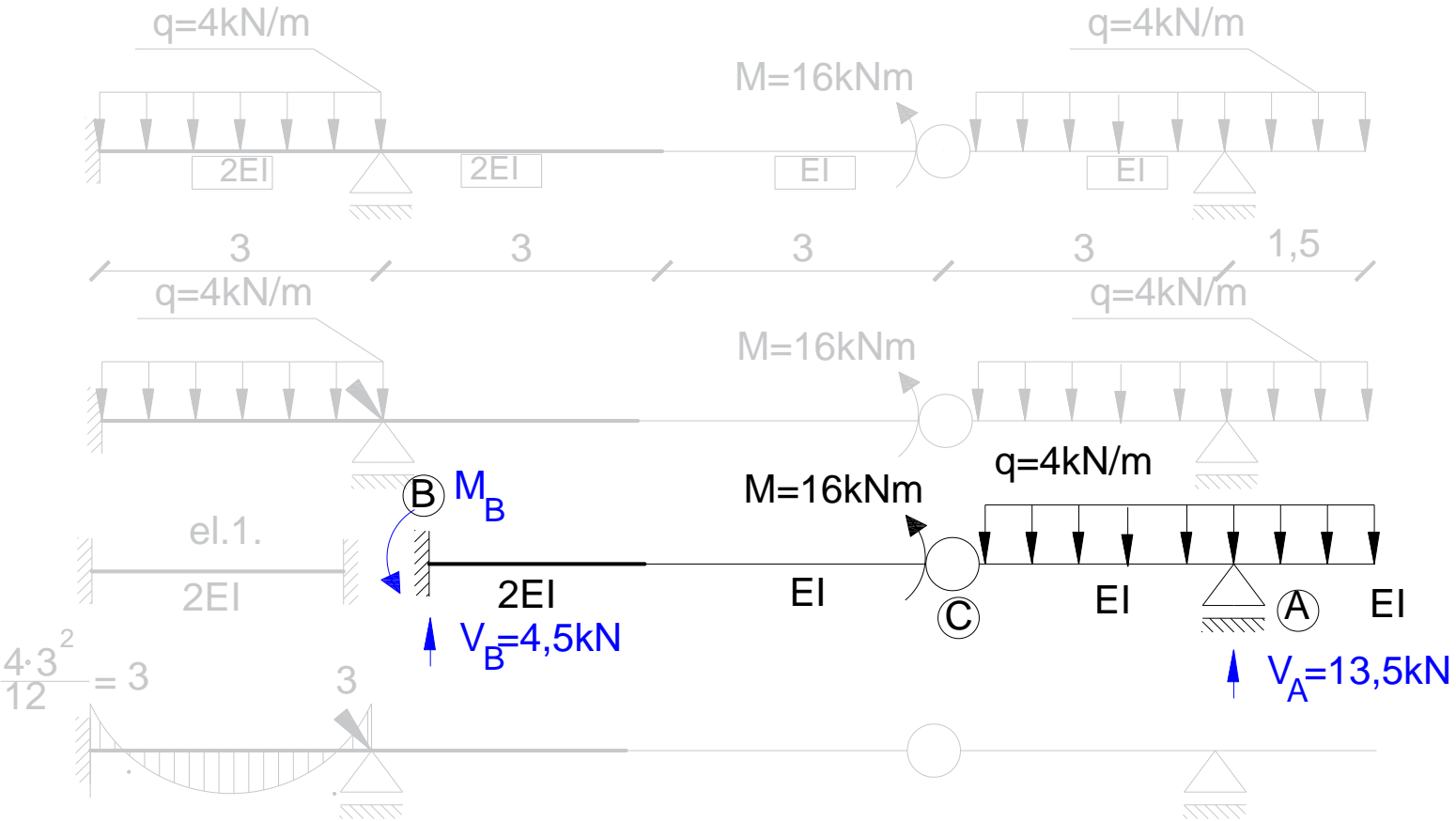

Obciążenie zewnętrzne

$$\sum M_C^P = 4 \cdot 4,5 \cdot \frac{4,5}{2} - V_A \cdot 3 = 0 \rightarrow V_A = 13,5\text{kN}$$

$$\sum R_y = V_B - 4 \cdot 4,5 + 13,5 = 0 \rightarrow V_B = 4,5\text{kN}$$

# Wykresy jednostkowe i od obciążenia zewnętrznego:

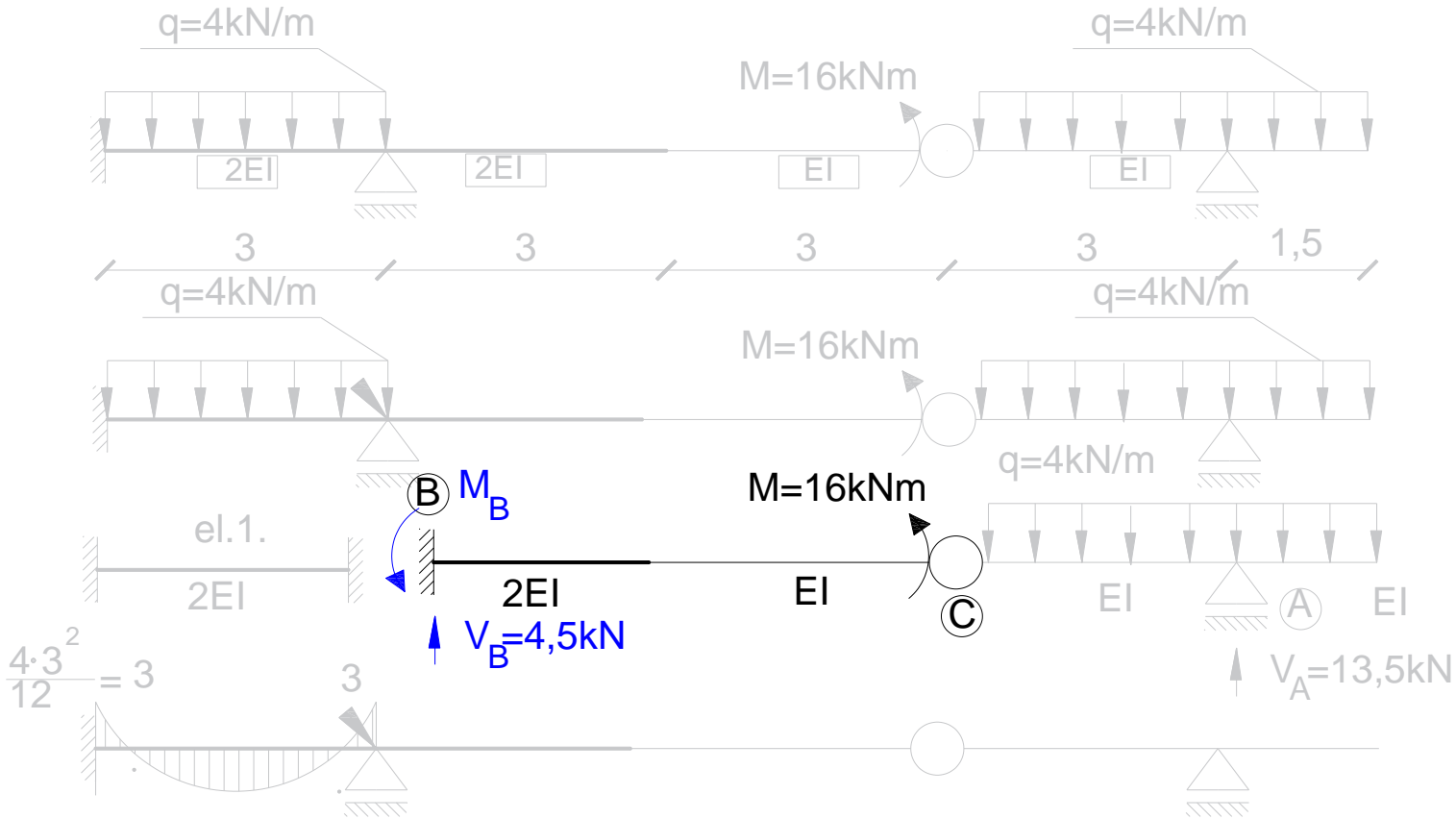

$$\sum M_C^P = 4 \cdot 4,5 \cdot \frac{4,5}{2} - V_A \cdot 3 = 0 \rightarrow V_A = 13,5\text{kN}$$

$$\sum R_y = V_B - 4 \cdot 4,5 + 13,5 = 0 \rightarrow V_B = 4,5\text{kN}$$

$$\sum M_C^L = -M_B - 16 + 4,5 \cdot 6 = 0 \rightarrow M_B = 11\text{kNm}$$

# Wykresy jednostkowe i od obciążenia zewnętrznego:

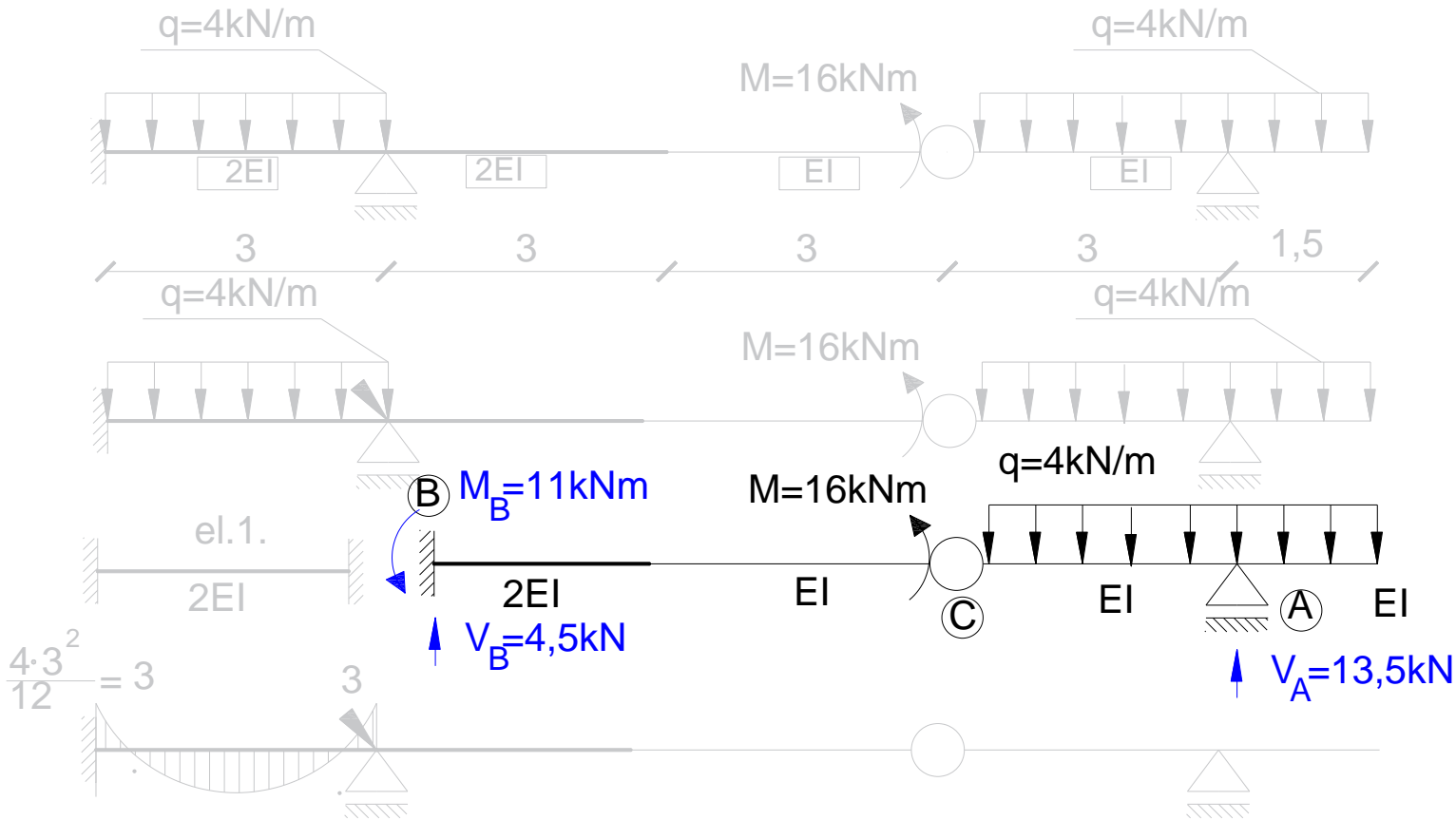

Obciążenie zewnętrzne

$$\sum M_C^P = 4 \cdot 4,5 \cdot \frac{4,5}{2} - V_A \cdot 3 = 0 \rightarrow V_A = 13,5\text{ kN}$$

$$\sum R_y = V_B - 4 \cdot 4,5 + 13,5 = 0 \rightarrow V_B = 4,5\text{ kN}$$

$$\sum M_C^L = -M_B - 16 + 4,5 \cdot 6 = 0 \rightarrow M_B = 11\text{ kNm}$$

## Wykresy jednostkowe i od obciążenia zewnętrznego:

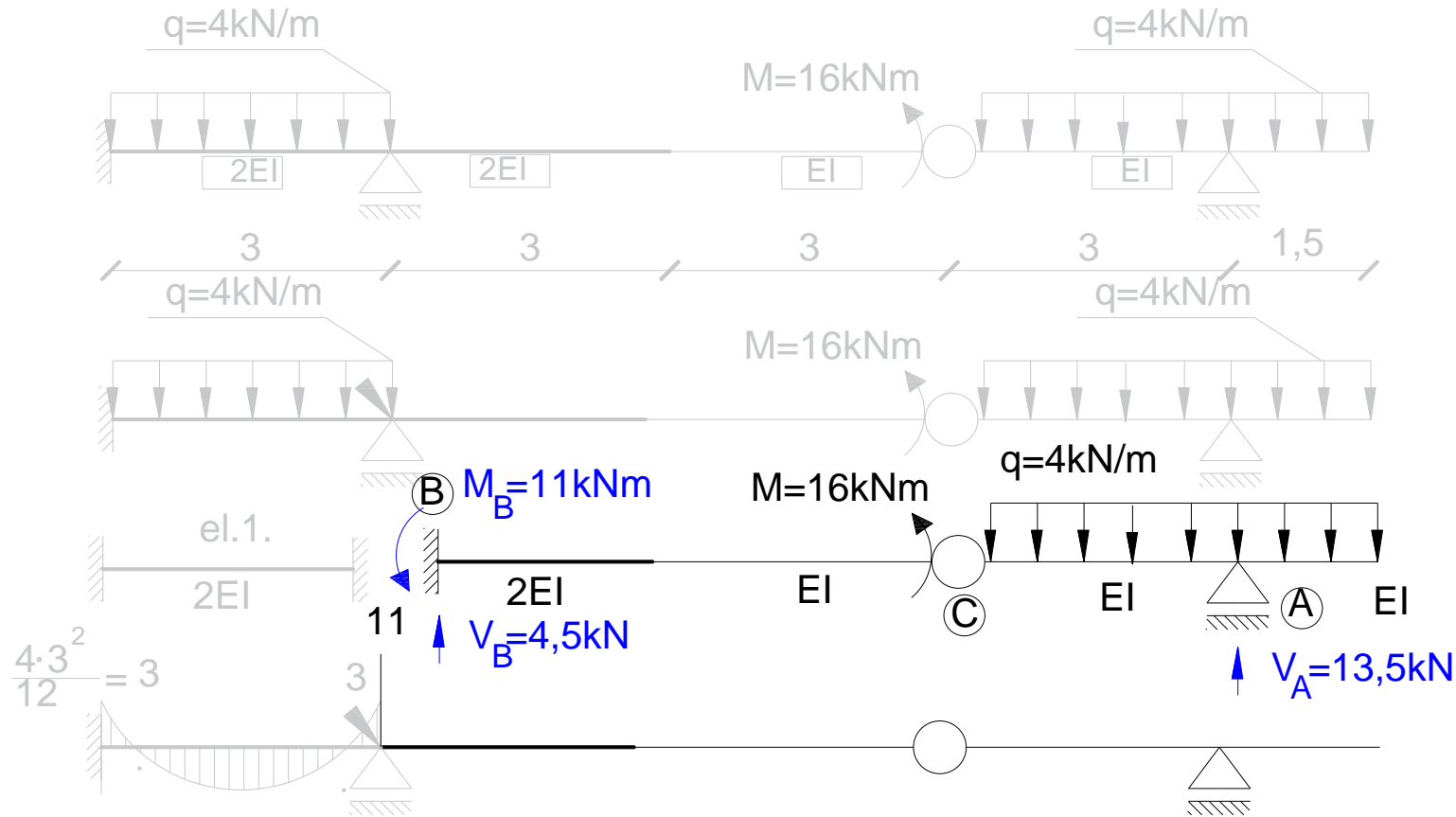

Obciążenie zewnętrzne

$$\sum M_C^P = 4 \cdot 4,5 \cdot \frac{4,5}{2} - V_A \cdot 3 = 0 \rightarrow V_A = 13,5\text{kN}$$

$$\sum R_y = V_B - 4 \cdot 4,5 + 13,5 = 0 \rightarrow V_B = 4,5\text{kN}$$

$$\sum M_C^L = -M_B - 16 + 4,5 \cdot 6 = 0 \rightarrow M_B = 11\text{kNm}$$

# Wykresy jednostkowe i od obciążenia zewnętrznego:

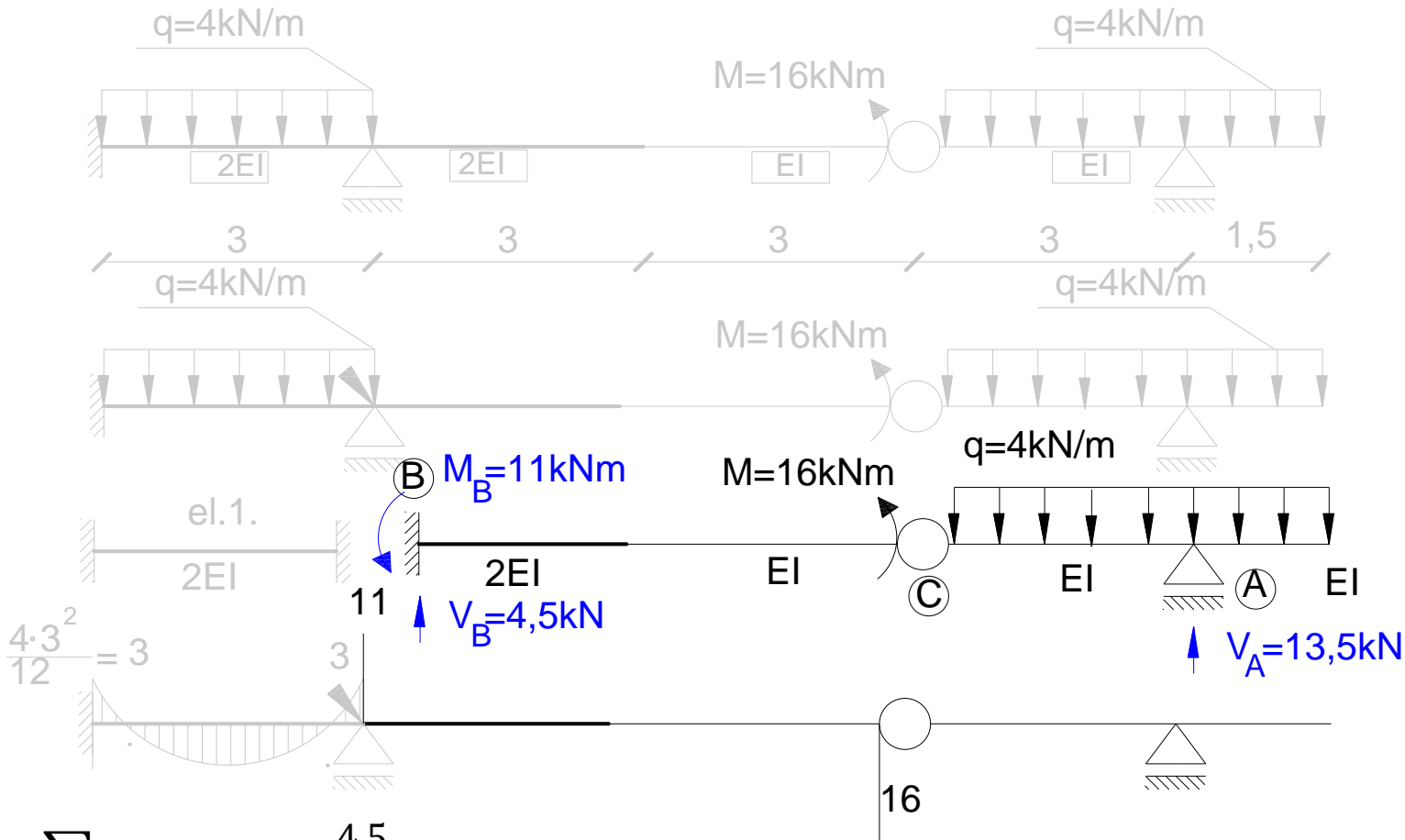

Obciążenie zewnętrzne

$$\sum M_C^P = 4 \cdot 4,5 \cdot \frac{4,5}{2} - V_A \cdot 3 = 0 \rightarrow V_A = 13,5\text{kN}$$

$$\sum R_y = V_B - 4 \cdot 4,5 + 13,5 = 0 \rightarrow V_B = 4,5\text{kN}$$

$$\sum M_C^L = -M_B - 16 + 4,5 \cdot 6 = 0 \rightarrow M_B = 11\text{kNm}$$

# Wykresy jednostkowe i od obciążenia zewnętrznego:

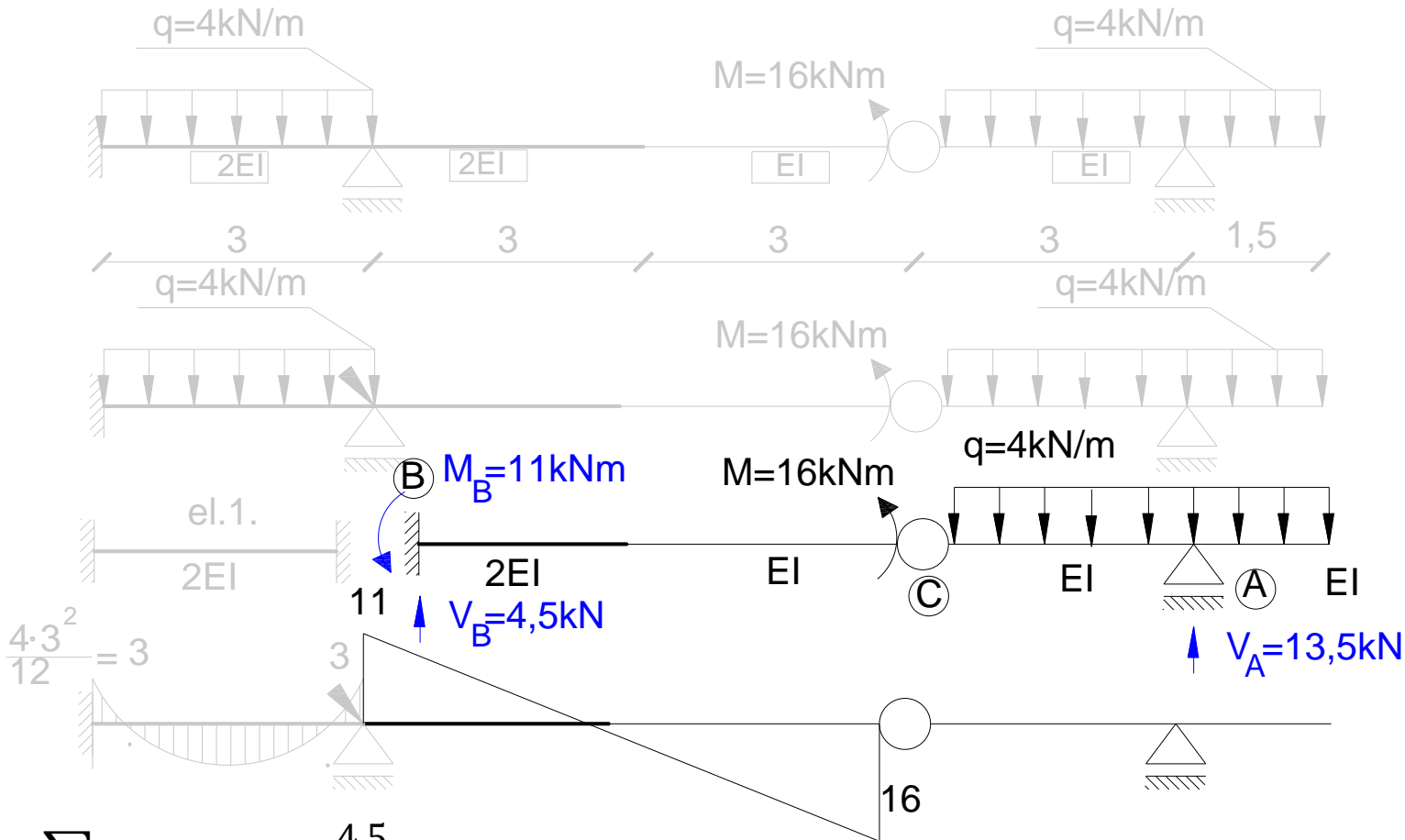

Obciążenie zewnętrzne

$$\sum M_C^P = 4 \cdot 4,5 \cdot \frac{4,5}{2} - V_A \cdot 3 = 0 \rightarrow V_A = 13,5\text{kN}$$

$$\sum R_y = V_B - 4 \cdot 4,5 + 13,5 = 0 \rightarrow V_B = 4,5\text{kN}$$

$$\sum M_C^L = -M_B - 16 + 4,5 \cdot 6 = 0 \rightarrow M_B = 11\text{kNm}$$



# Wykresy jednostkowe i od obciążenia zewnętrznego:

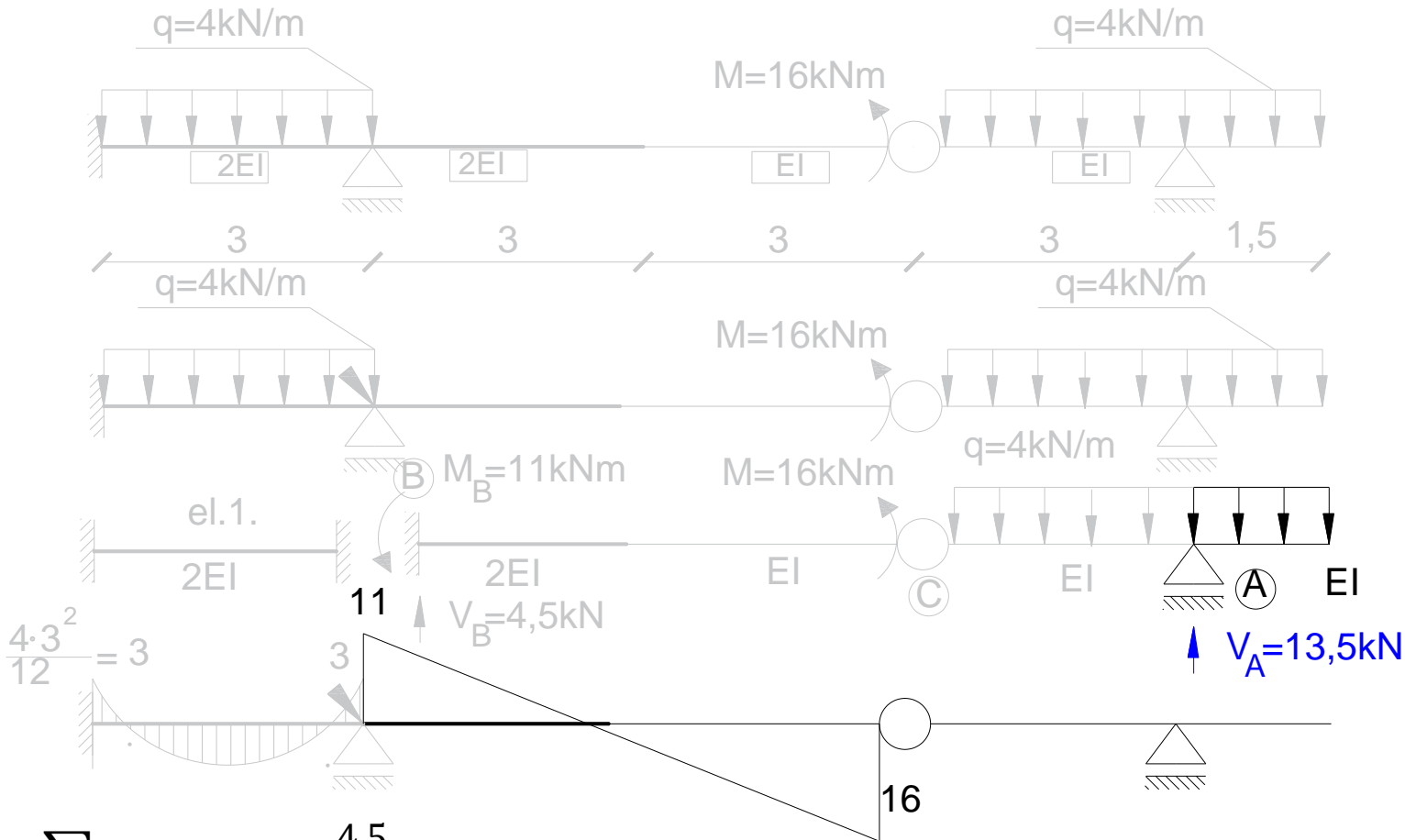

Obciążenie zewnętrzne

$$\sum M_C^P = 4 \cdot 4,5 \cdot \frac{4,5}{2} - V_A \cdot 3 = 0 \rightarrow V_A = 13,5\text{ kN}$$

$$\sum R_y = V_B - 4 \cdot 4,5 + 13,5 = 0 \rightarrow V_B = 4,5\text{ kN}$$

$$\sum M_C^L = -M_B - 16 + 4,5 \cdot 6 = 0 \rightarrow M_B = 11\text{ kNm}$$

# Wykresy jednostkowe i od obciążenia zewnętrznego:

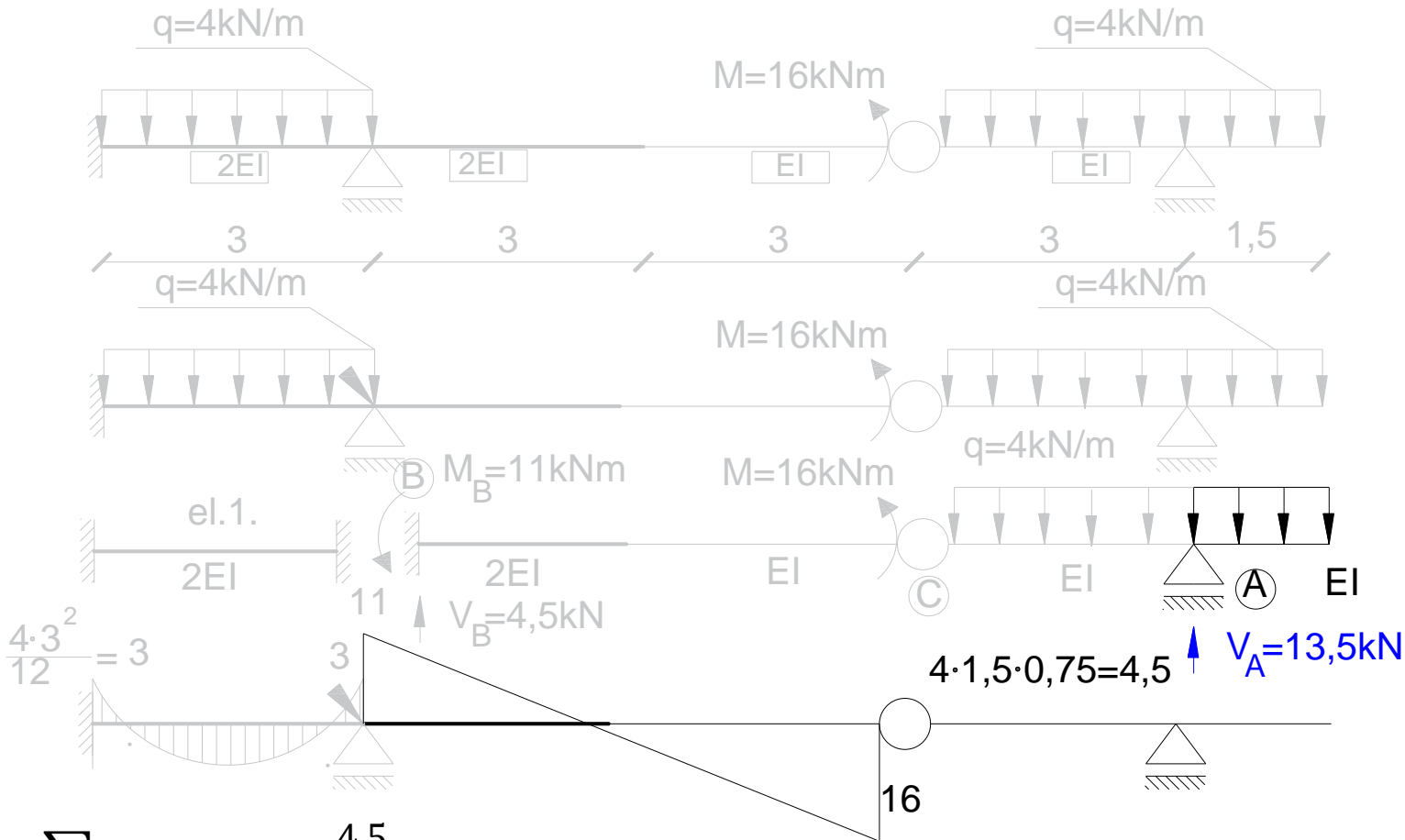

Obciążenie zewnętrzne

$$\sum M_C^P = 4 \cdot 4,5 \cdot \frac{4,5}{2} - V_A \cdot 3 = 0 \rightarrow V_A = 13,5\text{ kN}$$

$$\sum R_y = V_B - 4 \cdot 4,5 + 13,5 = 0 \rightarrow V_B = 4,5\text{ kN}$$

$$\sum M_C^L = -M_B - 16 + 4,5 \cdot 6 = 0 \rightarrow M_B = 11\text{ kNm}$$

# Wykresy jednostkowe i od obciążenia zewnętrznego:

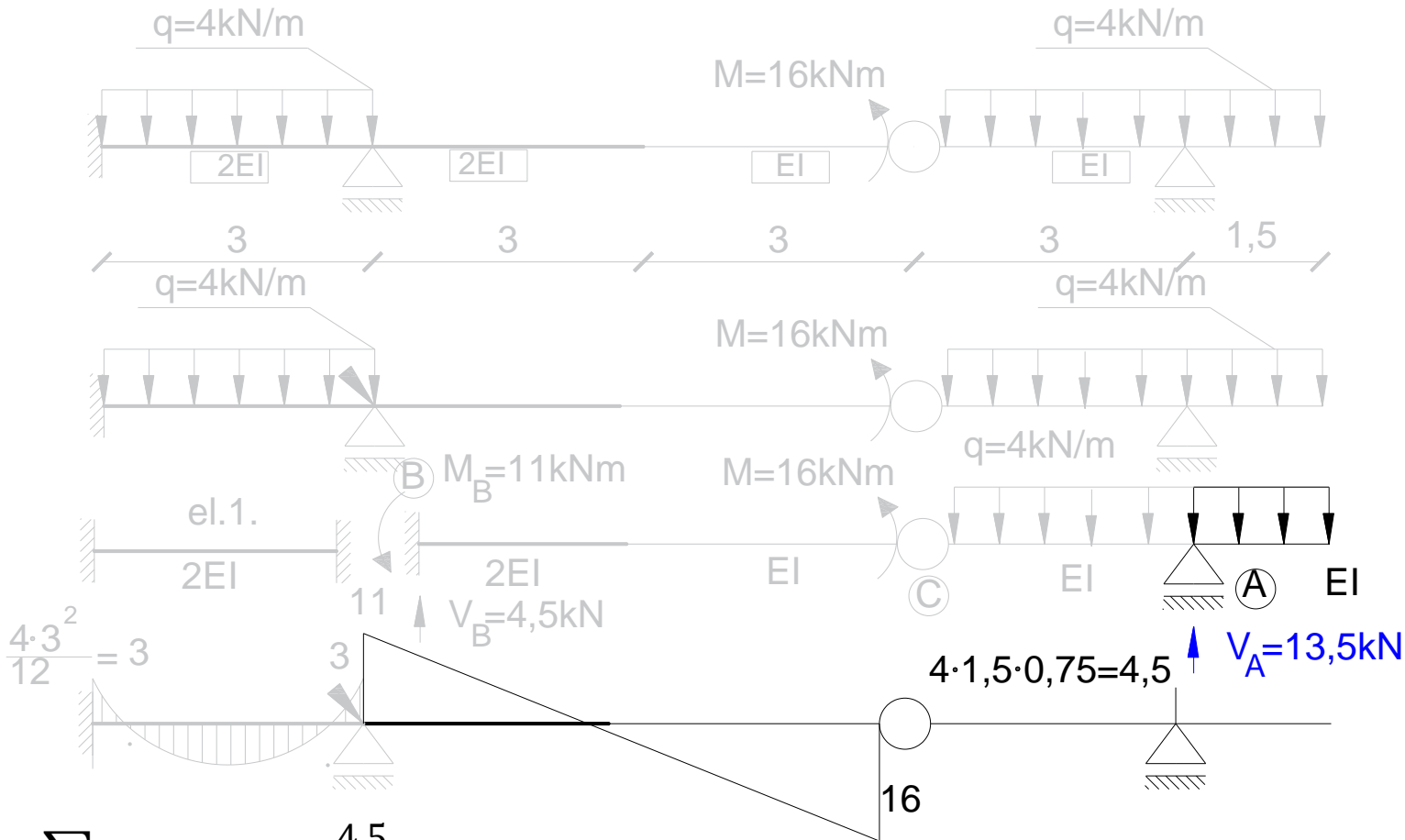

Obciążenie zewnętrzne

$$\sum M_C^P = 4 \cdot 4,5 \cdot \frac{4,5}{2} - V_A \cdot 3 = 0 \rightarrow V_A = 13,5\text{kN}$$

$$\sum R_y = V_B - 4 \cdot 4,5 + 13,5 = 0 \rightarrow V_B = 4,5\text{kN}$$

$$\sum M_C^L = -M_B - 16 + 4,5 \cdot 6 = 0 \rightarrow M_B = 11\text{kNm}$$

# Wykresy jednostkowe i od obciążenia zewnętrznego:

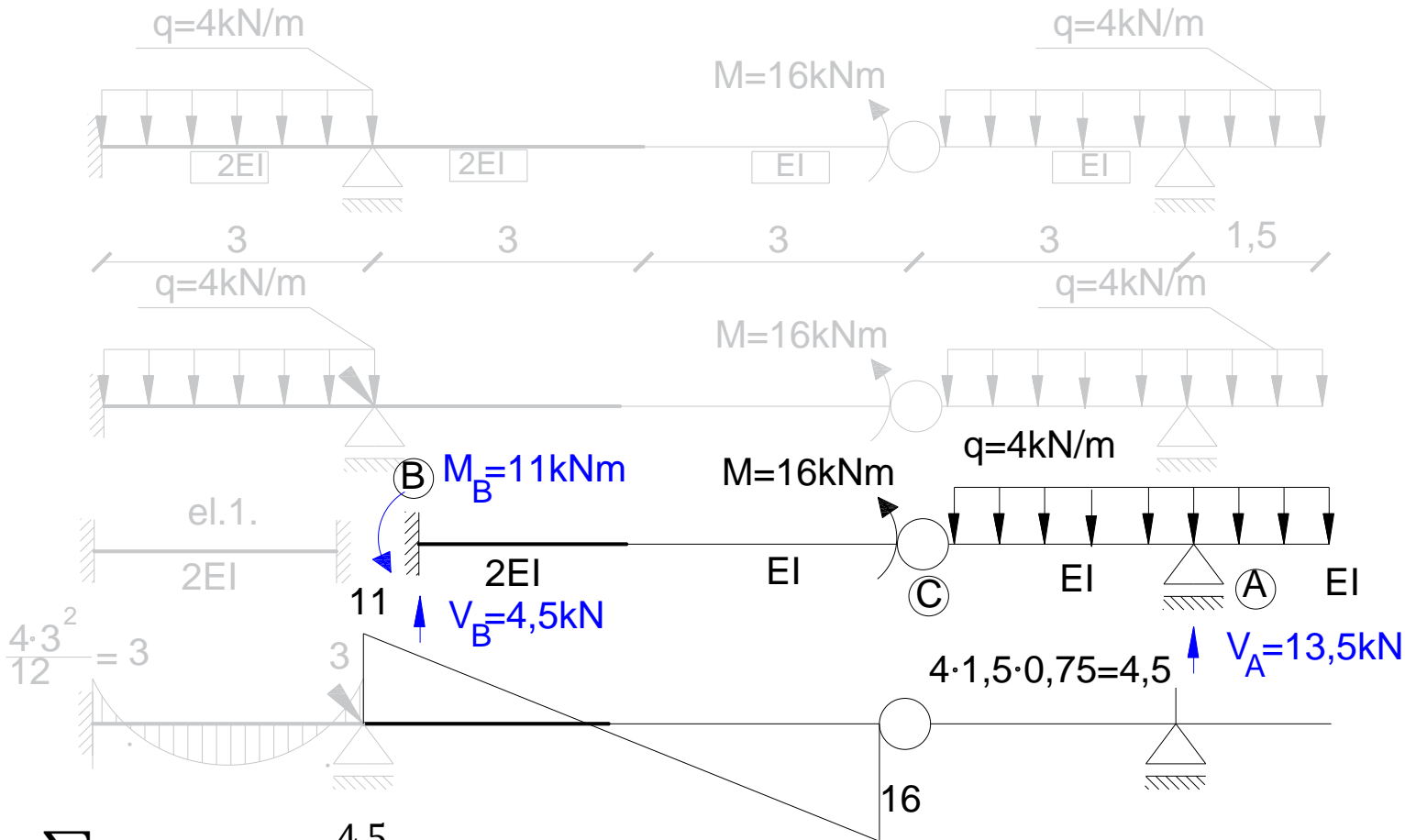

Obciążenie zewnętrzne

$$\sum M_C^P = 4 \cdot 4,5 \cdot \frac{4,5}{2} - V_A \cdot 3 = 0 \rightarrow V_A = 13,5\text{kN}$$

$$\sum R_y = V_B - 4 \cdot 4,5 + 13,5 = 0 \rightarrow V_B = 4,5\text{kN}$$

$$\sum M_C^L = -M_B - 16 + 4,5 \cdot 6 = 0 \rightarrow M_B = 11\text{kNm}$$

# Wykresy jednostkowe i od obciążenia zewnętrznego:

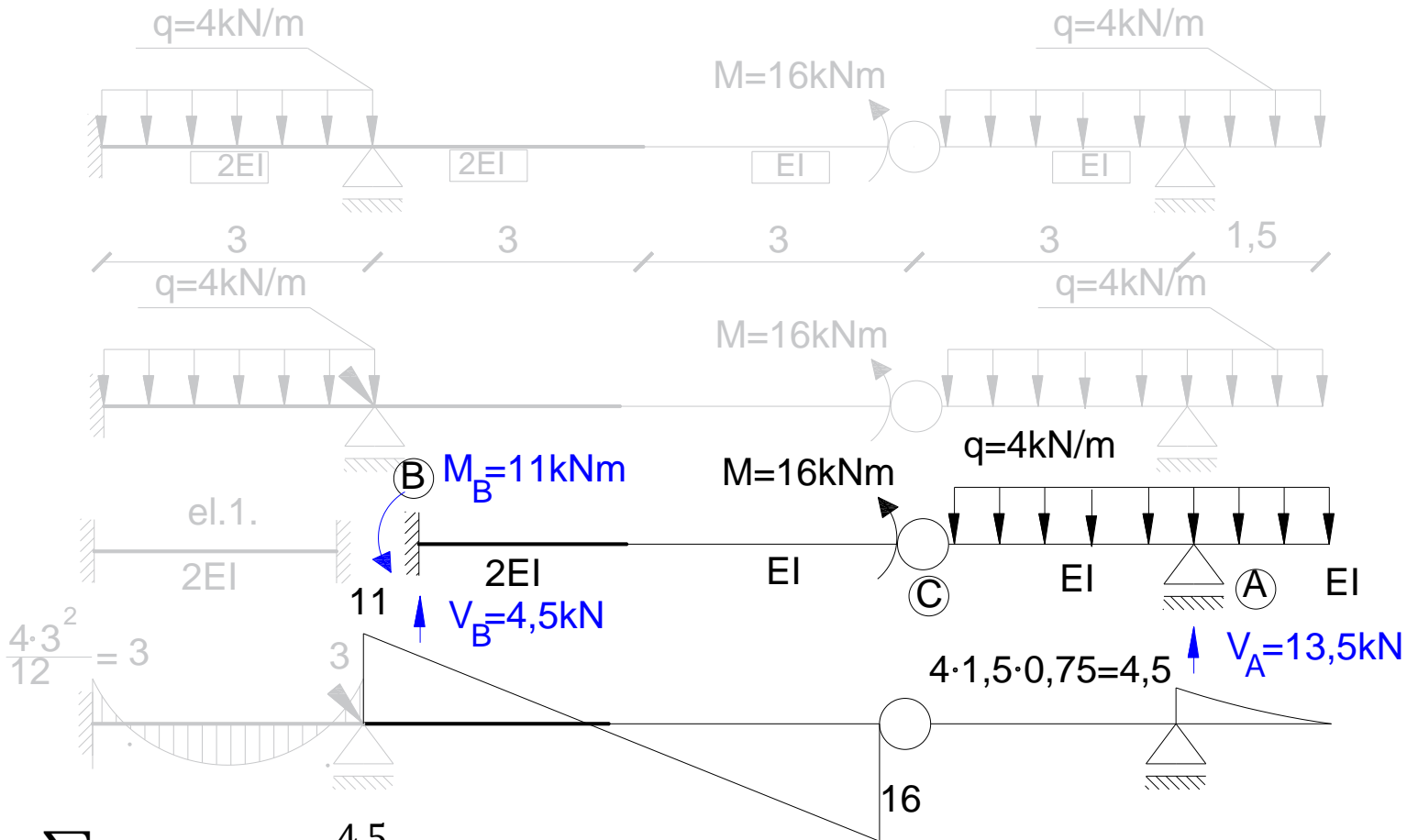

Obciążenie zewnętrzne

$$\sum M_C^P = 4 \cdot 4,5 \cdot \frac{4,5}{2} - V_A \cdot 3 = 0 \rightarrow V_A = 13,5\text{kN}$$

$$\sum R_y = V_B - 4 \cdot 4,5 + 13,5 = 0 \rightarrow V_B = 4,5\text{kN}$$

$$\sum M_C^L = -M_B - 16 + 4,5 \cdot 6 = 0 \rightarrow M_B = 11\text{kNm}$$

# Wykresy jednostkowe i od obciążenia zewnętrznego:

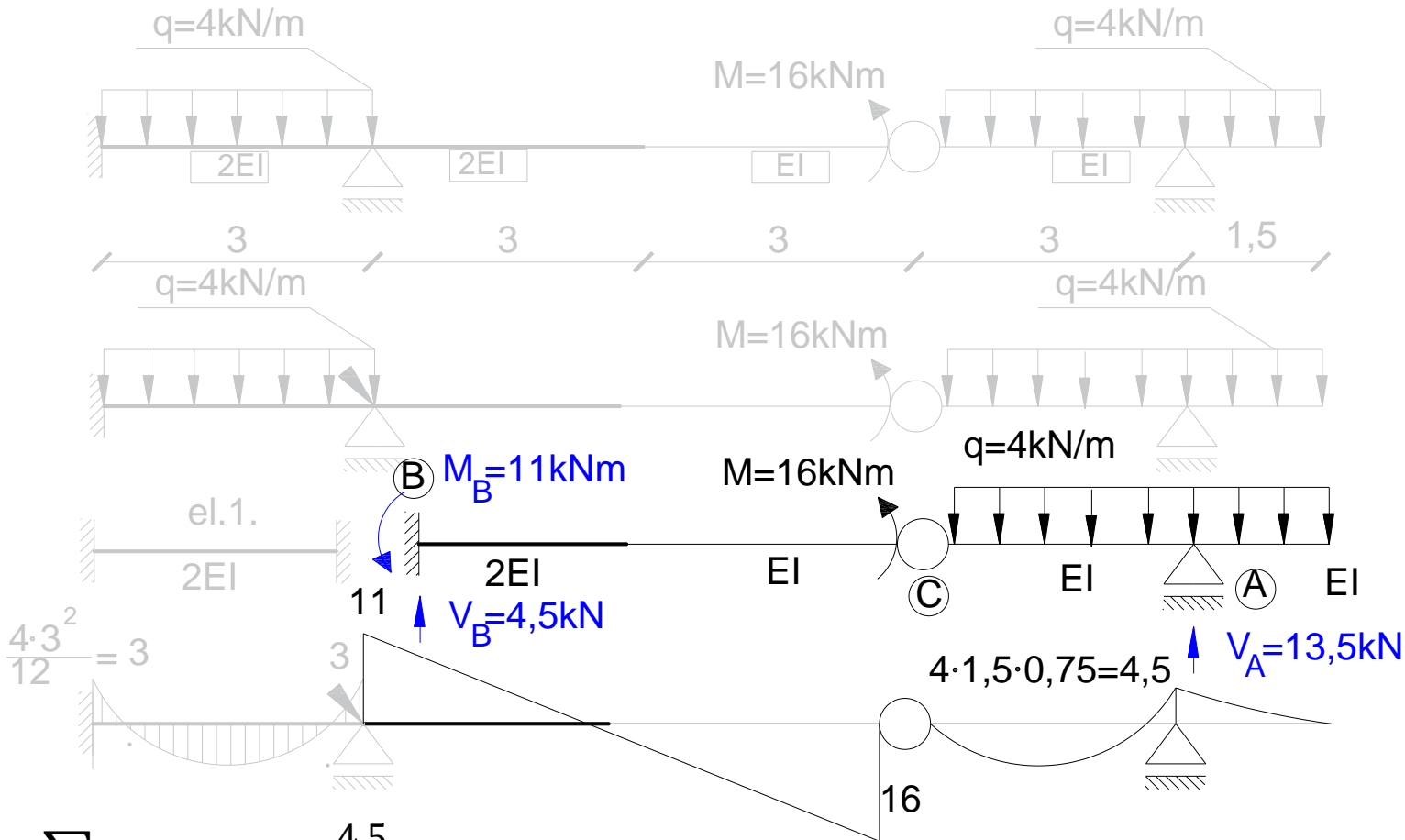

Obciążenie zewnętrzne

$$\sum M_C^P = 4 \cdot 4,5 \cdot \frac{4,5}{2} - V_A \cdot 3 = 0 \rightarrow V_A = 13,5\text{kN}$$

$$\sum R_y = V_B - 4 \cdot 4,5 + 13,5 = 0 \rightarrow V_B = 4,5\text{kN}$$

$$\sum M_C^L = -M_B - 16 + 4,5 \cdot 6 = 0 \rightarrow M_B = 11\text{kNm}$$

# Wykresy jednostkowe i od obciążenia zewnętrznego:

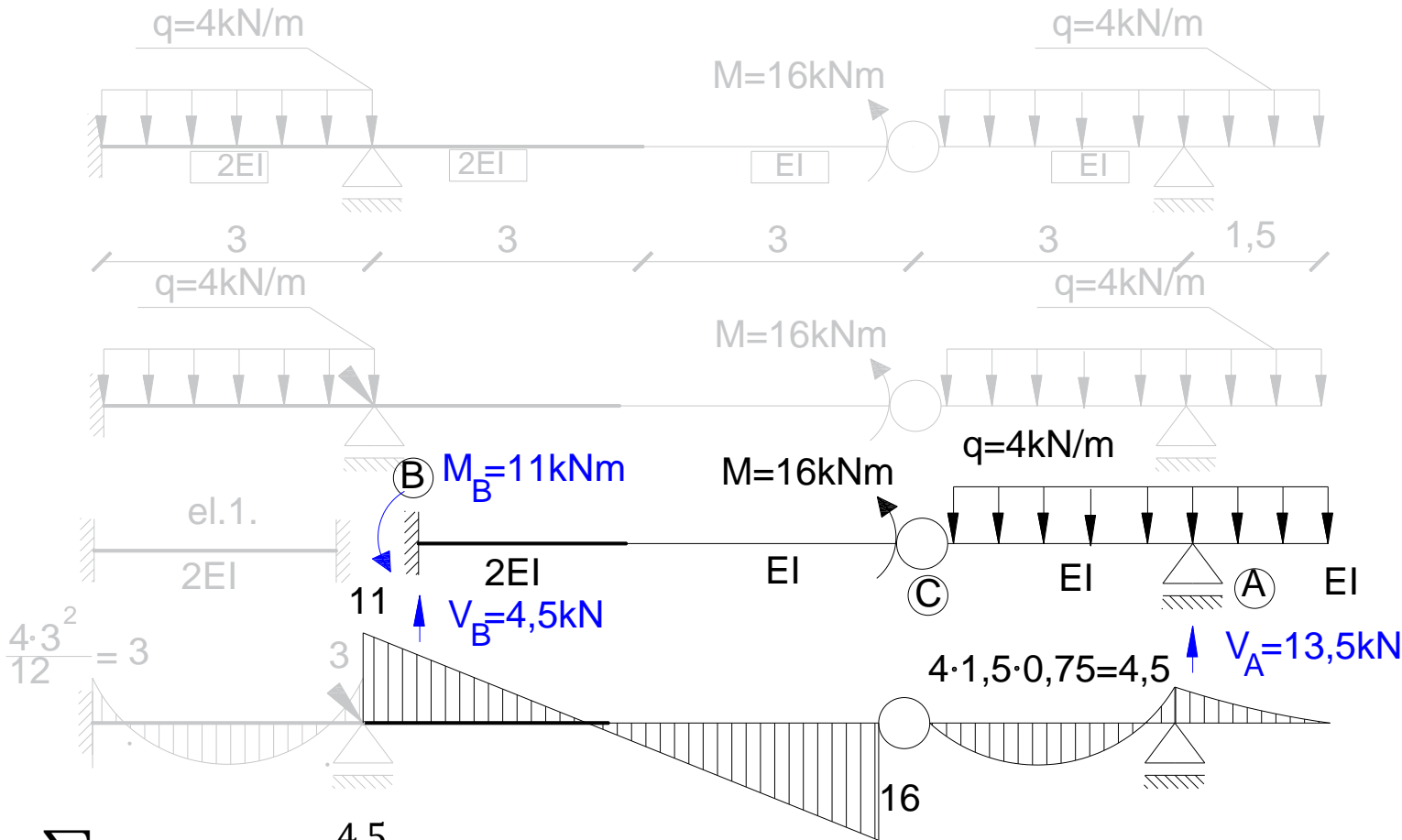

Obciążenie zewnętrzne

$$\sum M_C^P = 4 \cdot 4,5 \cdot \frac{4,5}{2} - V_A \cdot 3 = 0 \rightarrow V_A = 13,5\text{ kN}$$

$$\sum R_y = V_B - 4 \cdot 4,5 + 13,5 = 0 \rightarrow V_B = 4,5\text{ kN}$$

$$\sum M_C^L = -M_B - 16 + 4,5 \cdot 6 = 0 \rightarrow M_B = 11\text{ kNm}$$

# Wykresy jednostkowe i od obciążenia zewnętrznego:

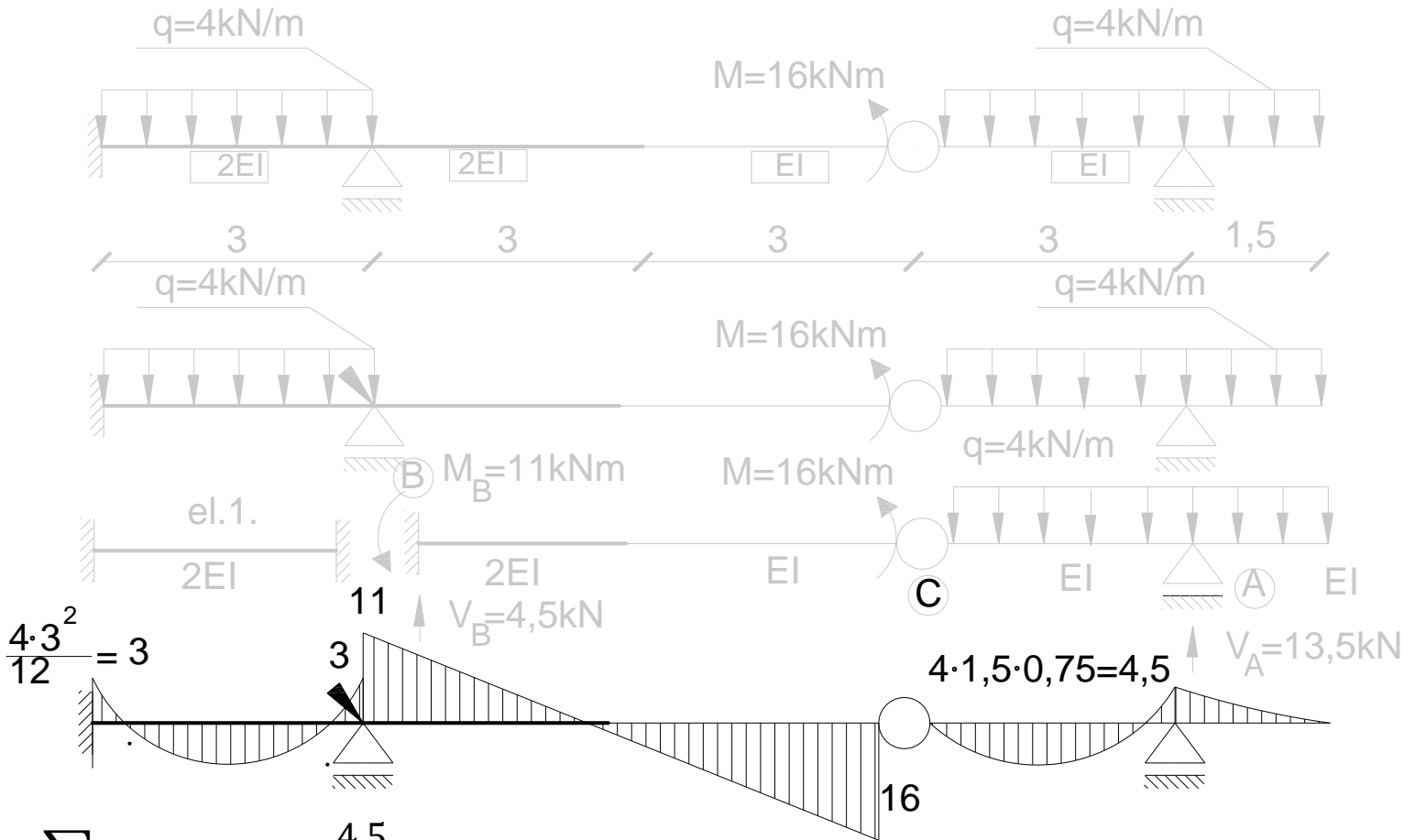

Obciążenie zewnętrzne

$$\sum M_C^P = 4 \cdot 4,5 \cdot \frac{4,5}{2} - V_A \cdot 3 = 0 \rightarrow V_A = 13,5\text{kN}$$

$$\sum R_y = V_B - 4 \cdot 4,5 + 13,5 = 0 \rightarrow V_B = 4,5\text{kN}$$

$$\sum M_C^L = -M_B - 16 + 4,5 \cdot 6 = 0 \rightarrow M_B = 11\text{kNm}$$



# Wykresy jednostkowe i od obciążenia zewnętrznego:

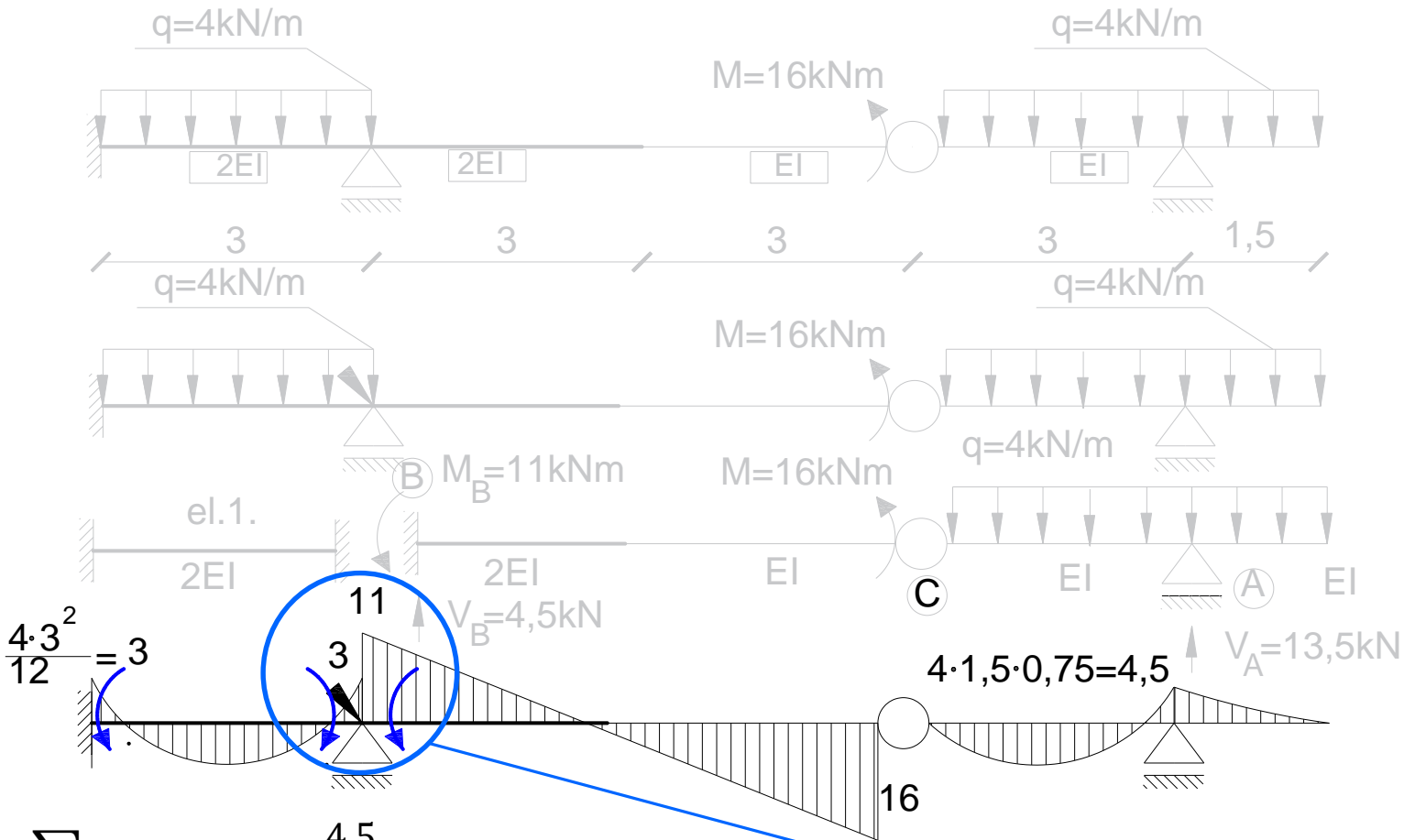

Obciążenie zewnętrzne

$$\sum M_C^P = 4 \cdot 4,5 \cdot \frac{4,5}{2} - V_A \cdot 3 = 0 \rightarrow V_A = 13,5 \text{ kN}$$

$$\sum R_y = V_B - 4 \cdot 4,5 + 13,5 = 0 \rightarrow V_B = 4,5 \text{ kN}$$

$$\sum M_C^L = -M_B - 16 + 4,5 \cdot 6 = 0 \rightarrow M_B = 11 \text{ kNm}$$

$$k_{10} = 3 - 11 = -8 \text{ kNm}$$

# Wykresy jednostkowe i od obciążenia zewnętrznego:

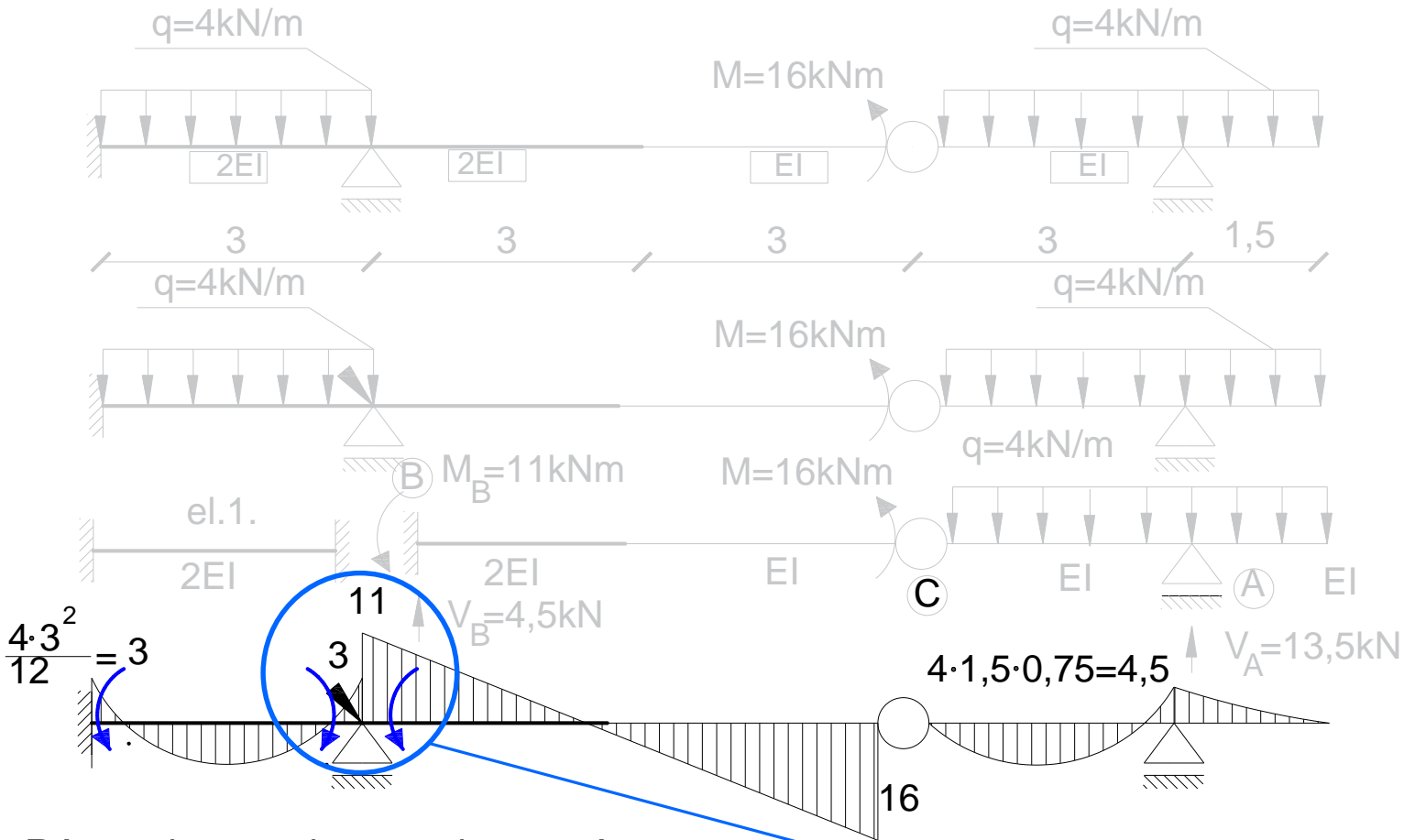

Obciążenie zewnętrzne

Równanie metody przemieszczeń:

$$k_{11} \cdot \varphi_1 + k_{10} = 0$$

$$\frac{8EI}{3} \cdot \varphi_1 - 8 = 0 \rightarrow \varphi_1 = \frac{8 \cdot 3}{8EI} = \frac{3}{EI}$$

$$k_{10} = 3 - 11 = -8\text{ kNm}$$

Dobór schematu podstawowego metody przemieszczeń w belkach  
przy liczeniu przemieszczeń bezpośrednio z układu :

- Dobieramy niezbędne blokady w minimalnej ilości niewiadomych (tak jak dla wyznaczenia wykresu  $M$ )
- Przy liczeniu ugięcia na końcu wspornika wstawiamy samą blokadę na przesunięcie,
- Przy liczeniu kąta obrotu na końcu wspornika wstawiamy obie blokady (na obrót i na przesunięcie),
- Przy liczeniu dowolnego przemieszczenia na belce między podporami (w środku układu) – stawiamy obie blokady jednocześnie,
- Uzupełniamy układ brakującymi blokadami.

**Zadanie 2.:** Wyznaczyć kąt obrotu po prawej stronie przegubu bezpośrednio z układu równań metody przemieszczeń. Zadanie rozwiąż w minimalnej bazie niewiadomych.

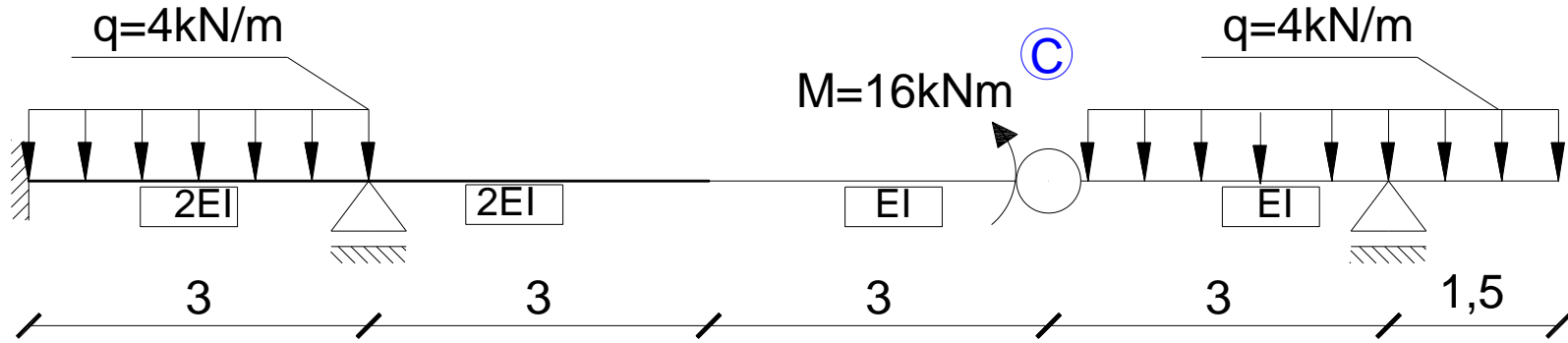

$$\varphi_C^P = ?$$

# Schemat podstawowy geometrycznie wyznaczalny

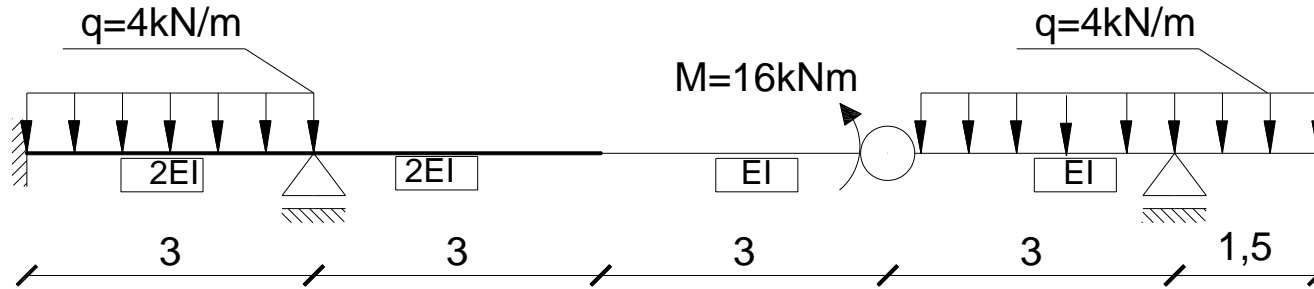

Schemat w minimalnej  
bazie niewiadomych

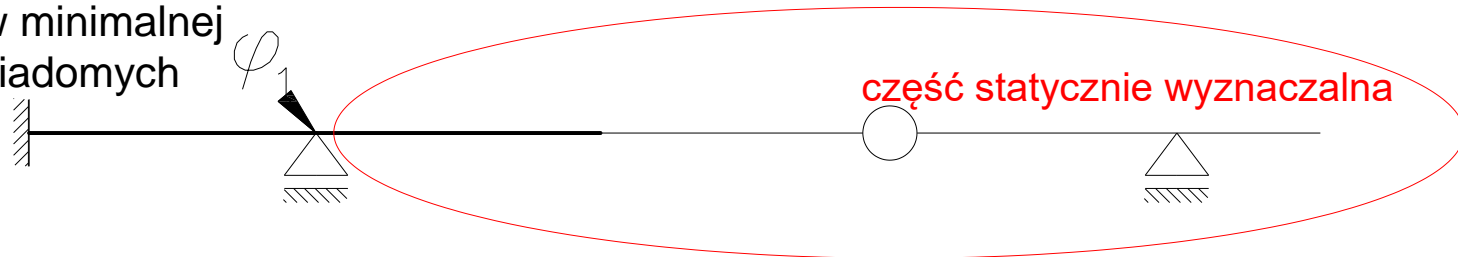

# Schemat podstawowy geometrycznie wyznaczalny

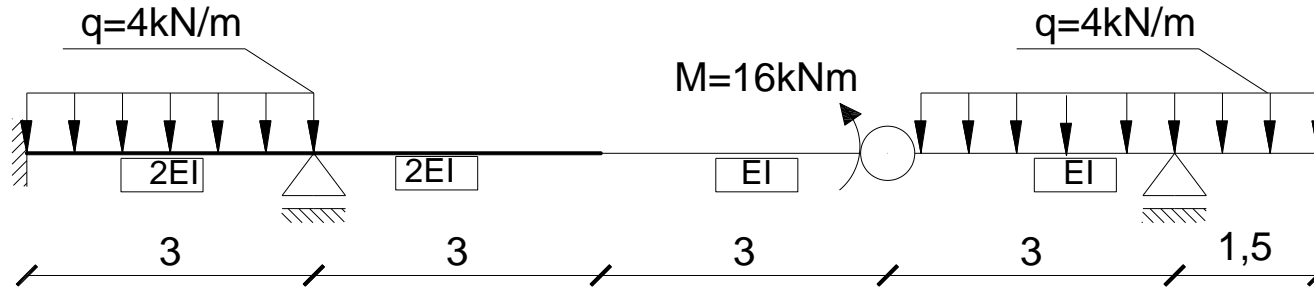

Schemat w minimalnej  
bazie niewiadomych

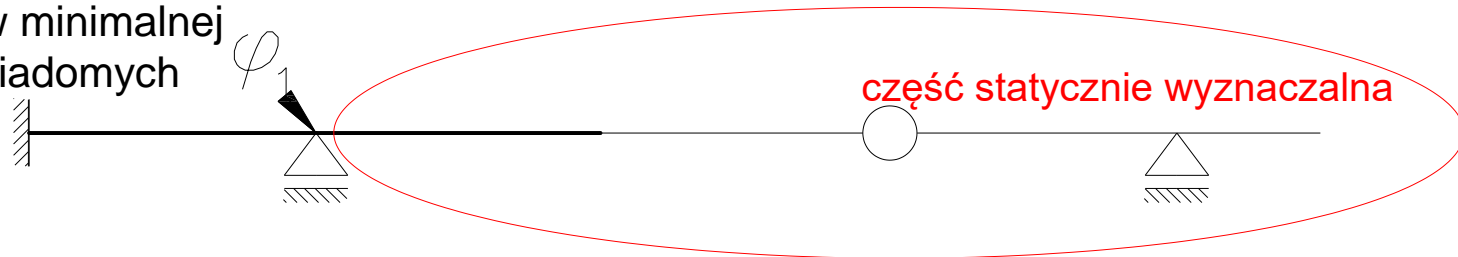

Schemat do liczenia  
przemieszczenia



# Schemat podstawowy geometrycznie wyznaczalny

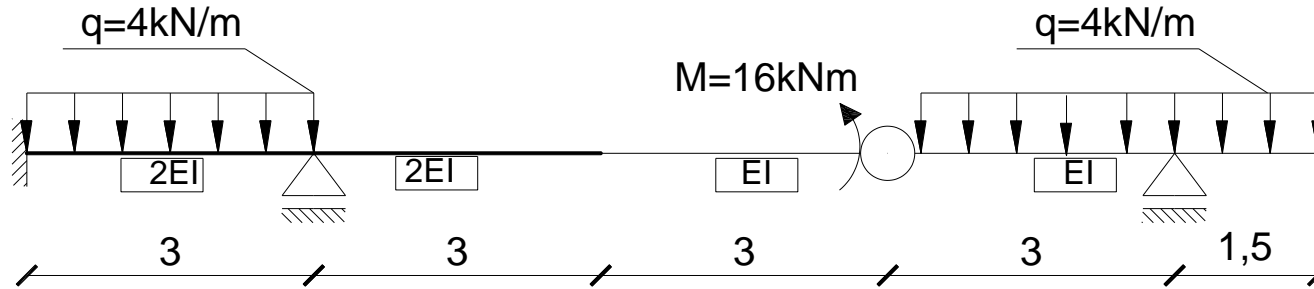

Schemat w minimalnej  
bazie niewiadomych

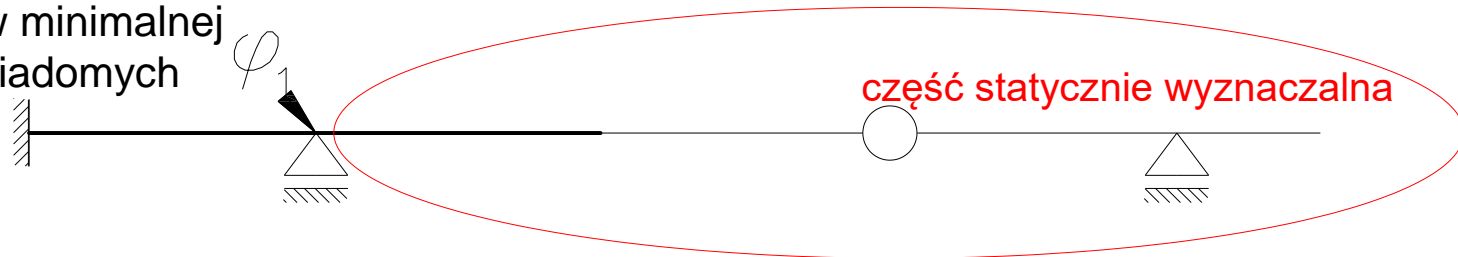

Schemat do liczenia  
przemieszczenia



# Schemat podstawowy geometrycznie wyznaczalny

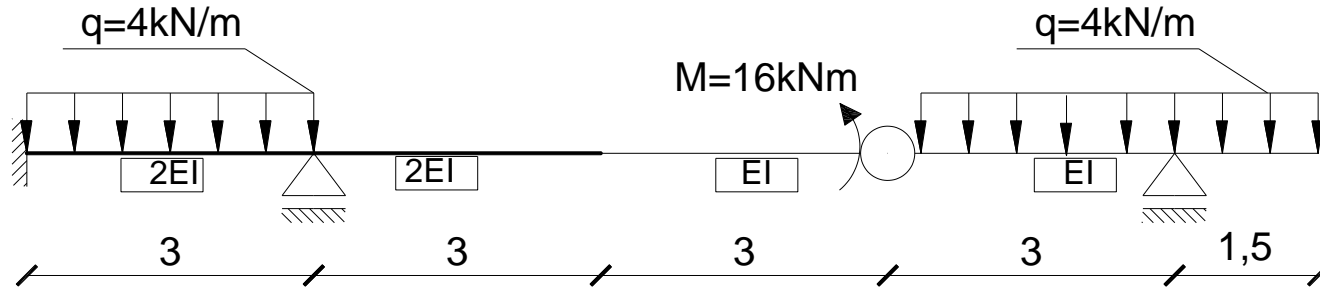

Schemat w minimalnej  
bazie niewiadomych

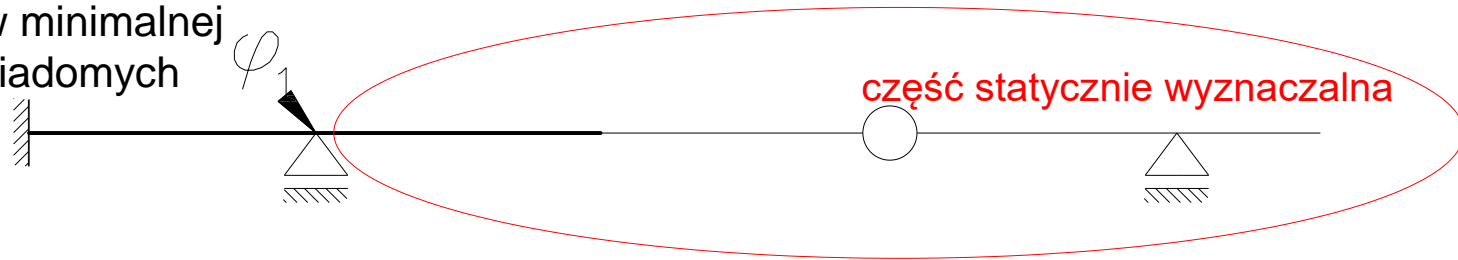

Schemat do liczenia  
przemieszczenia

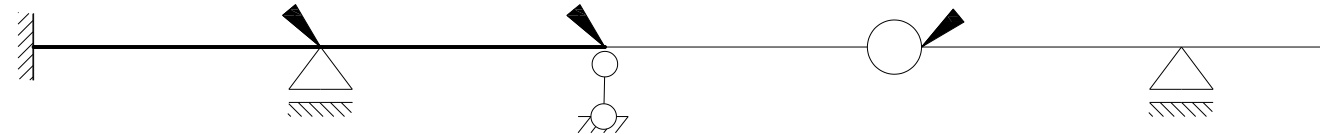



# Schemat podstawowy geometrycznie wyznaczalny

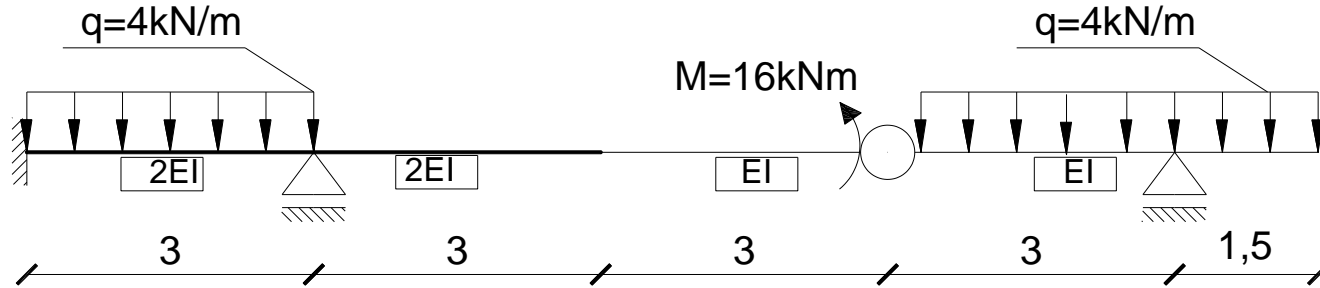

Schemat w minimalnej  
bazie niewiadomych

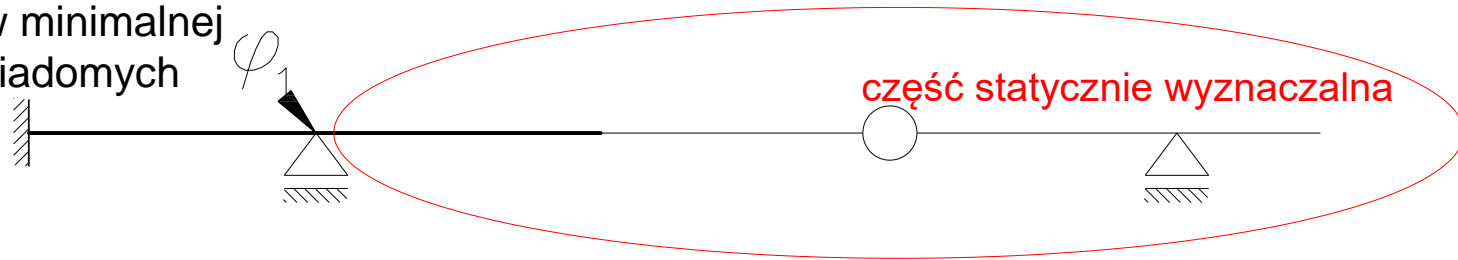

Schemat do liczenia  
przemieszczenia

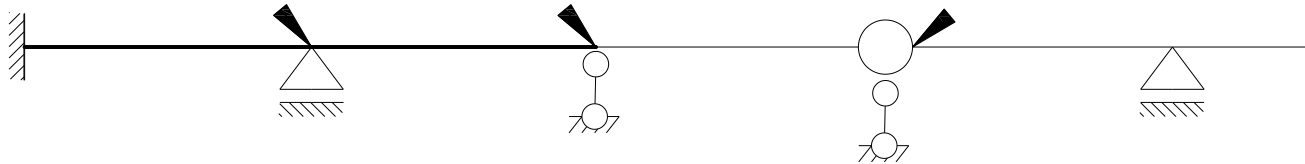

# Schemat podstawowy geometrycznie wyznaczalny

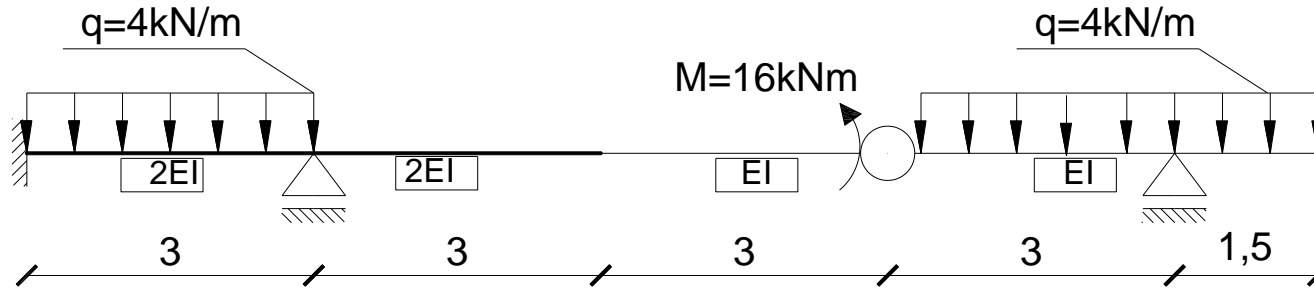

Schemat w minimalnej  
bazie niewiadomych

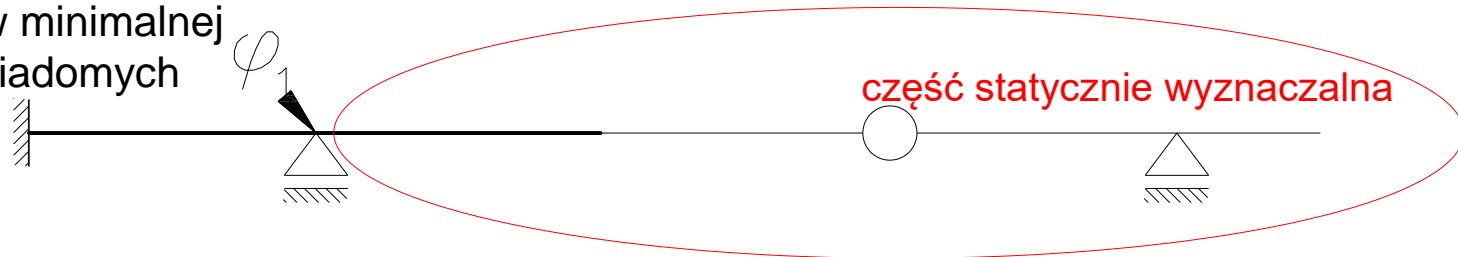

Schemat do liczenia  
przemieszczenia

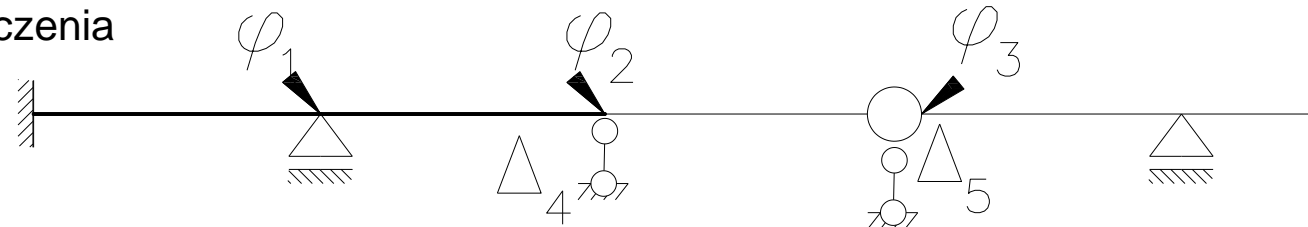

# Schemat podstawowy geometrycznie wyznaczalny

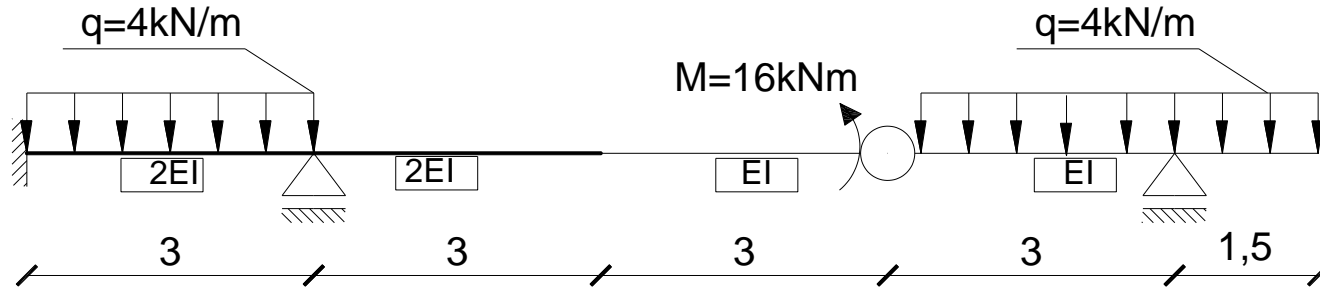

Schemat w minimalnej bazie niewiadomych

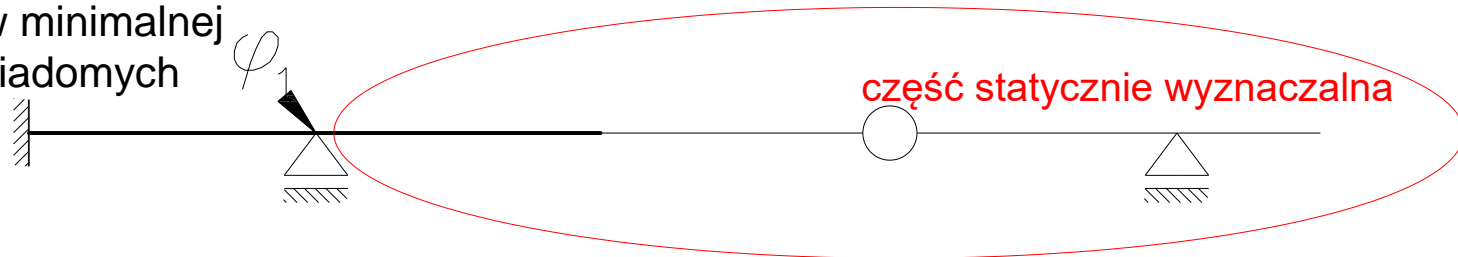

Schemat do liczenia przemieszczenia

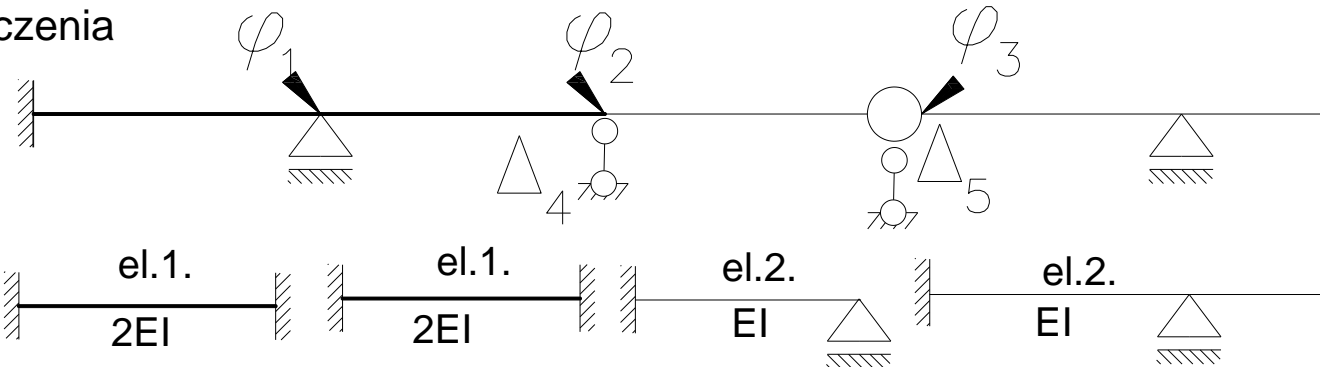

Układ pięciokrotnie geometrycznie niewyznaczalny

$$n_g = 5(\varphi_1, \varphi_2, \varphi_3, \Delta_4, \Delta_5)$$

Układ pięciokrotnie geometrycznie niewyznaczalny

$$n_g = 5(\varphi_1, \varphi_2, \varphi_3, \Delta_4, \Delta_5)$$

Układ równań metody przemieszczeń:

$$k_{11} \cdot \varphi_1 + k_{12} \cdot \varphi_2 + k_{13} \cdot \varphi_3 + k_{14} \cdot \Delta_4 + k_{15} \cdot \Delta_5 + k_{10} = 0$$

$$k_{21} \cdot \varphi_1 + k_{22} \cdot \varphi_2 + k_{23} \cdot \varphi_3 + k_{24} \cdot \Delta_4 + k_{25} \cdot \Delta_5 + k_{20} = 0$$

$$k_{31} \cdot \varphi_1 + k_{32} \cdot \varphi_2 + k_{33} \cdot \varphi_3 + k_{34} \cdot \Delta_4 + k_{35} \cdot \Delta_5 + k_{30} = 0$$

$$k_{41} \cdot \varphi_1 + k_{42} \cdot \varphi_2 + k_{43} \cdot \varphi_3 + k_{44} \cdot \Delta_4 + k_{45} \cdot \Delta_5 + k_{40} = 0$$

$$k_{51} \cdot \varphi_1 + k_{52} \cdot \varphi_2 + k_{53} \cdot \varphi_3 + k_{54} \cdot \Delta_4 + k_{55} \cdot \Delta_5 + k_{50} = 0$$

# Wykresy jednostkowe:

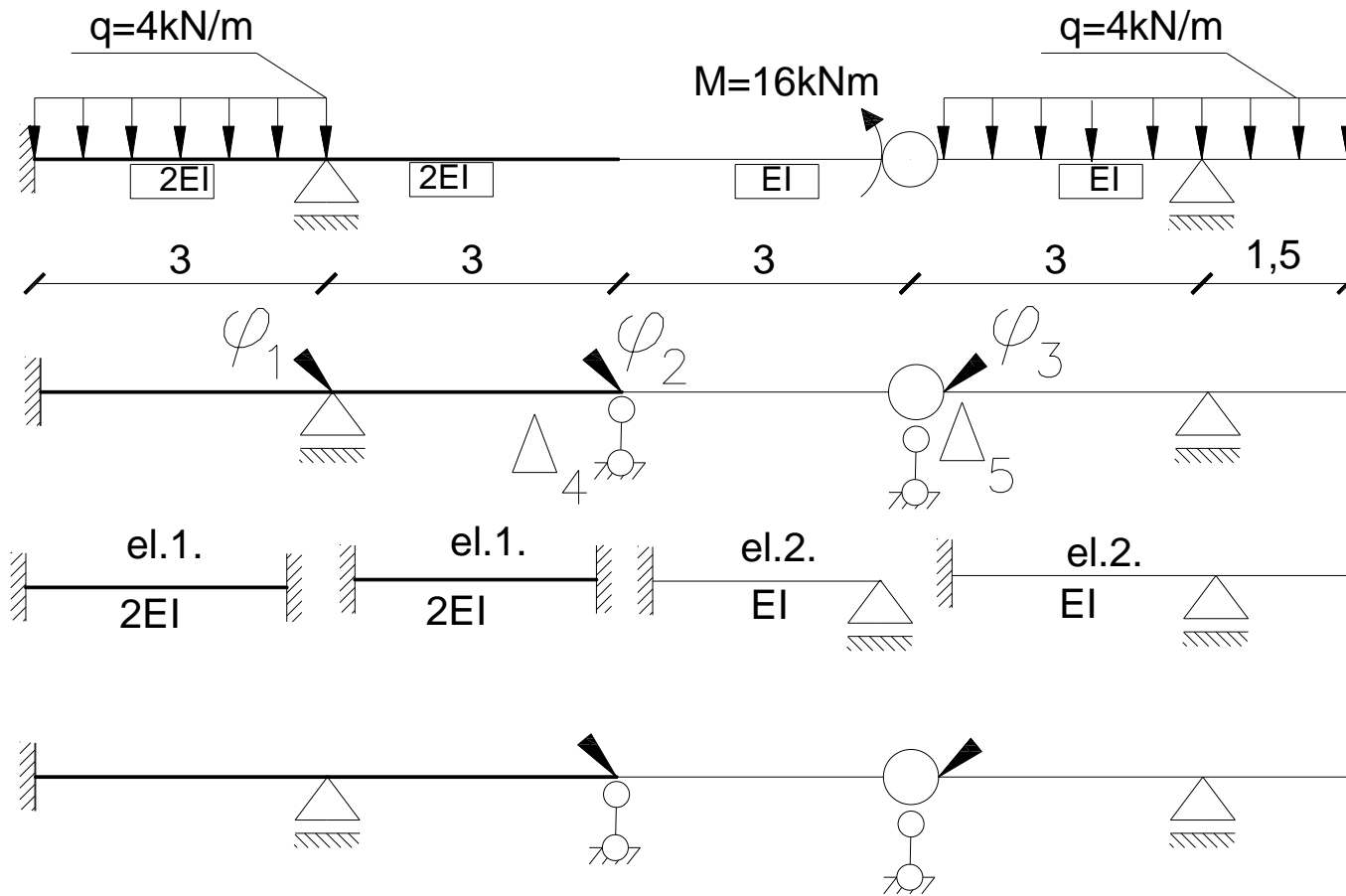

Stan  $\varphi_1=1$

# Wykresy jednostkowe:

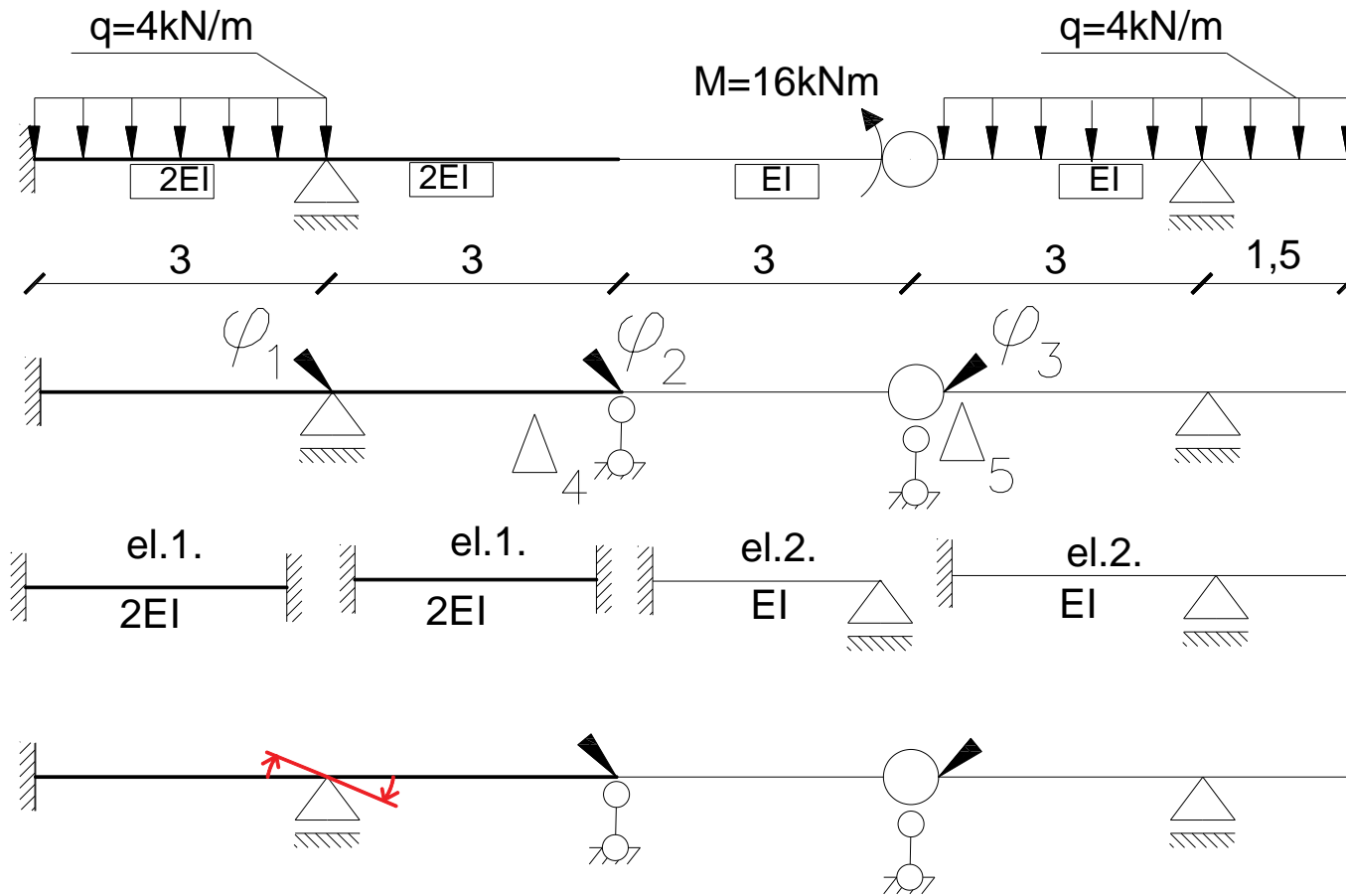

Stan  $\varphi_1=1$

# Wykresy jednostkowe:

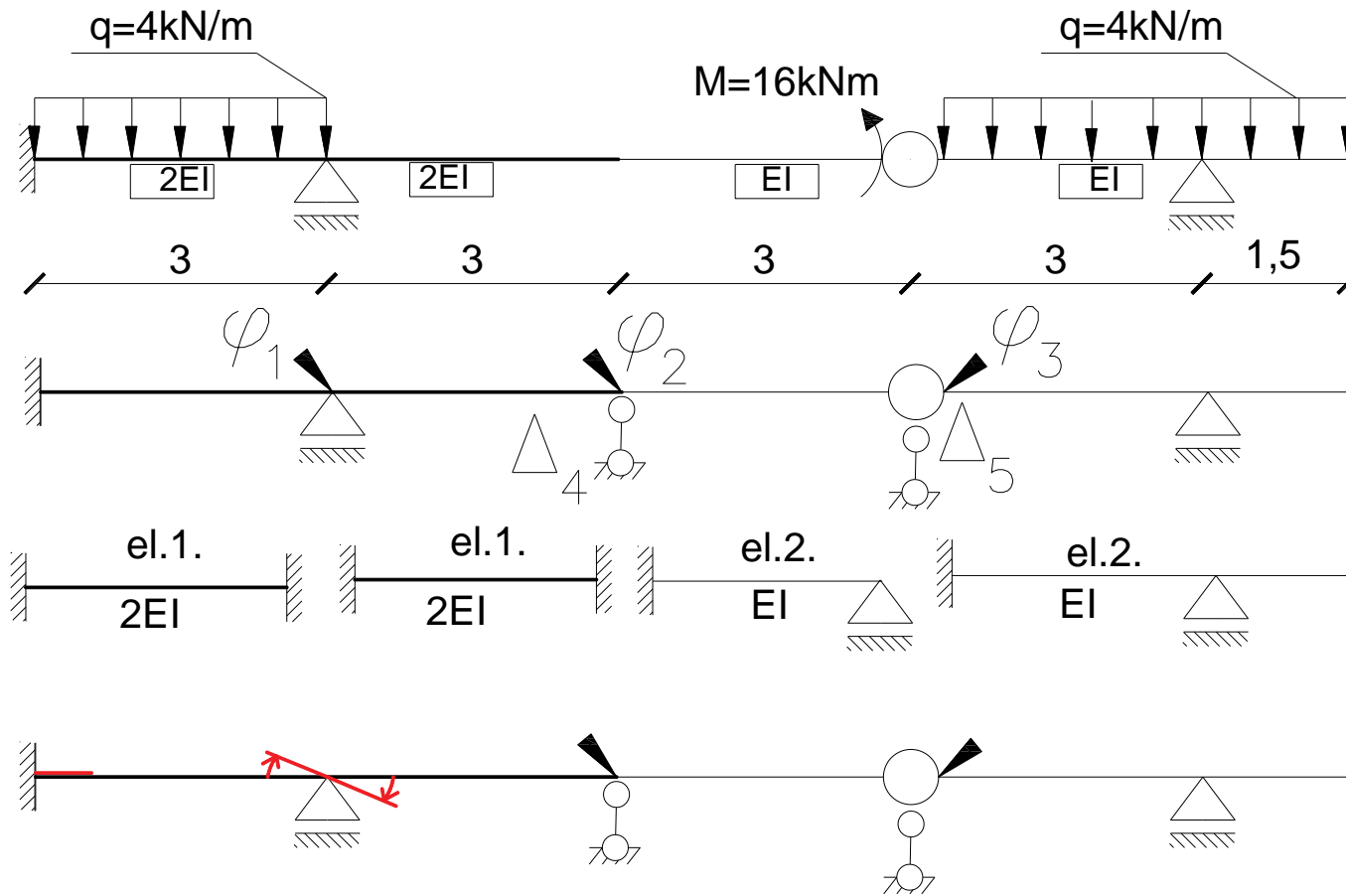

Stan  $\varphi_1=1$

# Wykresy jednostkowe:

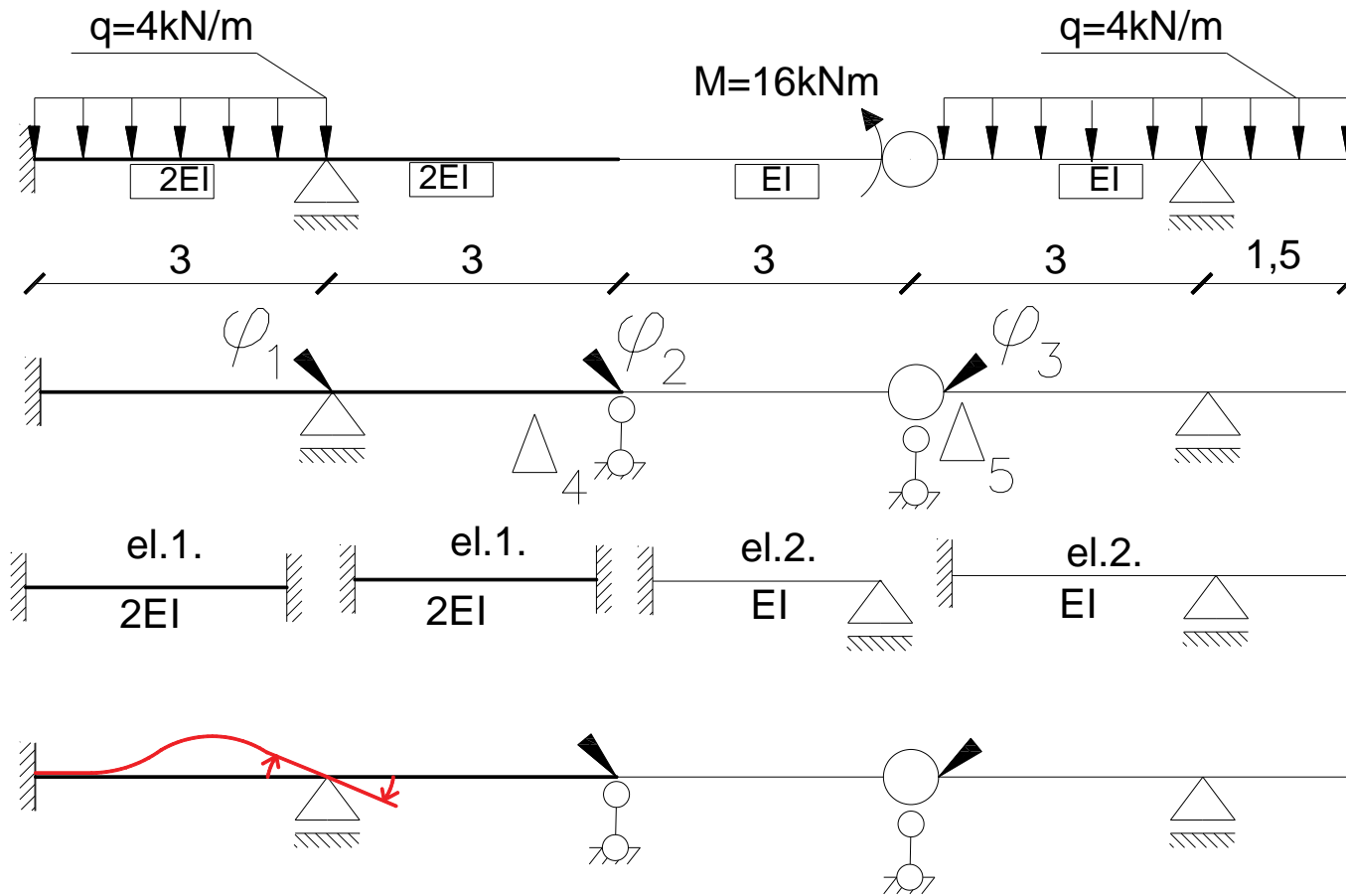

Stan  $\varphi_1=1$



# Wykresy jednostkowe:

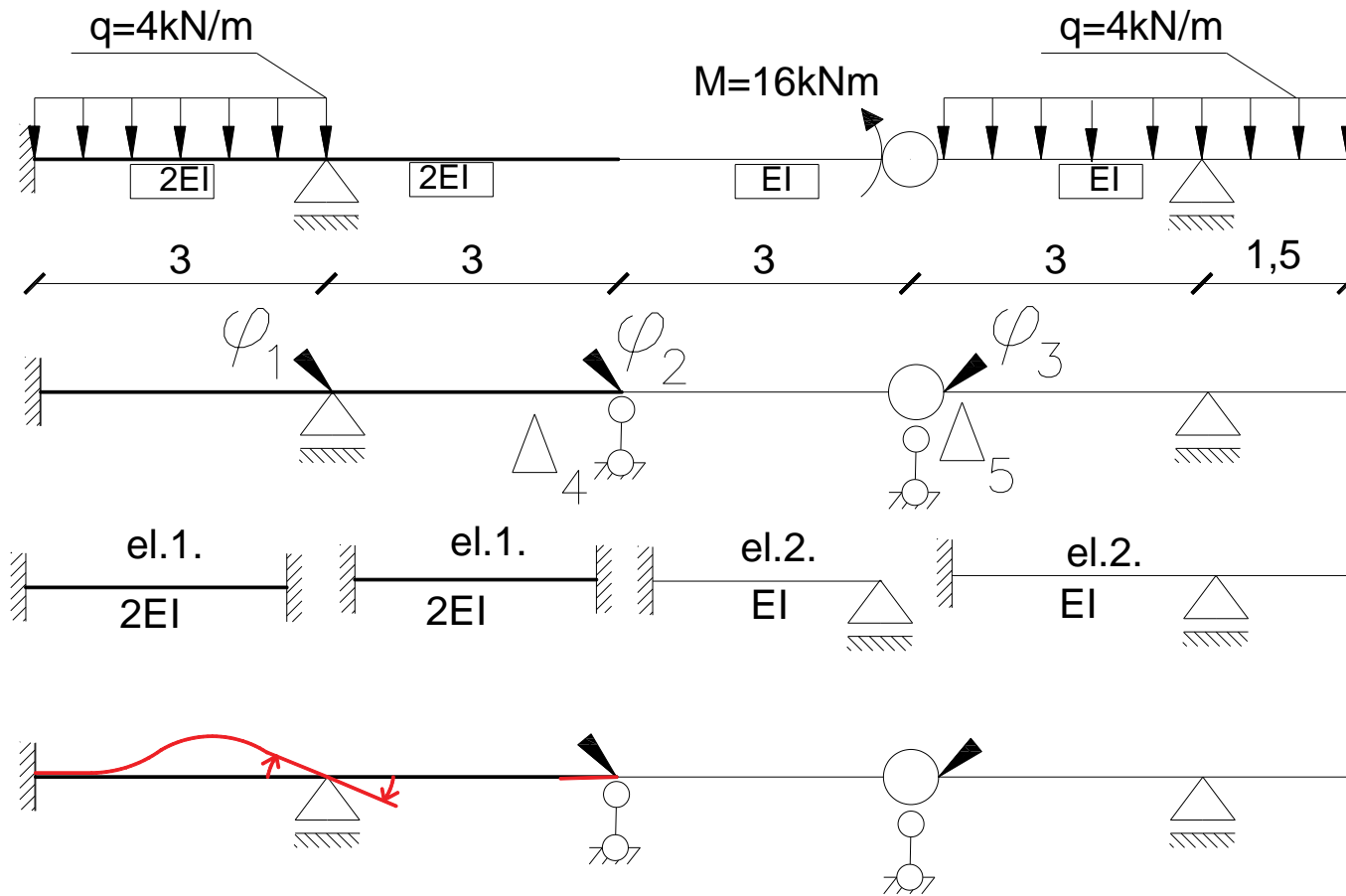

Stan  $\varphi_1=1$

# Wykresy jednostkowe:

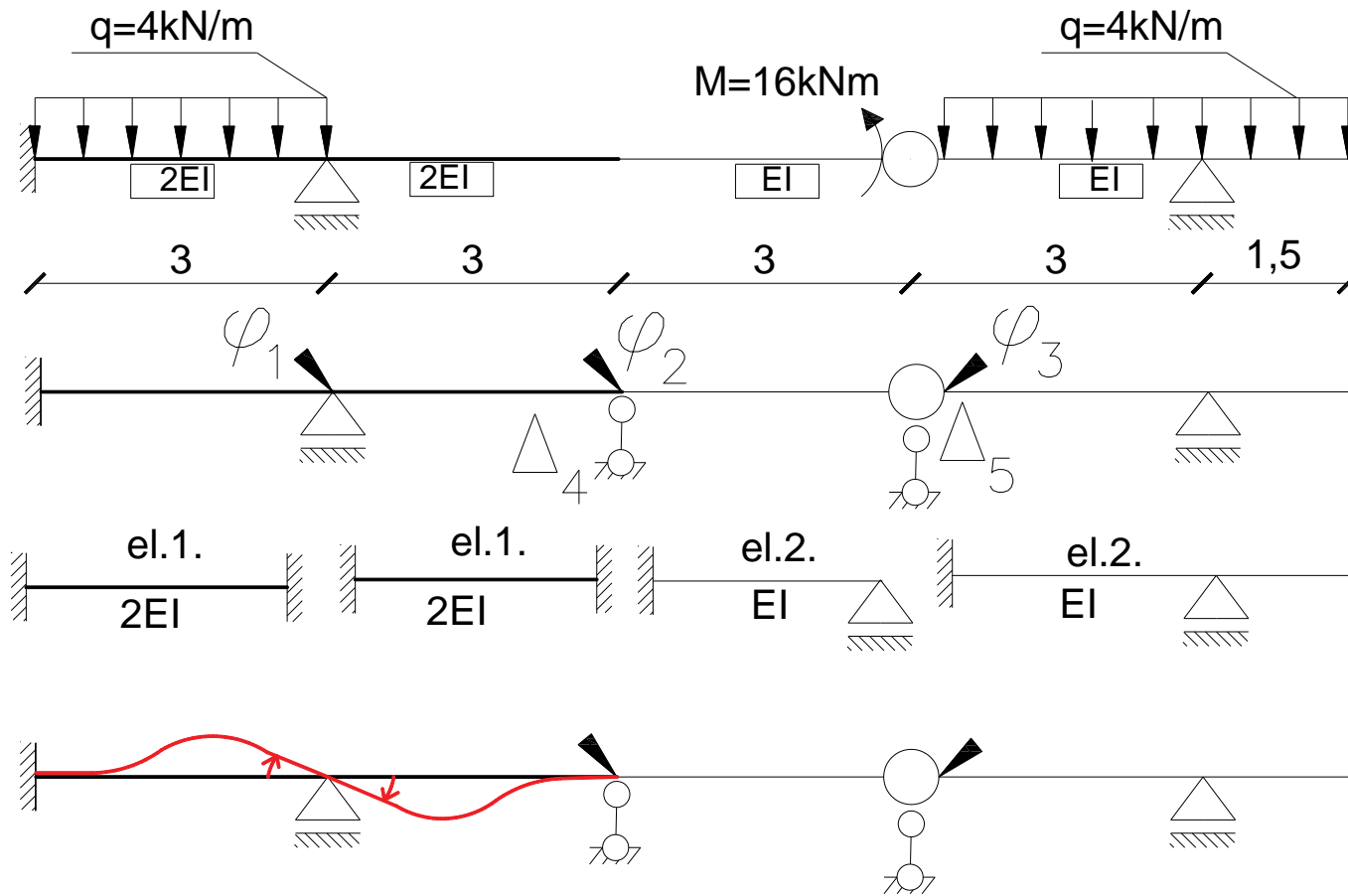

Stan  $\varphi_1=1$

# Wykresy jednostkowe:

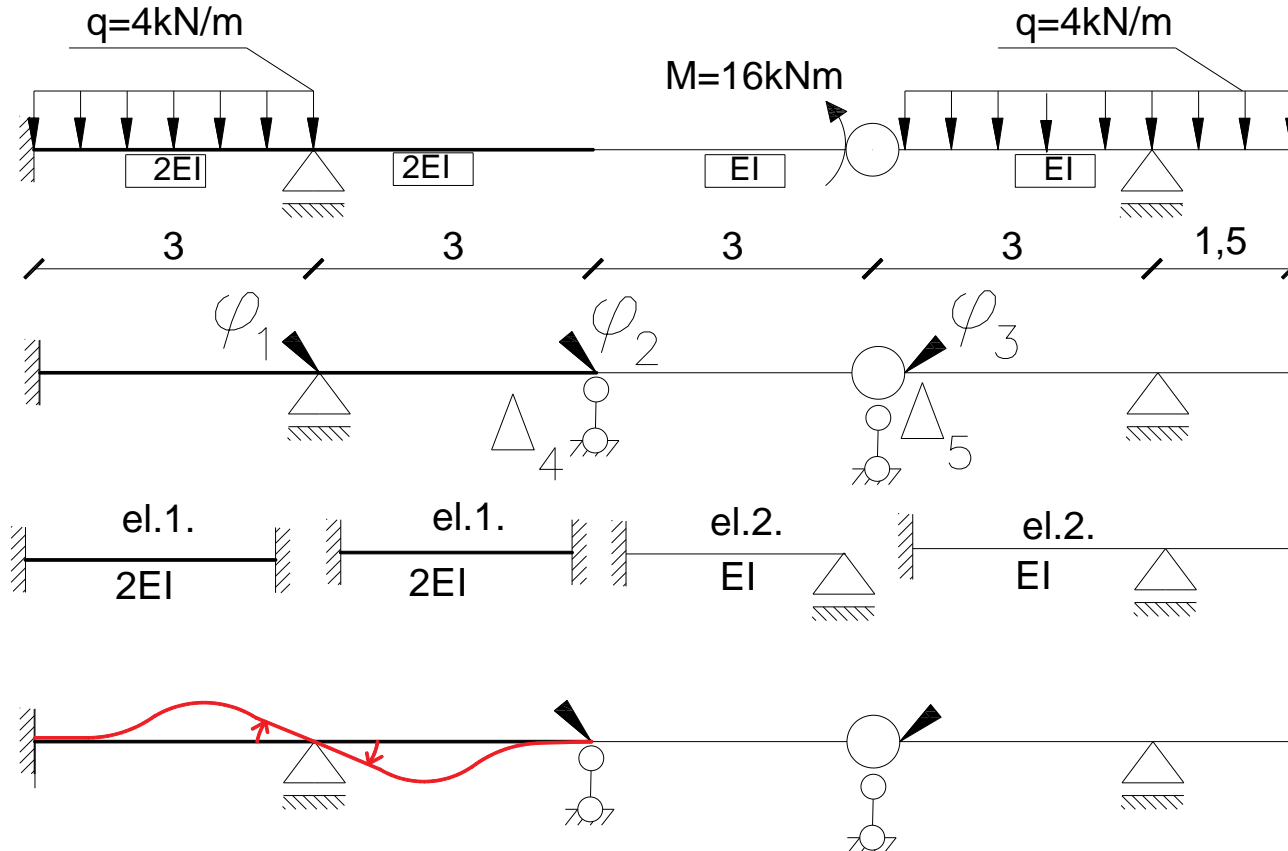

Stan  $\varphi_1=1$

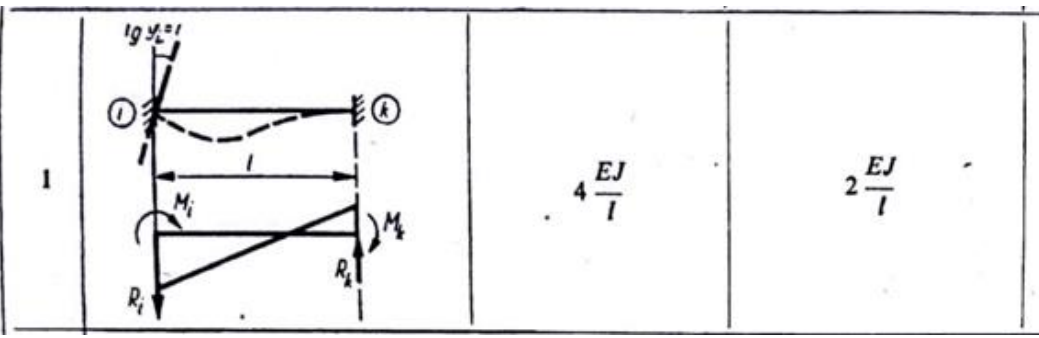

# Wykresy jednostkowe:

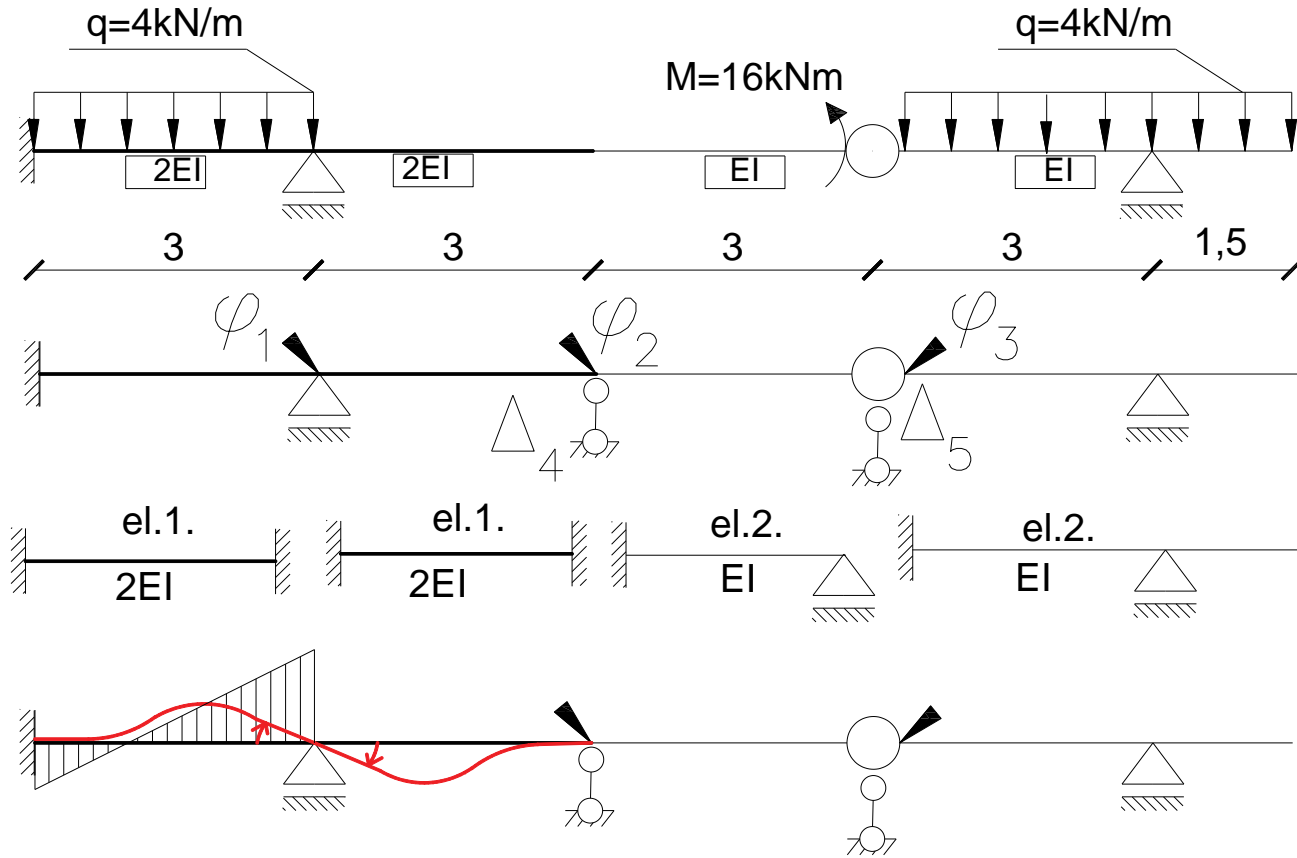

Stan  $\varphi_1=1$

1	<p>Diagram of a beam element of length <math>l</math> with moments <math>M_i</math> and <math>M_k</math> and reactions <math>R_i</math> and <math>R_k</math>.</p>	$4 \frac{EJ}{l}$	$2 \frac{EJ}{l}$
---	---	------------------	------------------

# Wykresy jednostkowe:

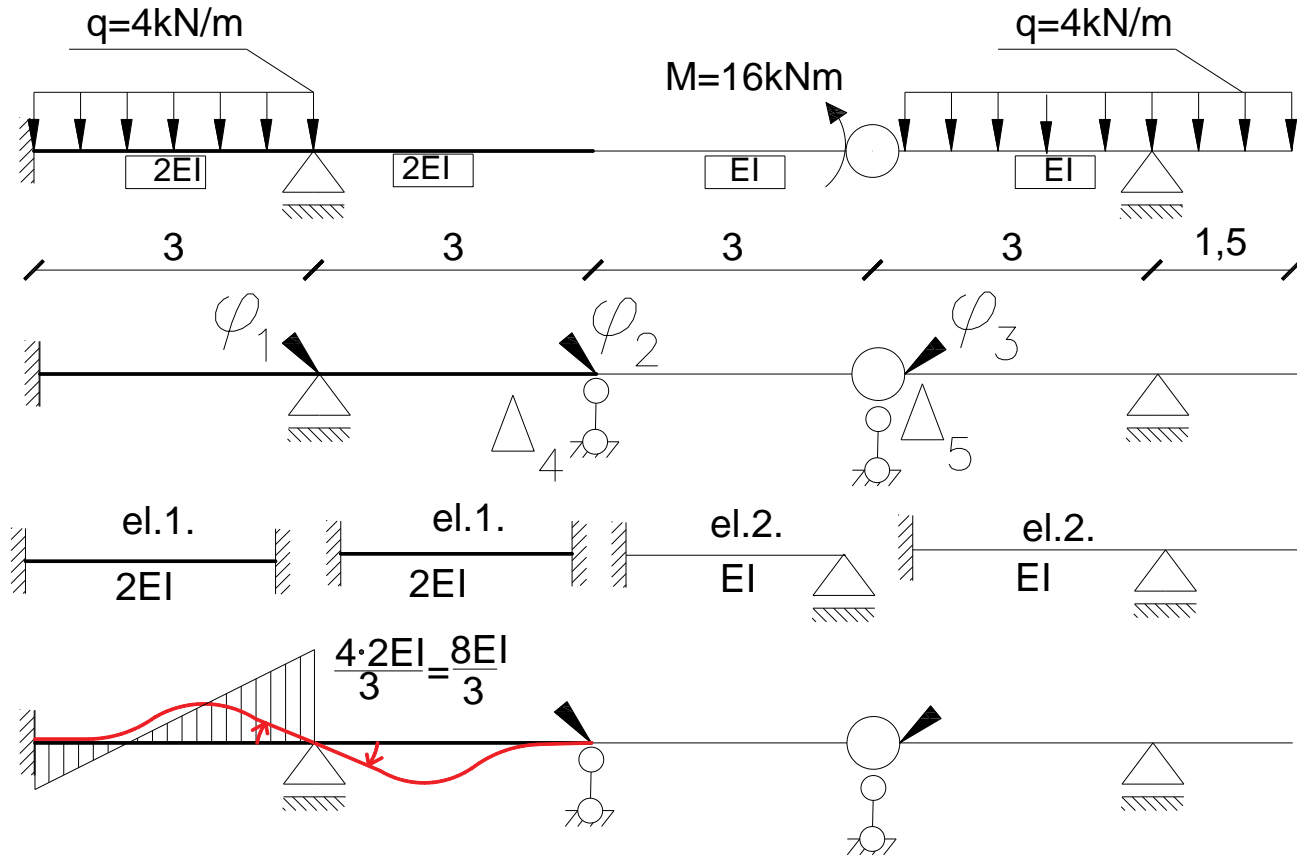

Stan  $\varphi_1=1$

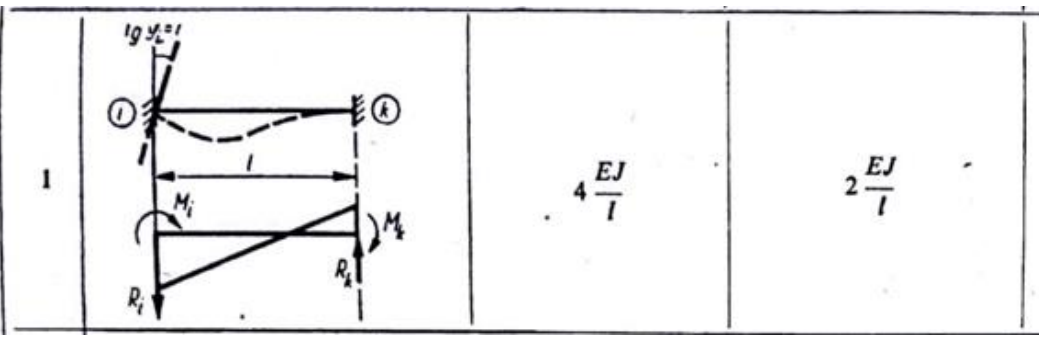

# Wykresy jednostkowe:

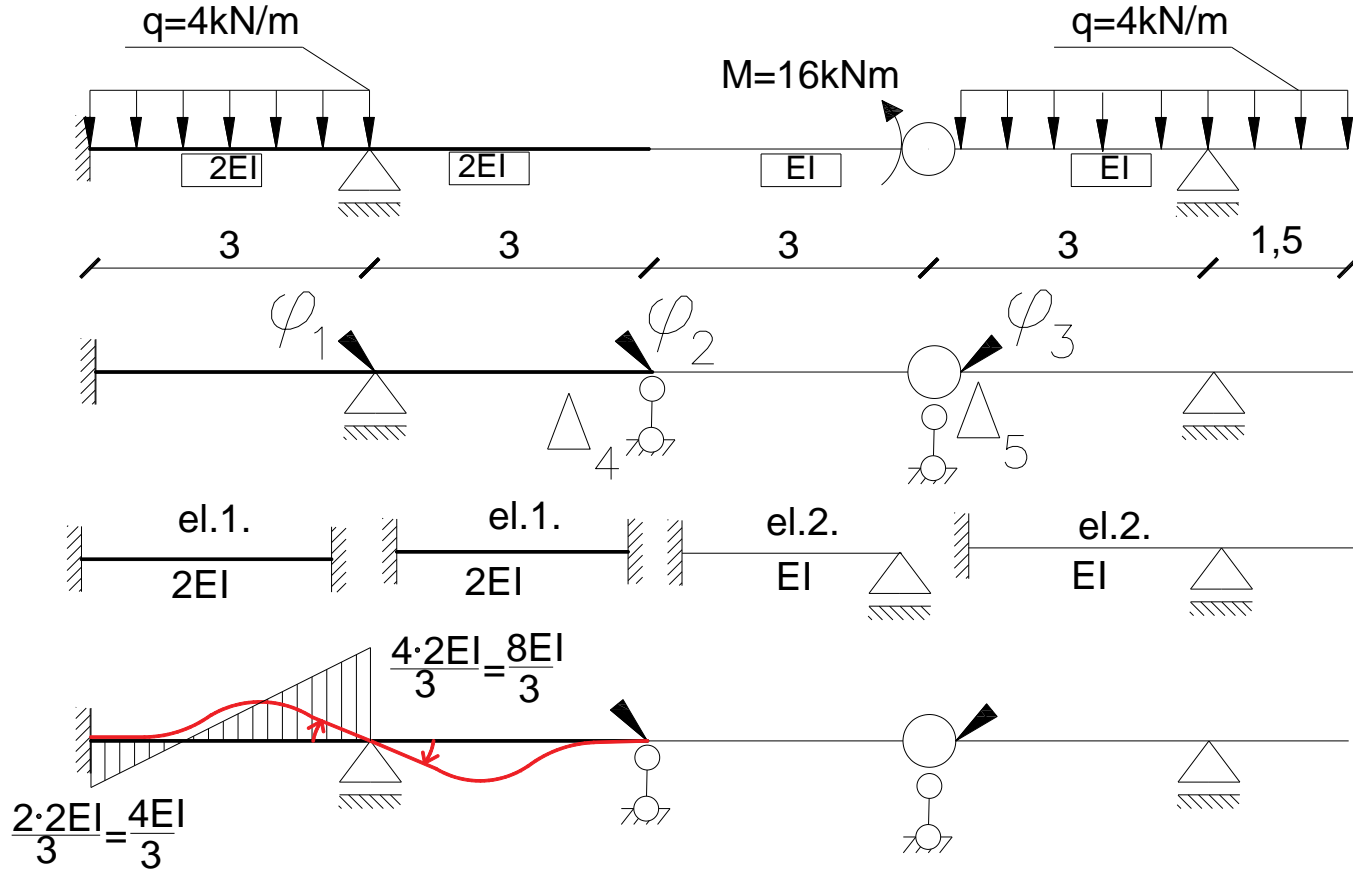

Stan  $\varphi_1=1$

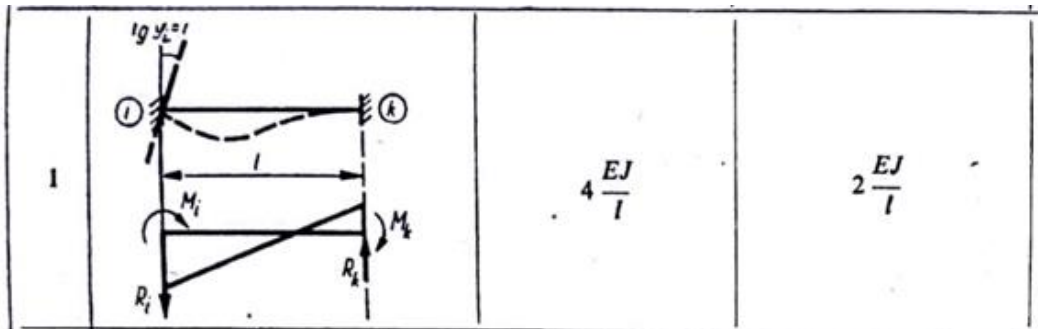

# Wykresy jednostkowe:

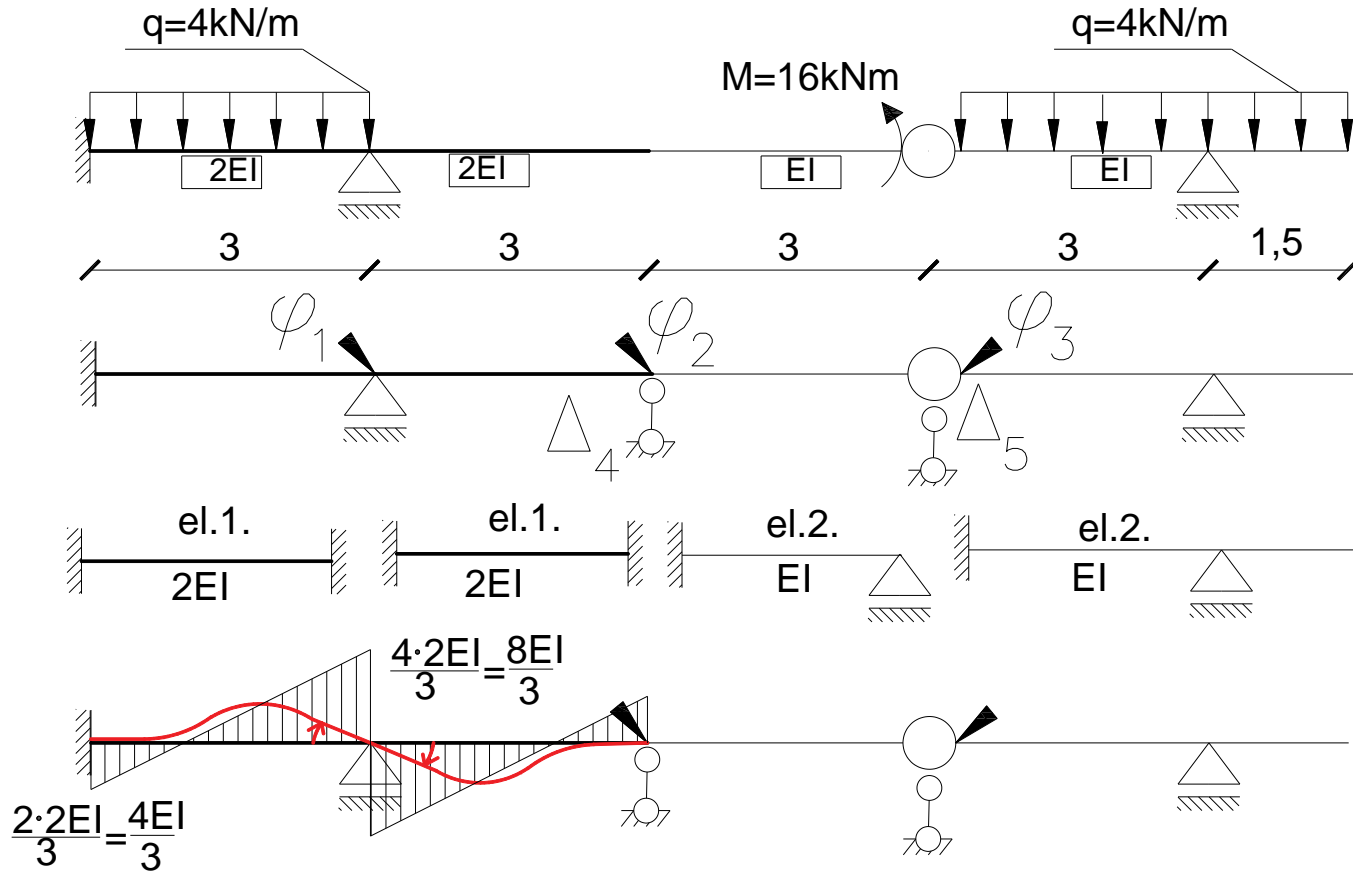

1		$4 \frac{EJ}{l}$	$2 \frac{EJ}{l}$
---	--	------------------	------------------

# Wykresy jednostkowe:

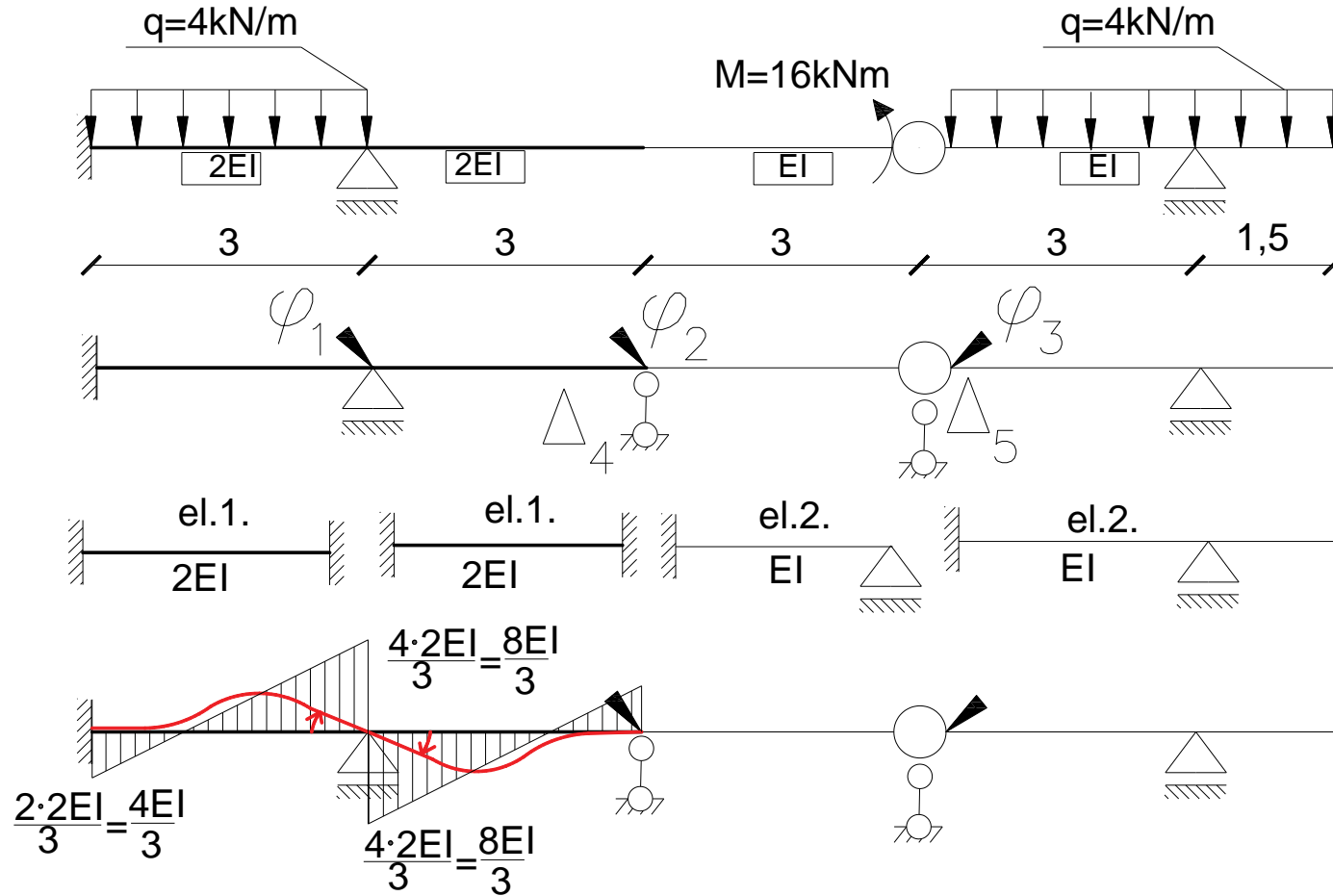

Stan  $\varphi_1=1$

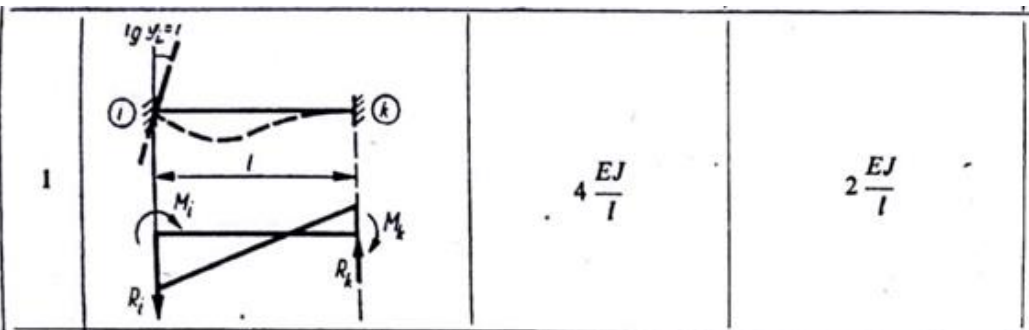



# Wykresy jednostkowe:

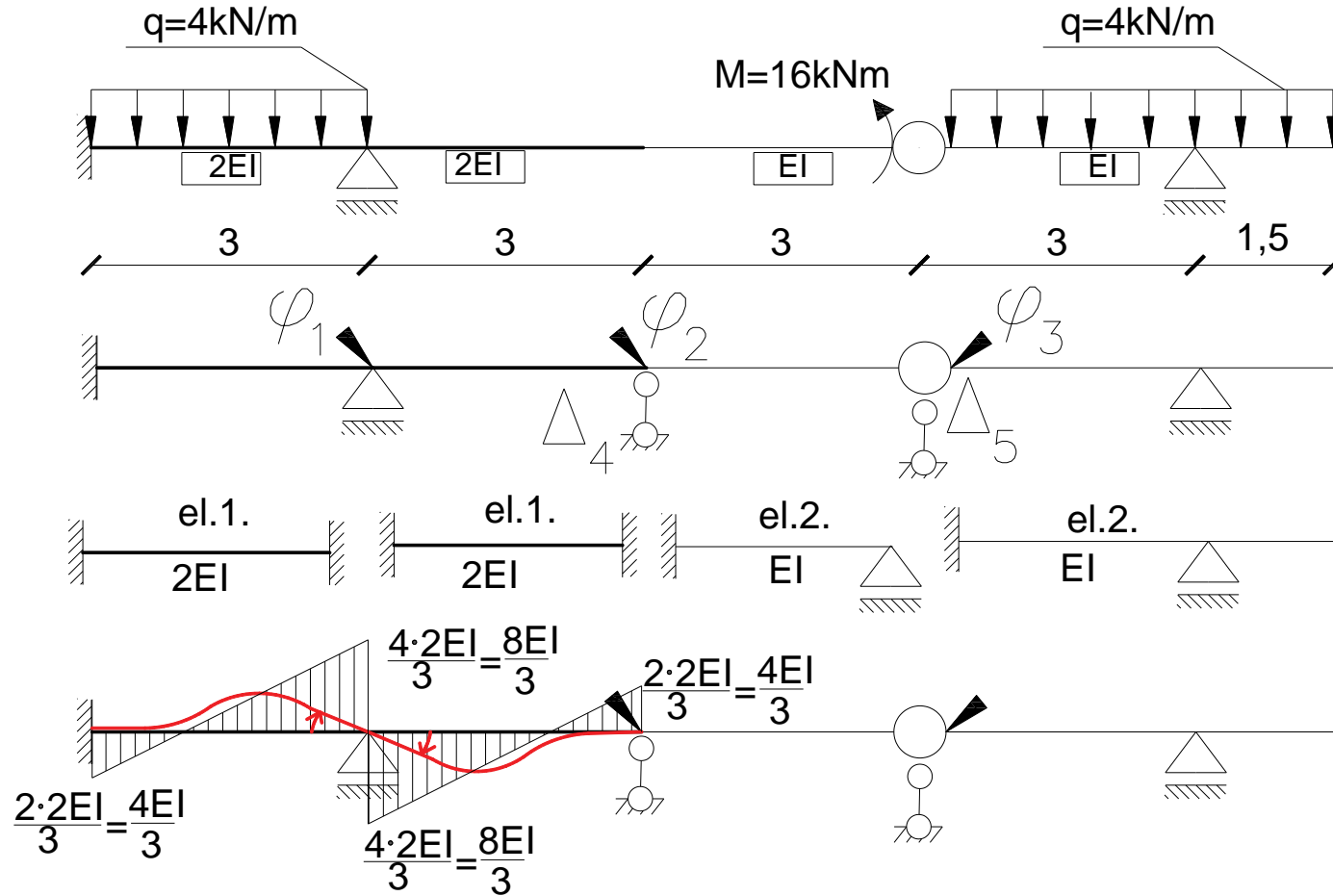

Stan  $\varphi_1=1$

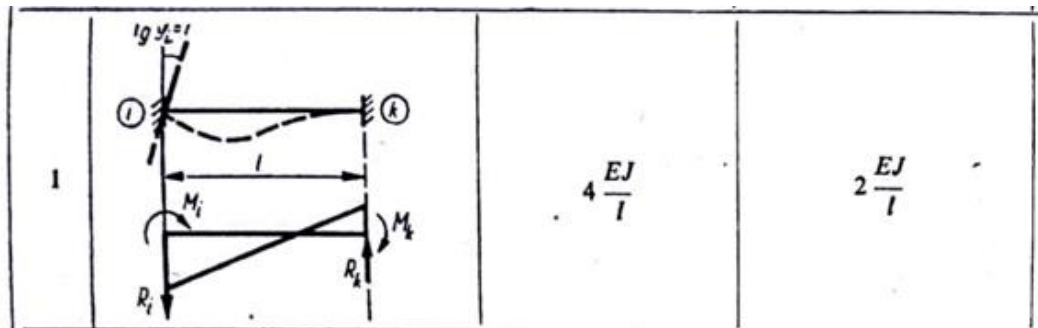

# Wykresy jednostkowe:

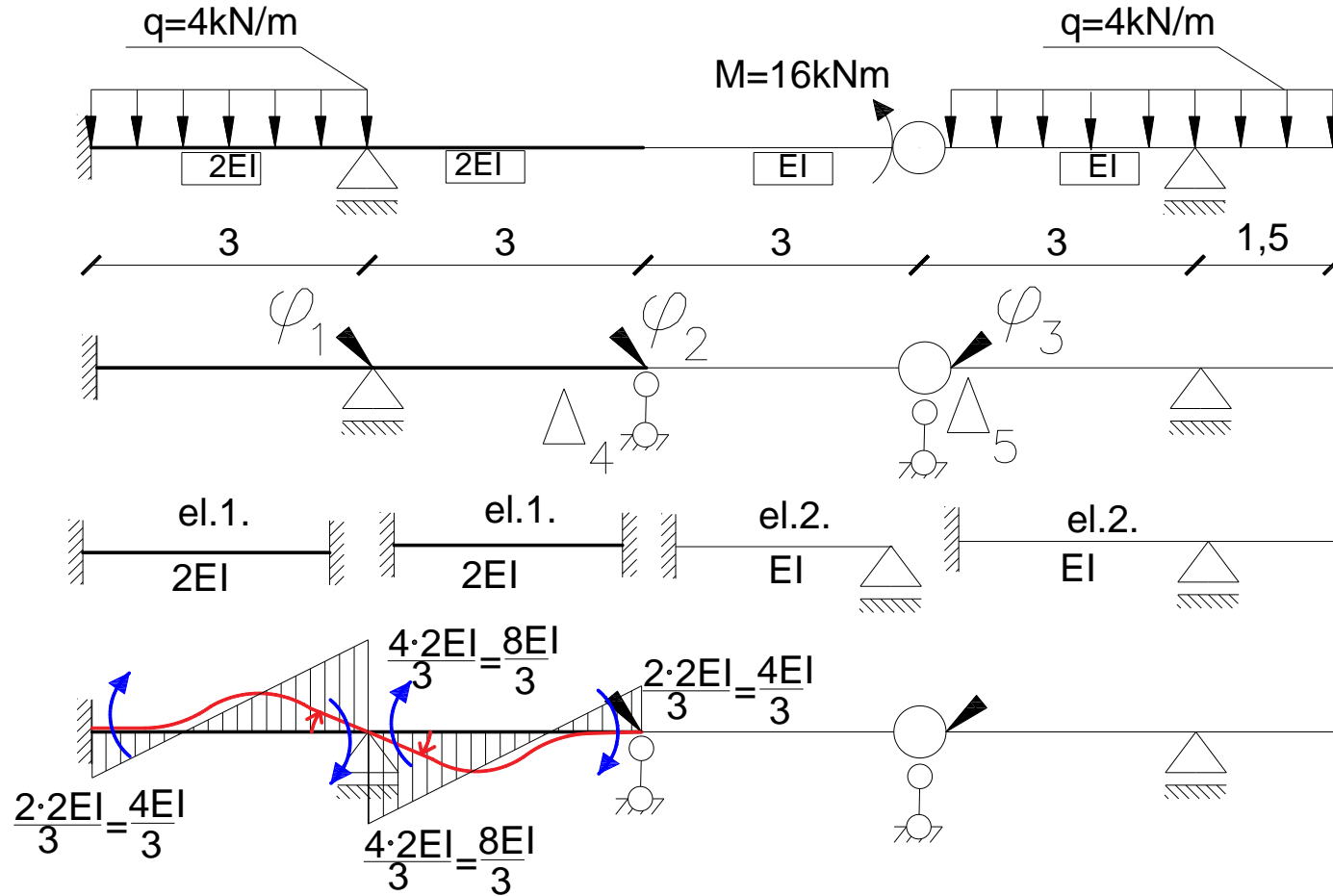

Stan  $\varphi_1=1$

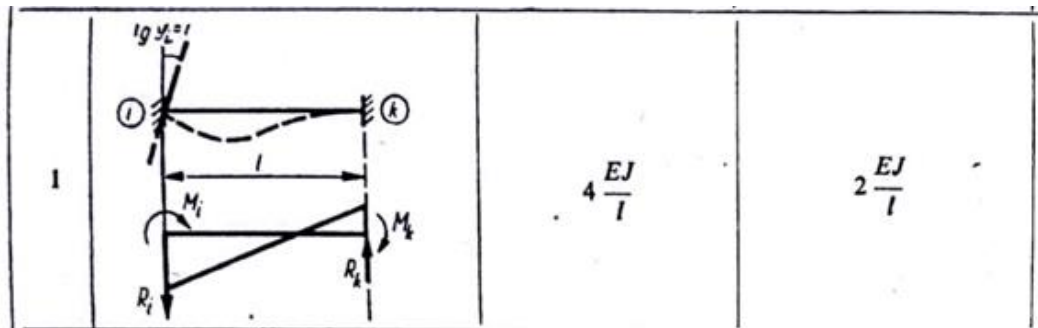

# Wykresy jednostkowe:

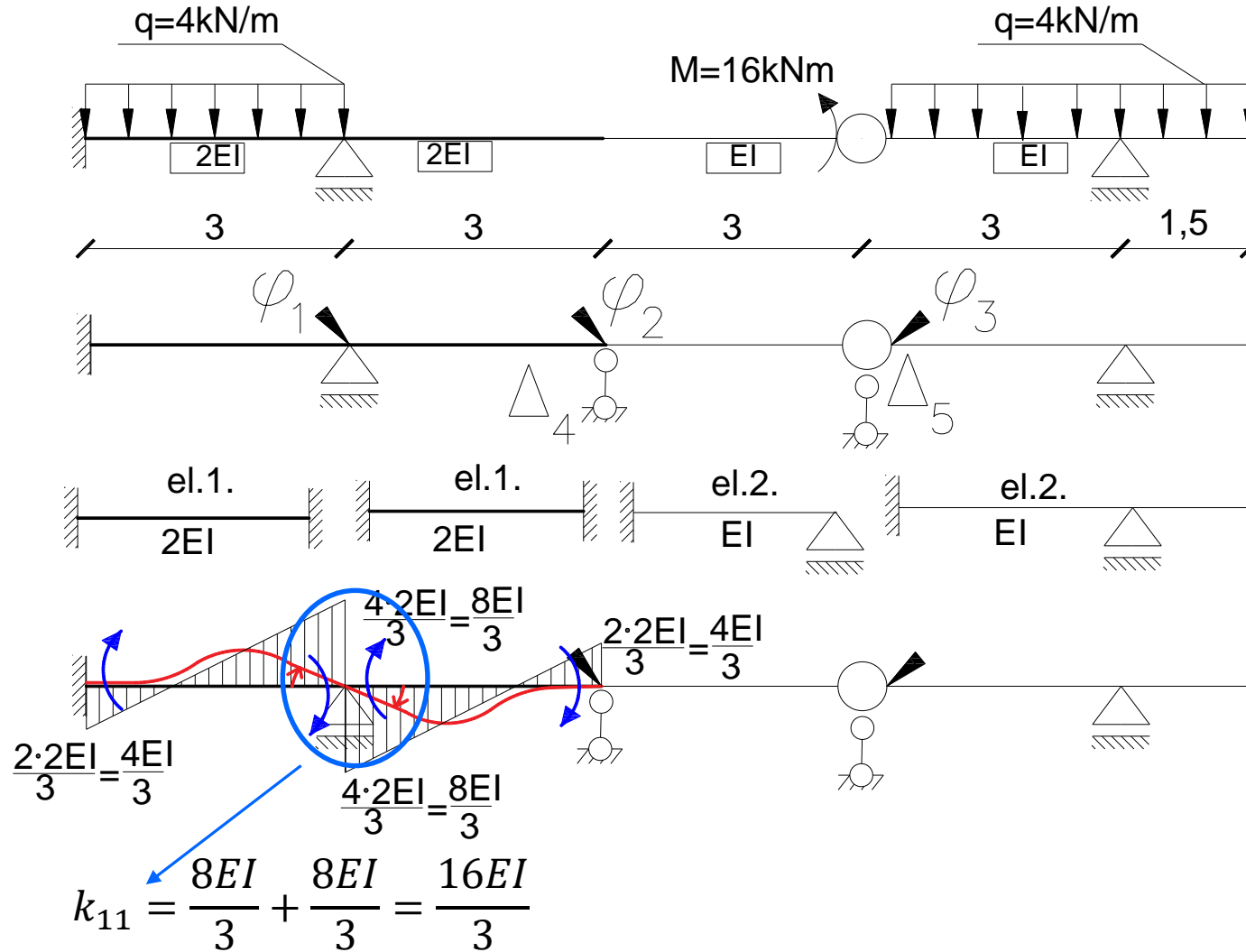

Stan  $\varphi_1=1$

# Wykresy jednostkowe:

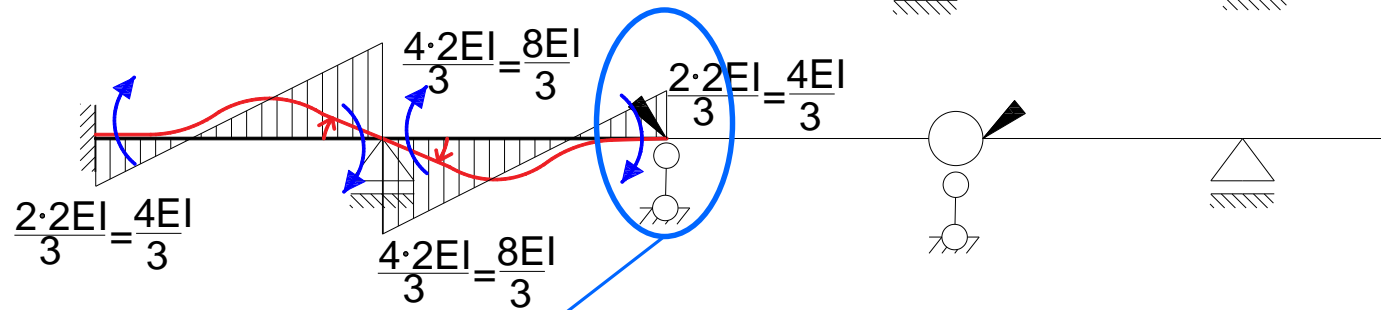
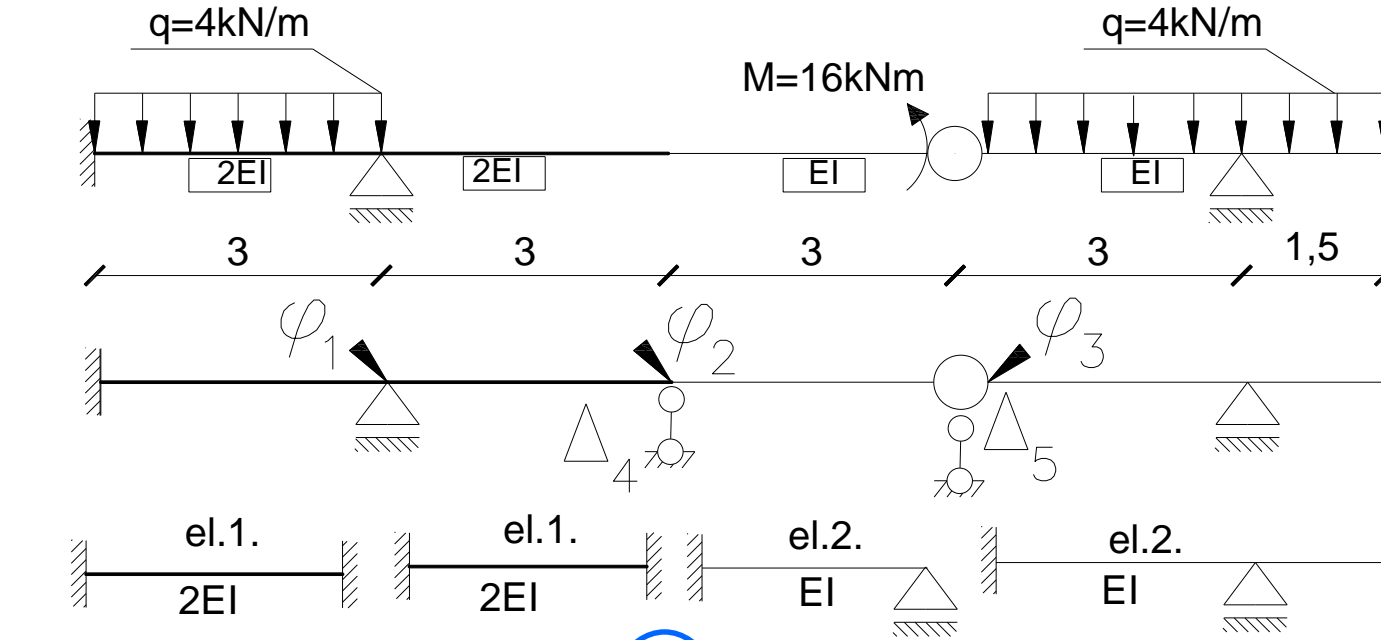

Stan  $\varphi_1=1$

$$k_{11} = \frac{8EI}{3} + \frac{8EI}{3} = \frac{16EI}{3}$$

$$k_{21} = \frac{4EI}{3}$$

# Wykresy jednostkowe:

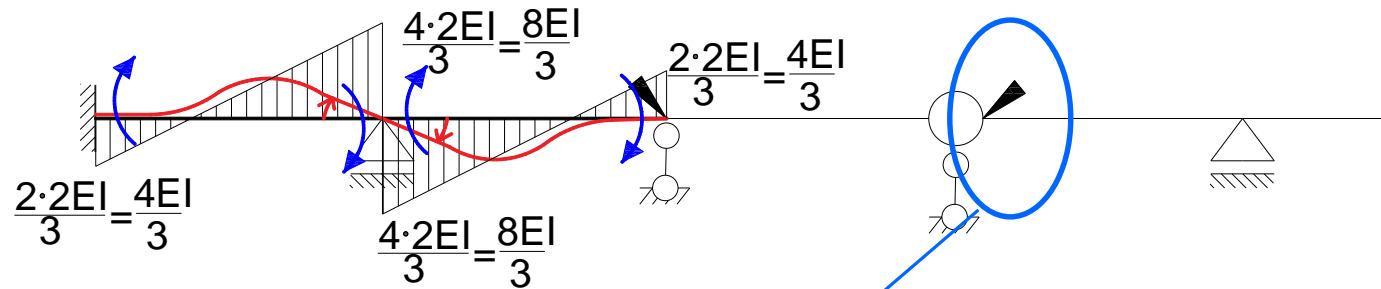
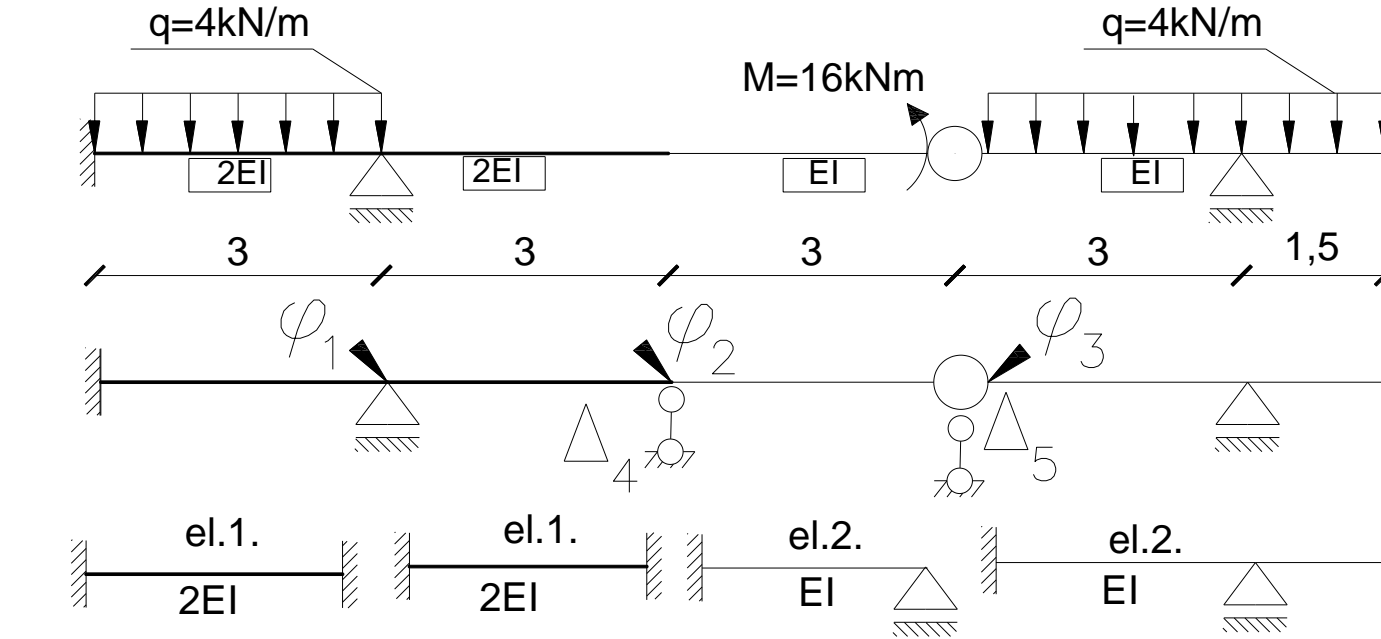

Stan  $\varphi_1=1$

$$k_{11} = \frac{8EI}{3} + \frac{8EI}{3} = \frac{16EI}{3}$$

$$k_{31} = 0$$

$$k_{21} = \frac{4EI}{3}$$

# Wykresy jednostkowe:

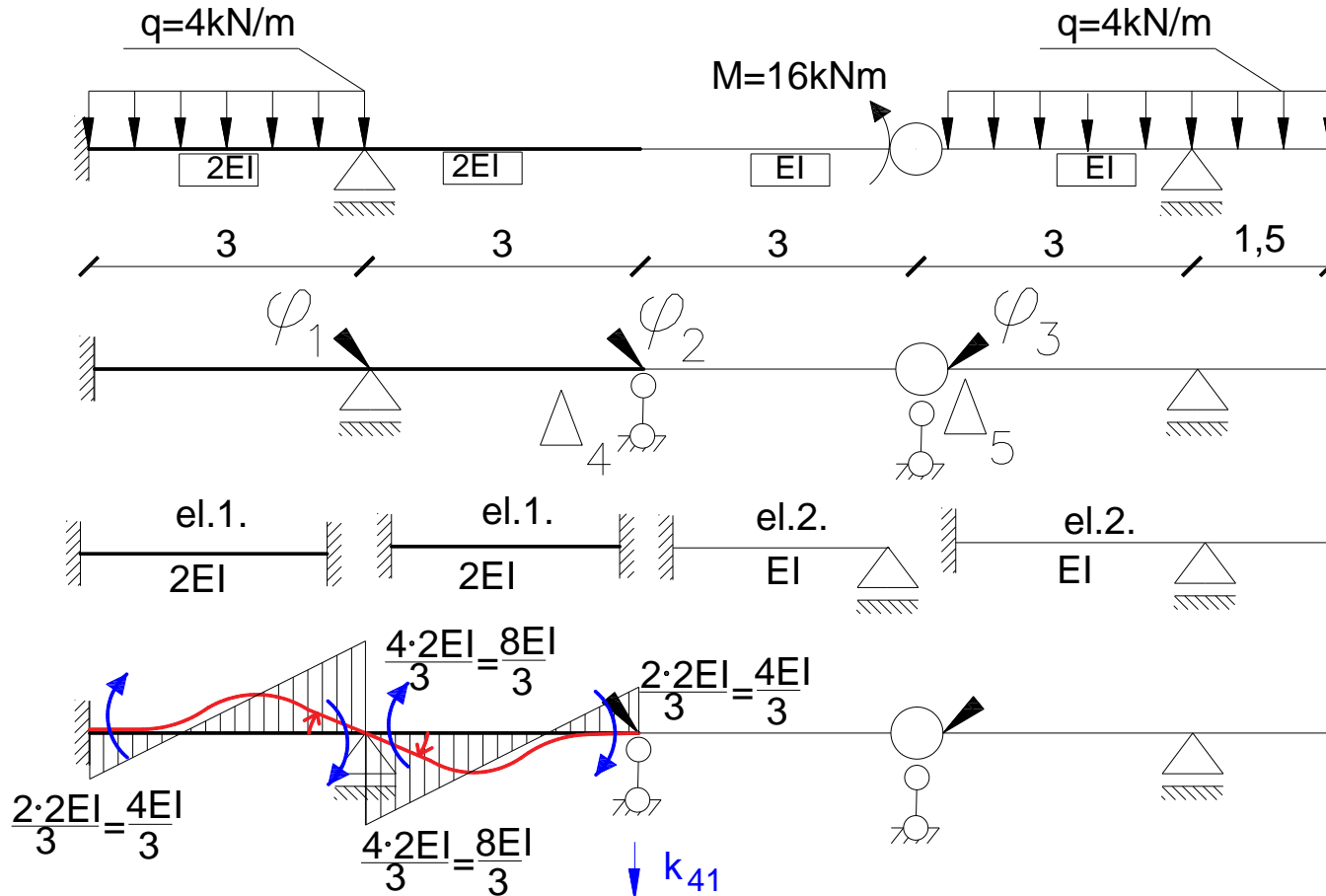

Stan  $\varphi_1=1$

$$k_{11} = \frac{8EI}{3} + \frac{8EI}{3} = \frac{16EI}{3} \quad k_{31} = 0$$

$$k_{21} = \frac{4EI}{3}$$

# Wykresy jednostkowe:

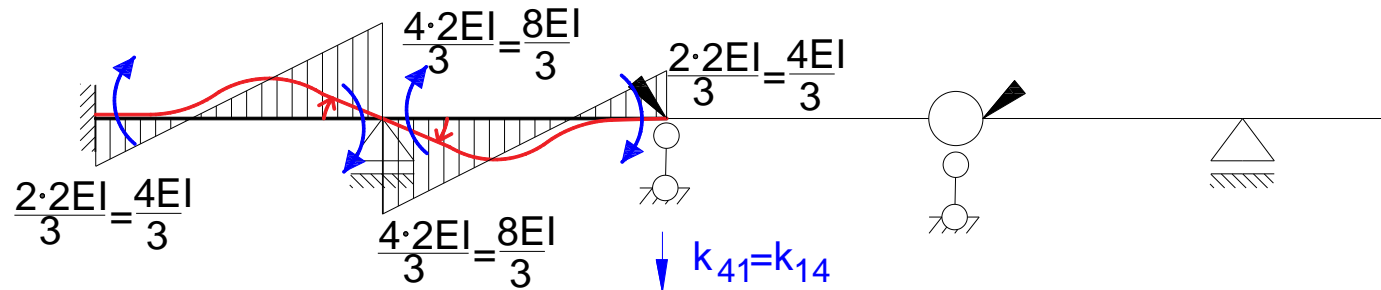
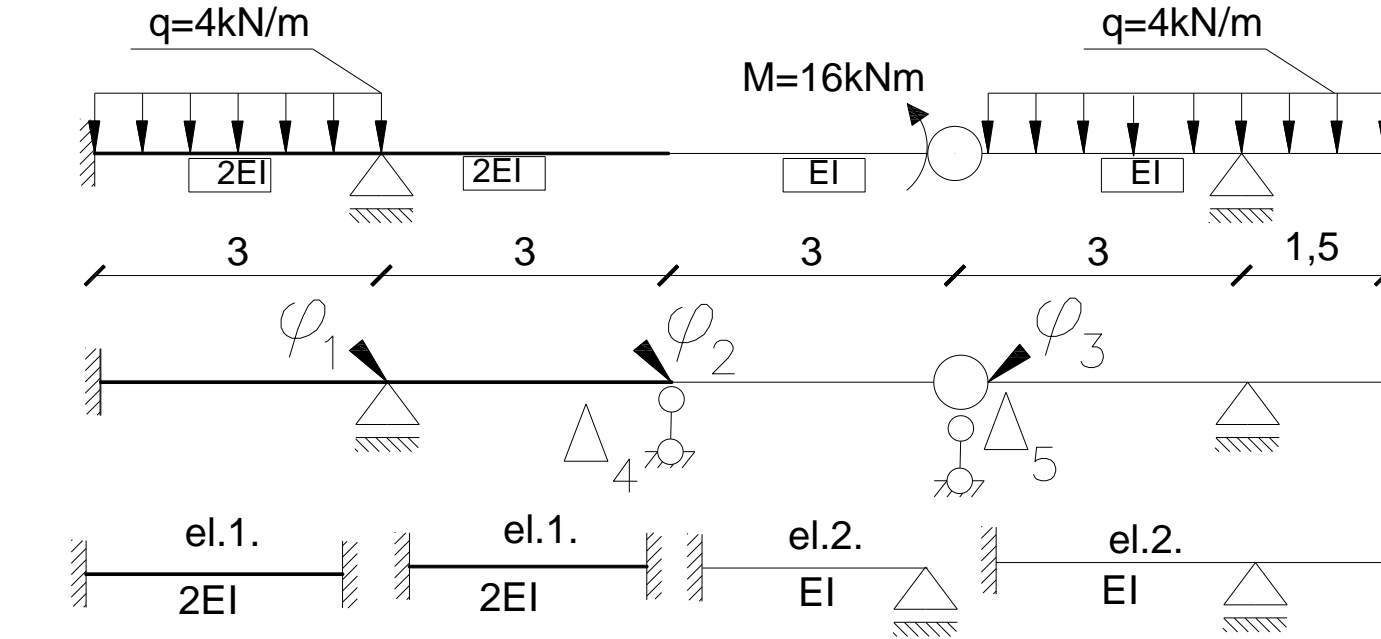

$$k_{11} = \frac{8EI}{3} + \frac{8EI}{3} = \frac{16EI}{3} \quad k_{31} = 0$$

$$k_{21} = \frac{4EI}{3}$$

Stan  $\varphi_1=1$

# Wykresy jednostkowe:

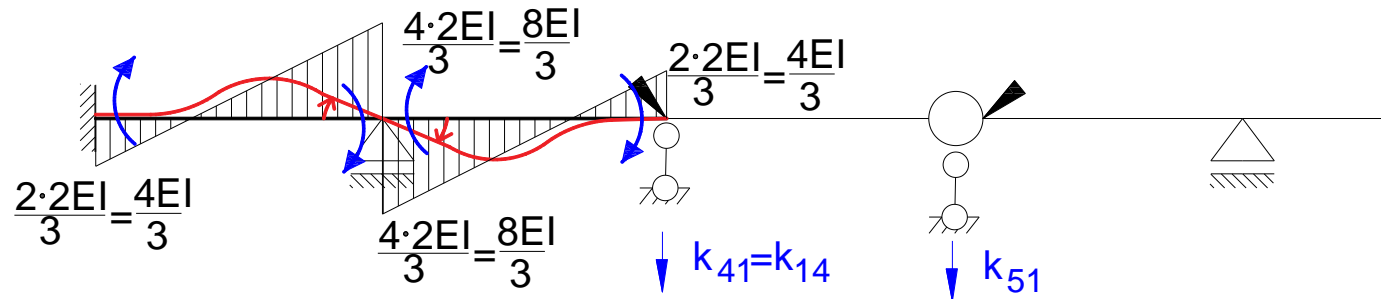
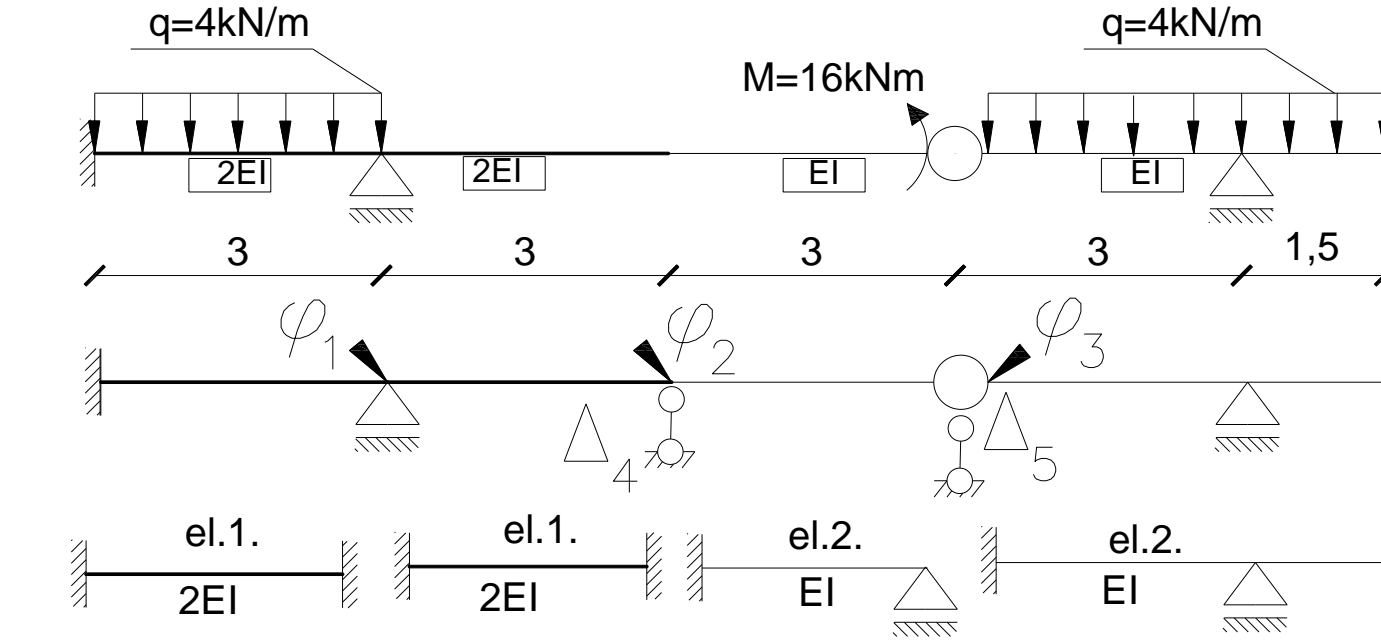

$$k_{11} = \frac{8EI}{3} + \frac{8EI}{3} = \frac{16EI}{3} \quad k_{31} = 0$$

$$k_{21} = \frac{4EI}{3}$$

Stan  $\varphi_1=1$



# Wykresy jednostkowe:

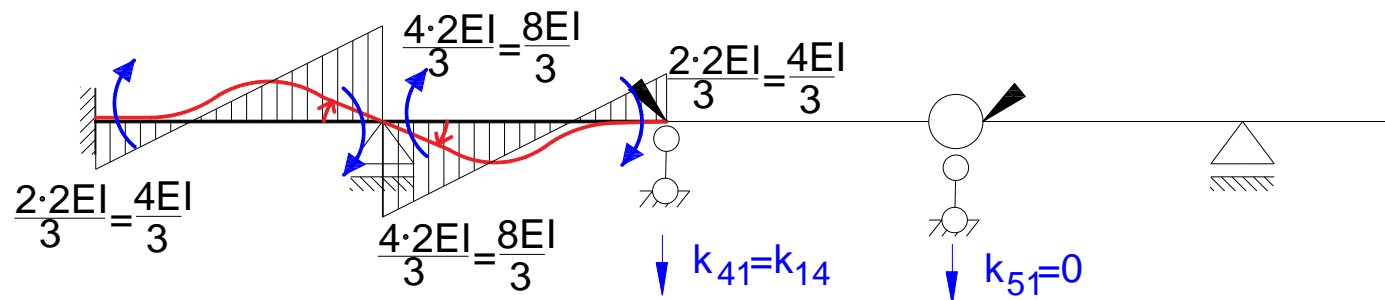
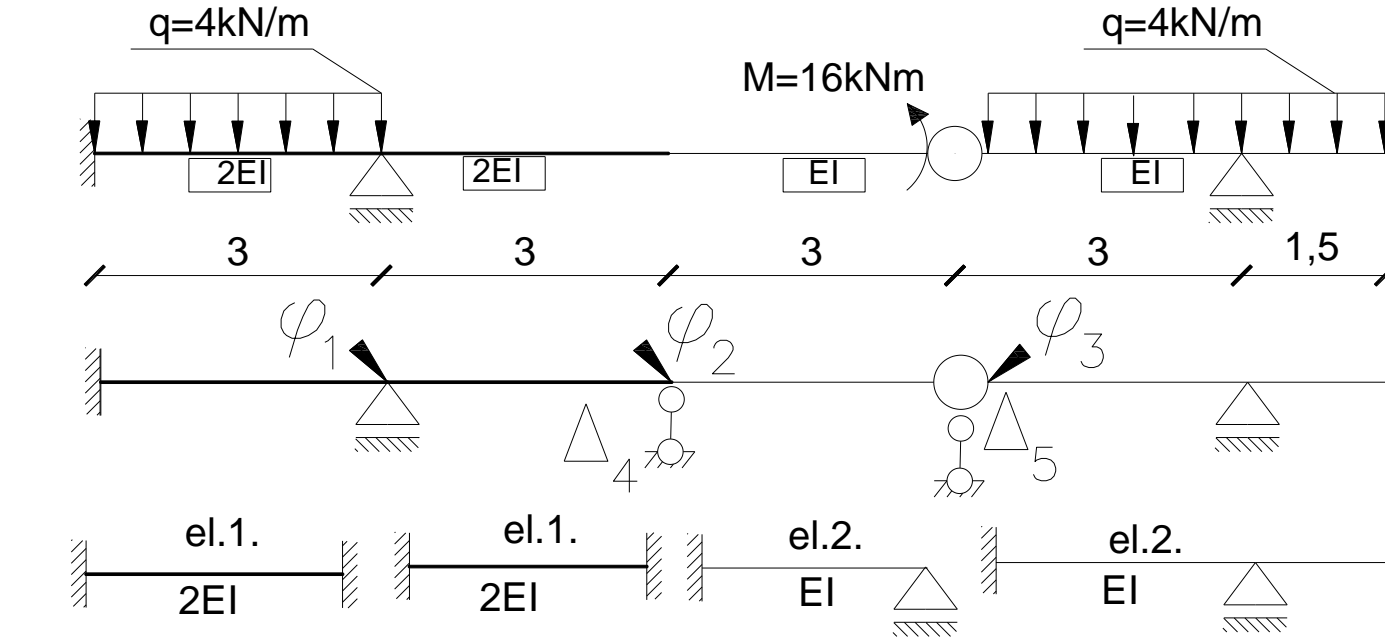

$$k_{11} = \frac{8EI}{3} + \frac{8EI}{3} = \frac{16EI}{3}$$

$$k_{21} = \frac{4EI}{3}$$

$$k_{31} = 0$$

Stan  $\varphi_1=1$

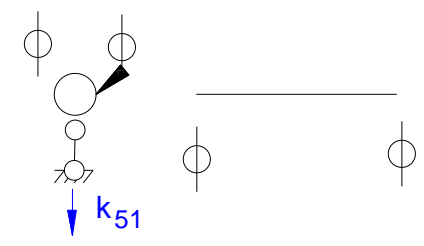

# Wykresy jednostkowe:

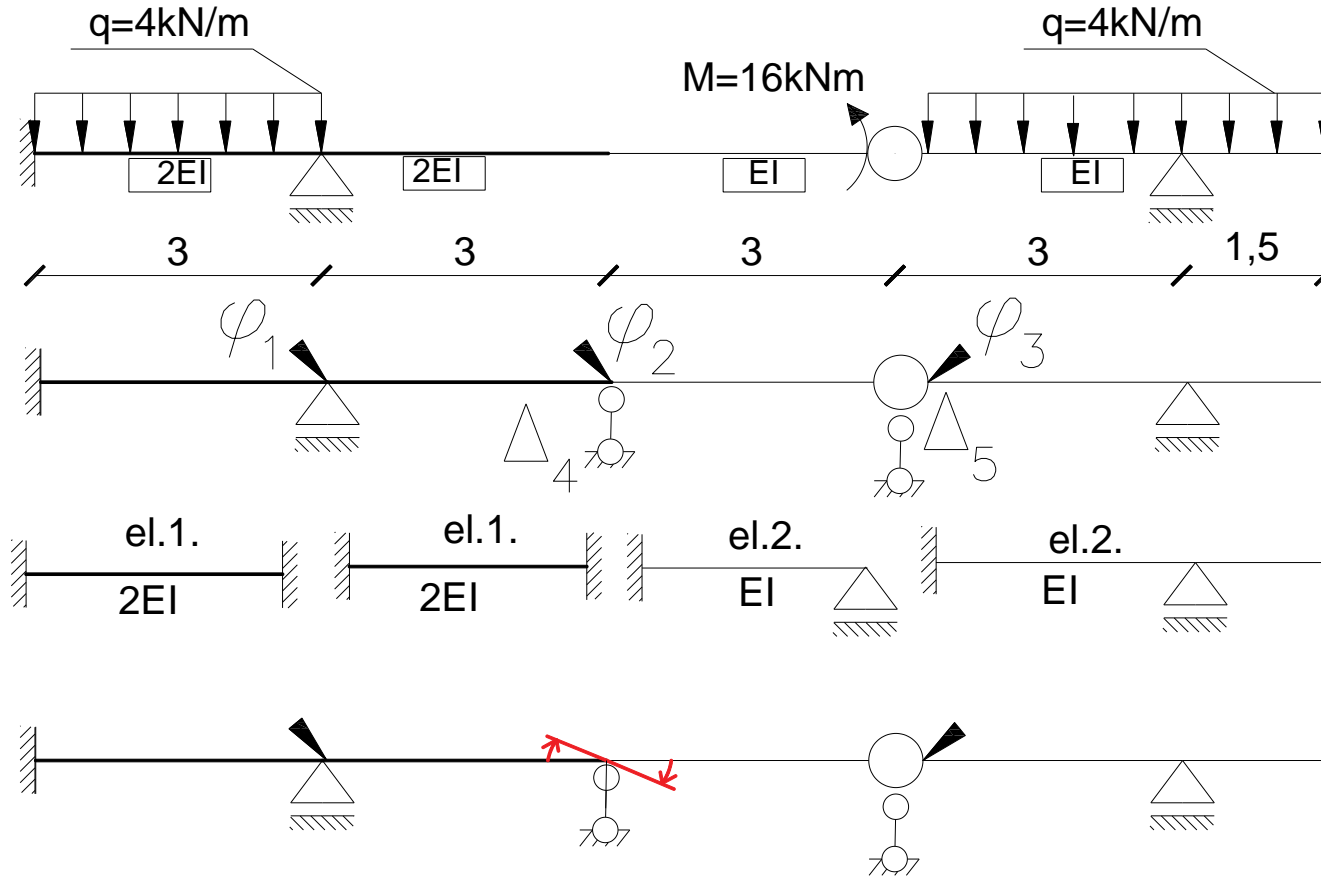

# Wykresy jednostkowe:

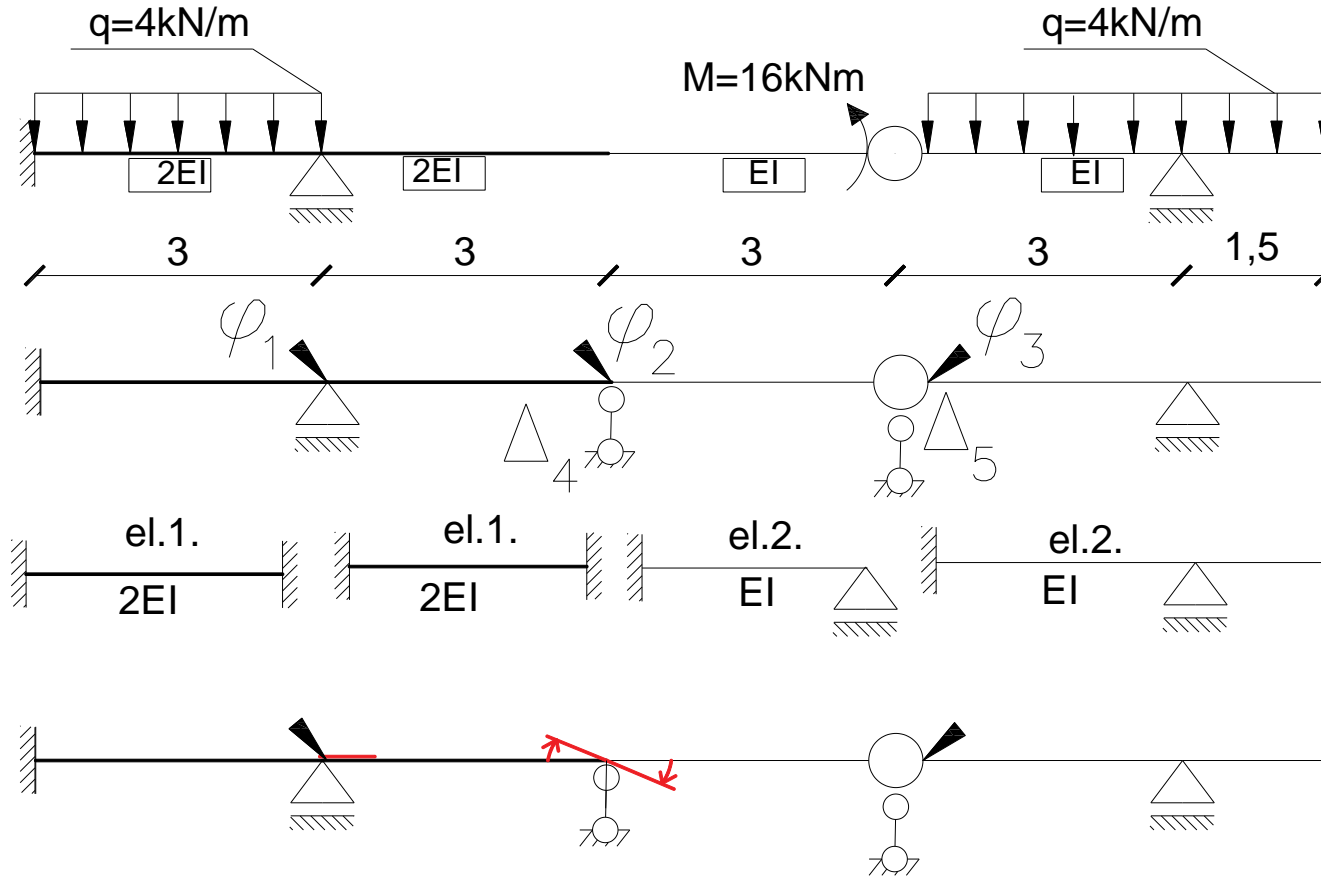

Stan  $\varphi_2=1$

# Wykresy jednostkowe:

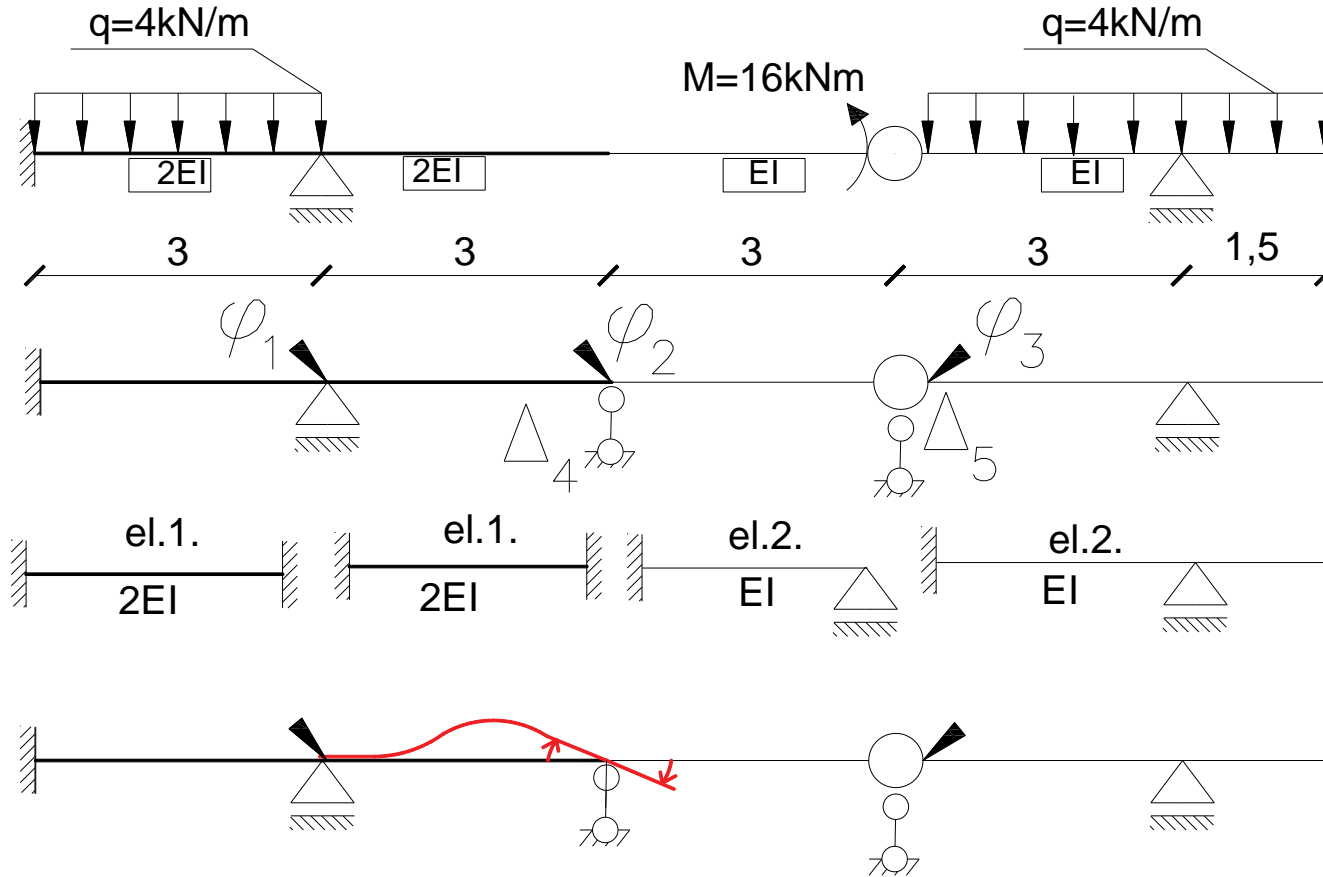

Stan  $\varphi_2=1$

# Wykresy jednostkowe:

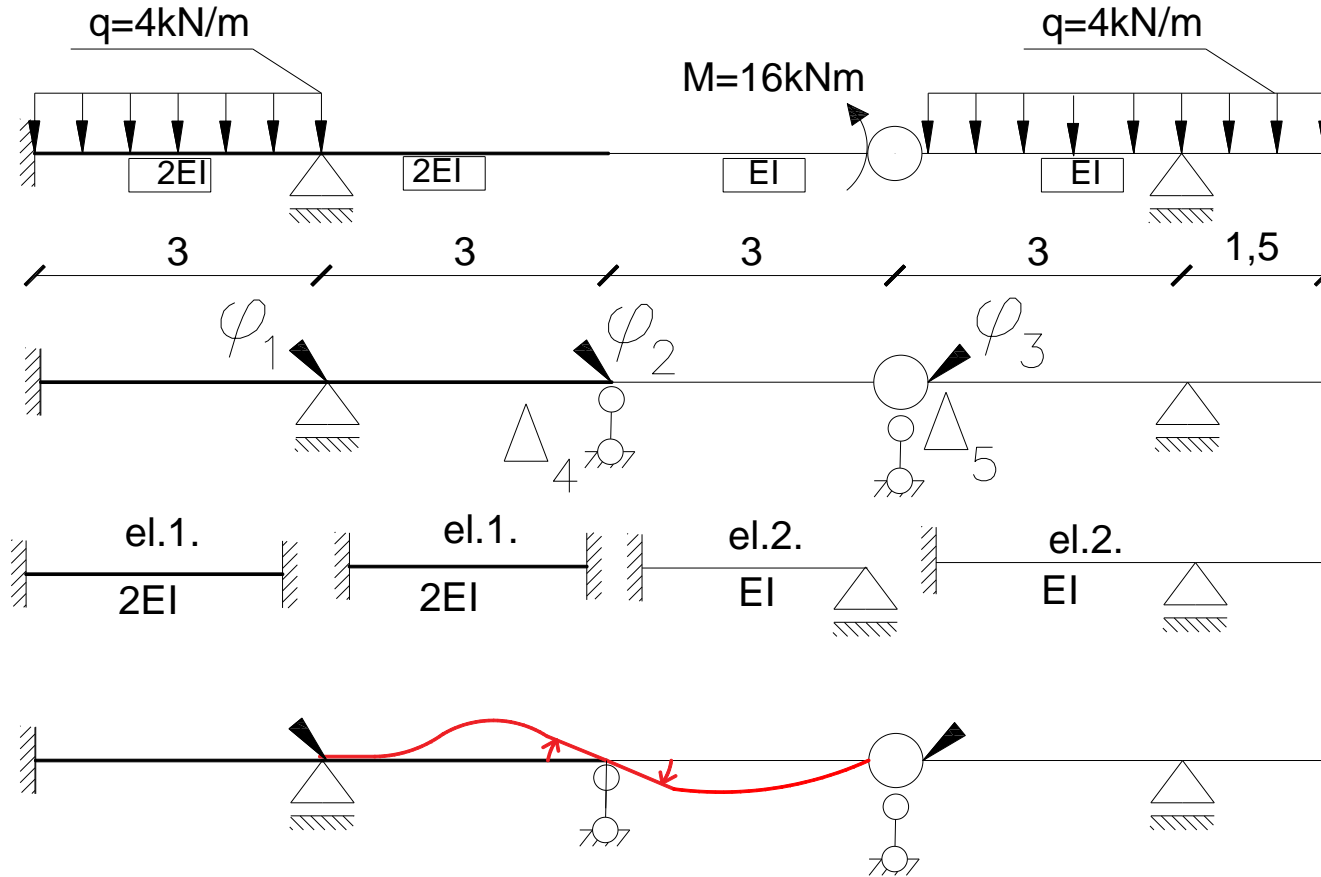

Stan  $\varphi_2=1$

# Wykresy jednostkowe:

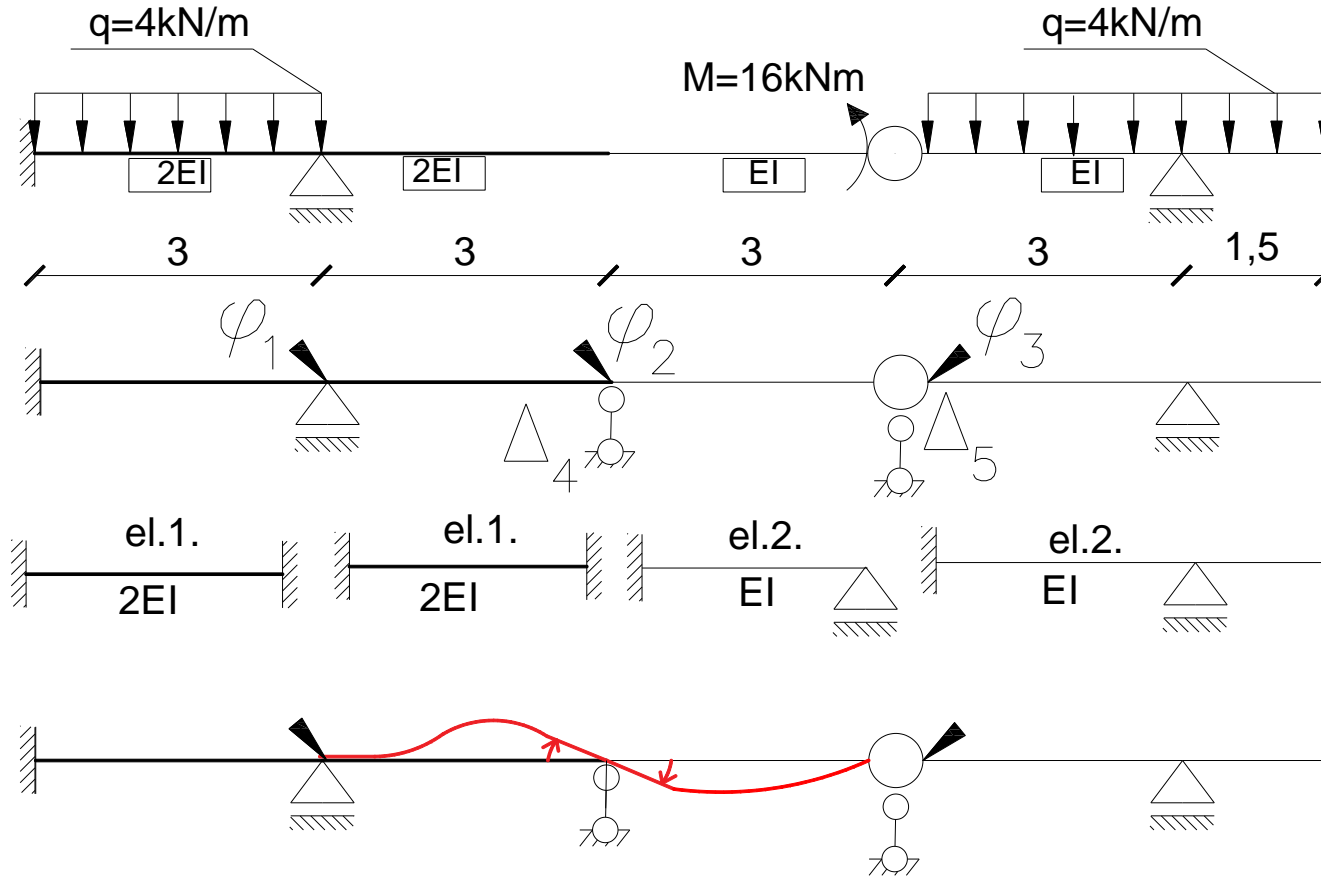

Stan  $\varphi_2=1$

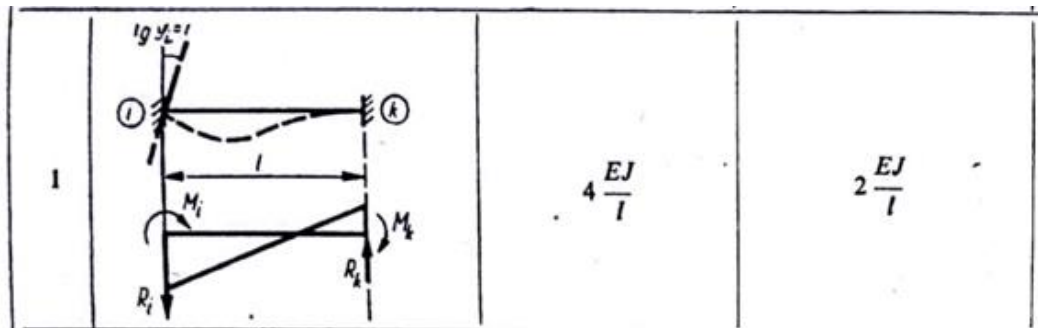

# Wykresy jednostkowe:

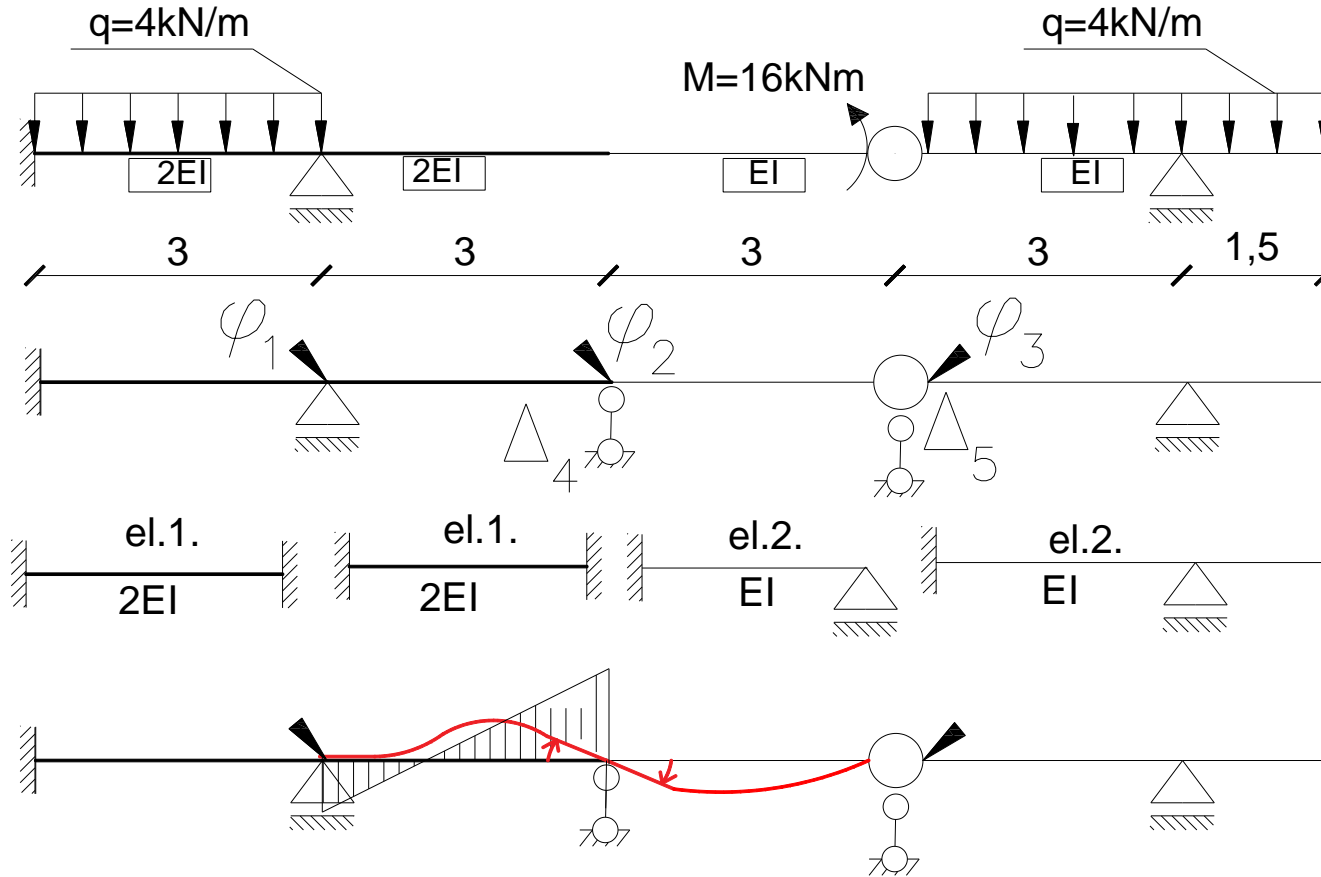

Stan  $\varphi_2=1$

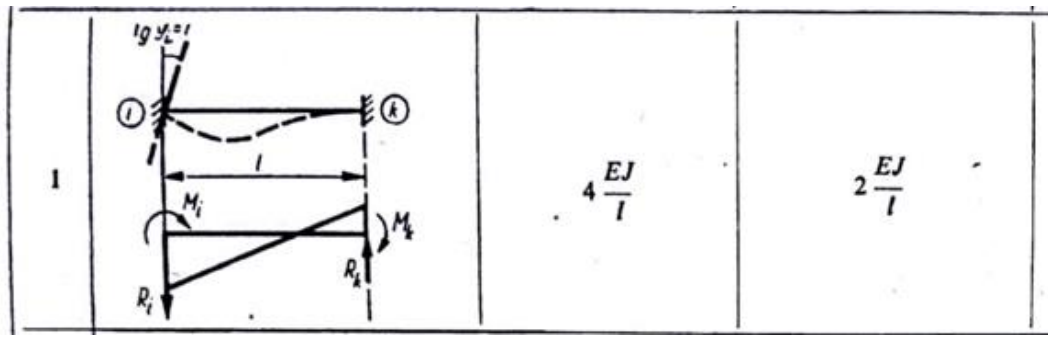

# Wykresy jednostkowe:

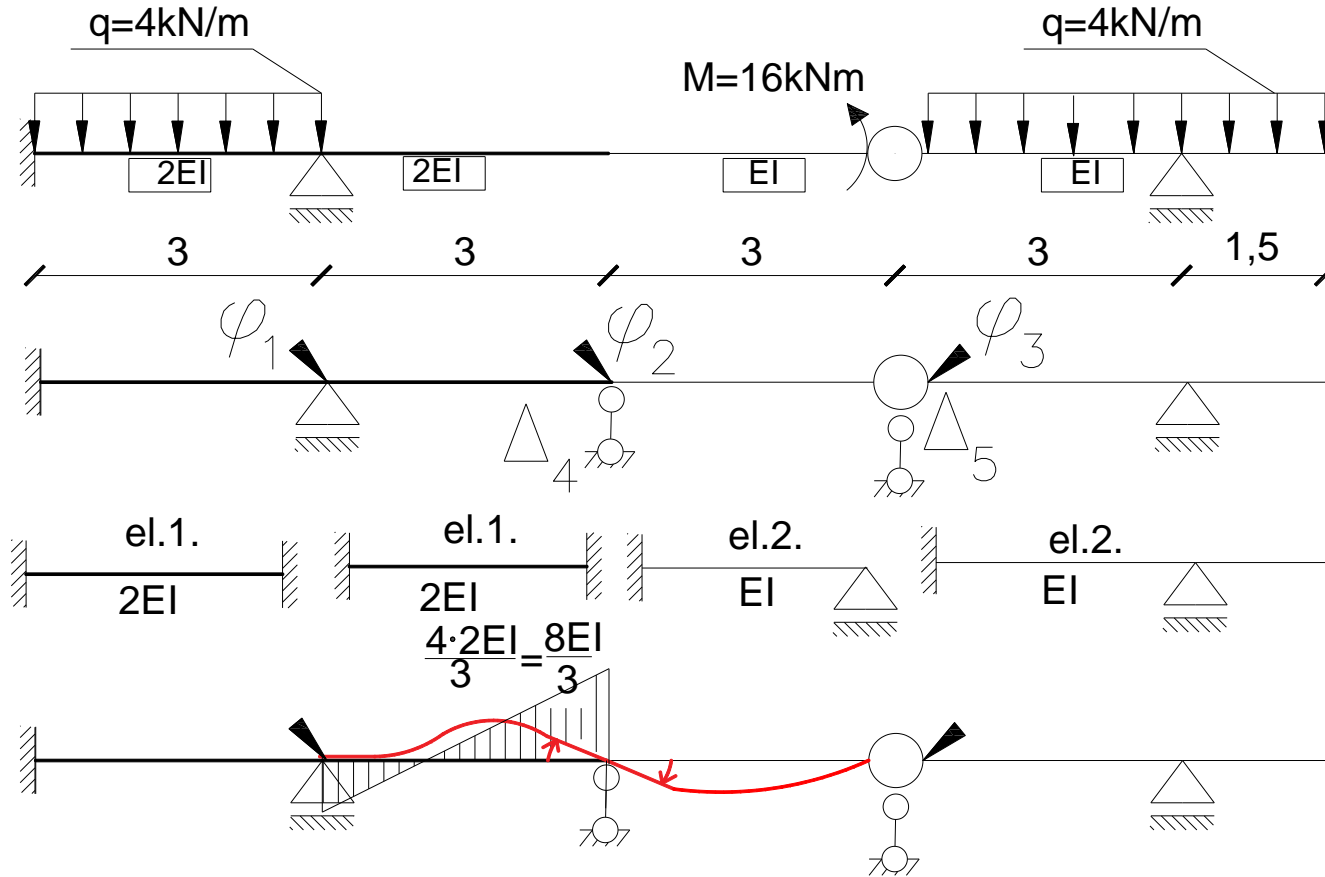

Stan  $\varphi_2=1$

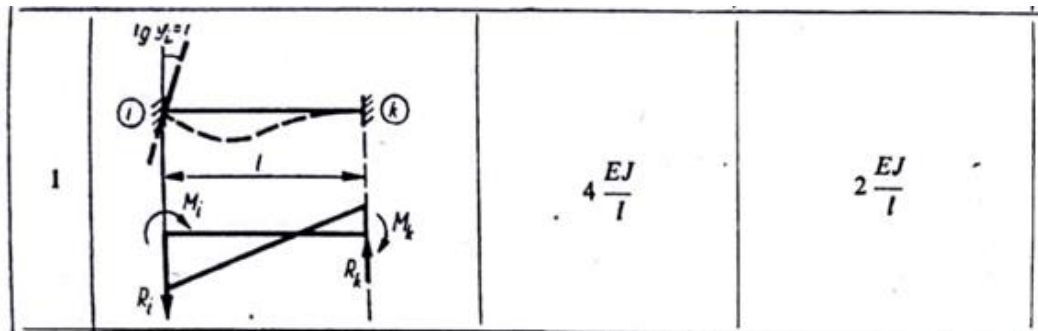



# Wykresy jednostkowe:

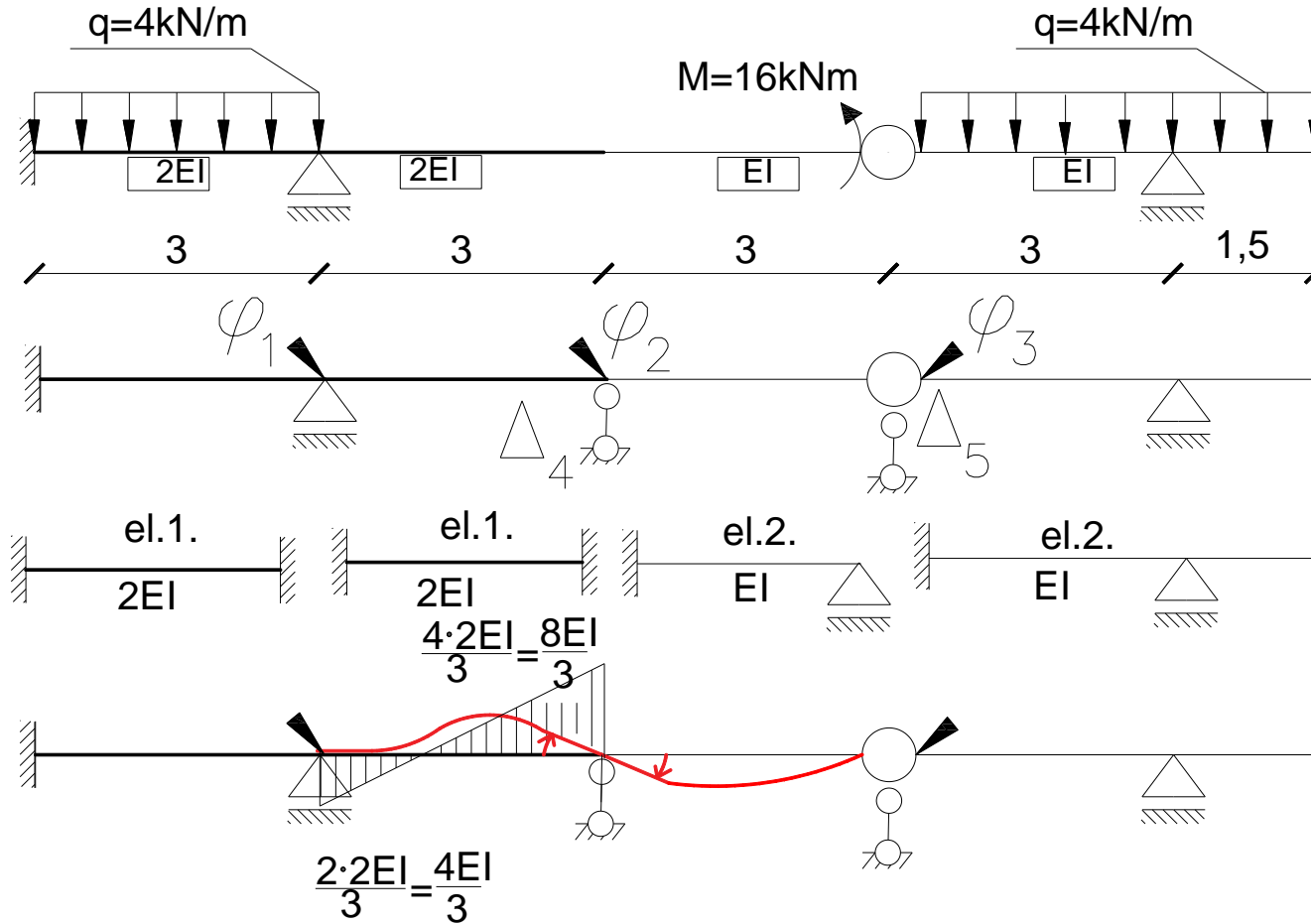

Stan  $\varphi_2=1$

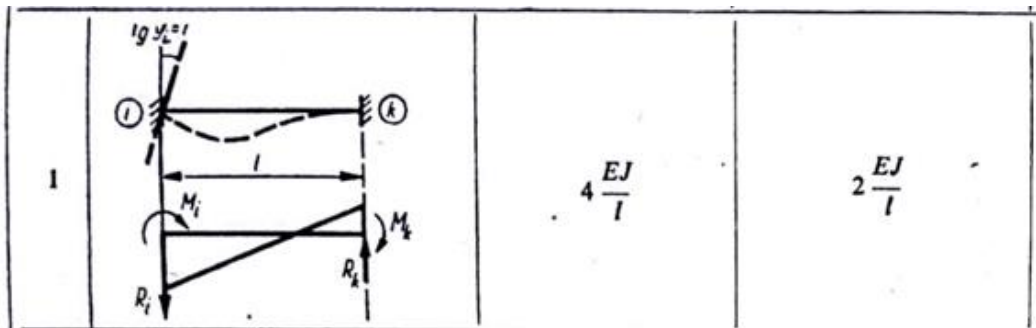

# Wykresy jednostkowe:

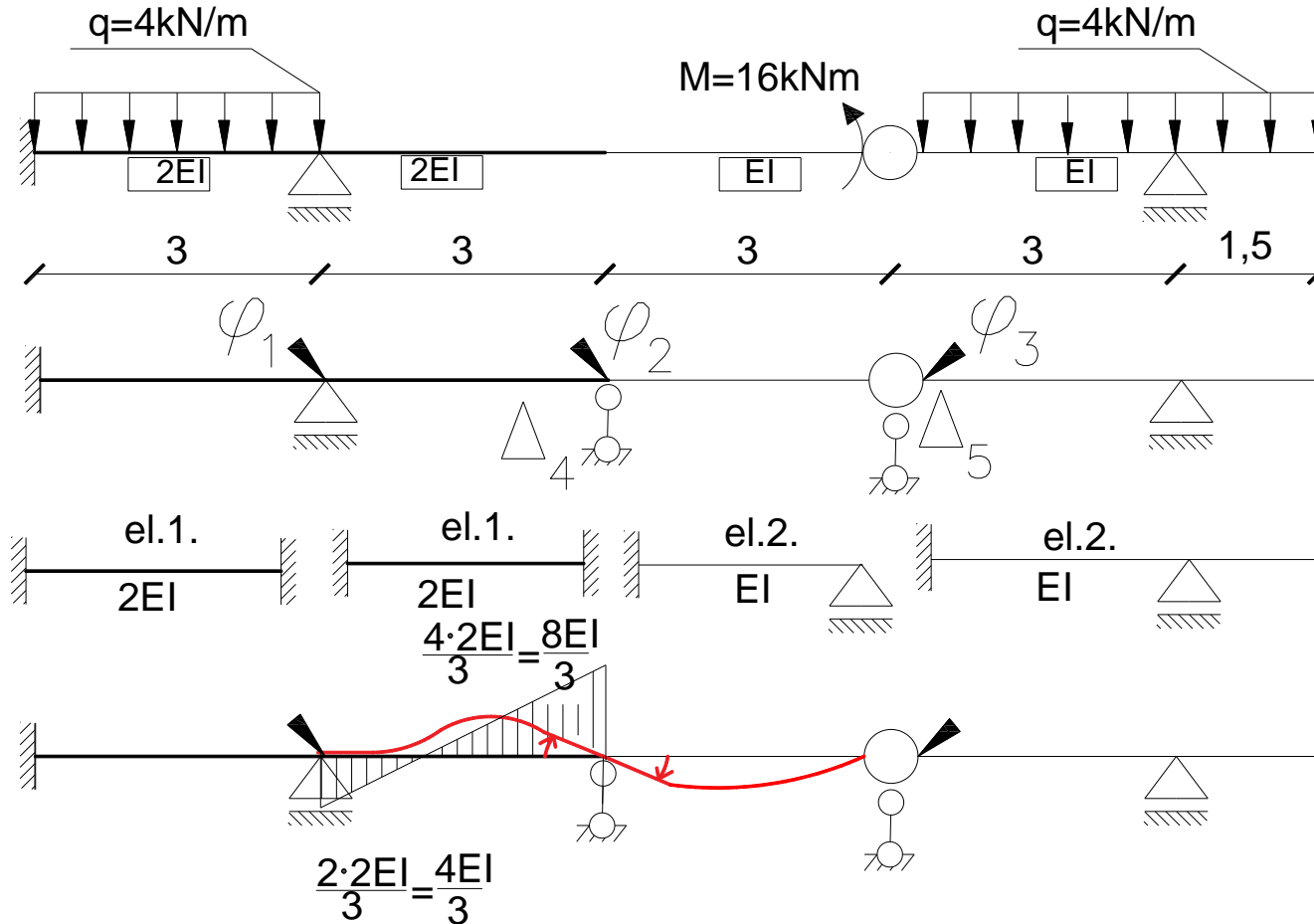

Stan  $\varphi_2=1$

	1	2	3	4
22		$\frac{3EJ}{l}$	0	

# Wykresy jednostkowe:

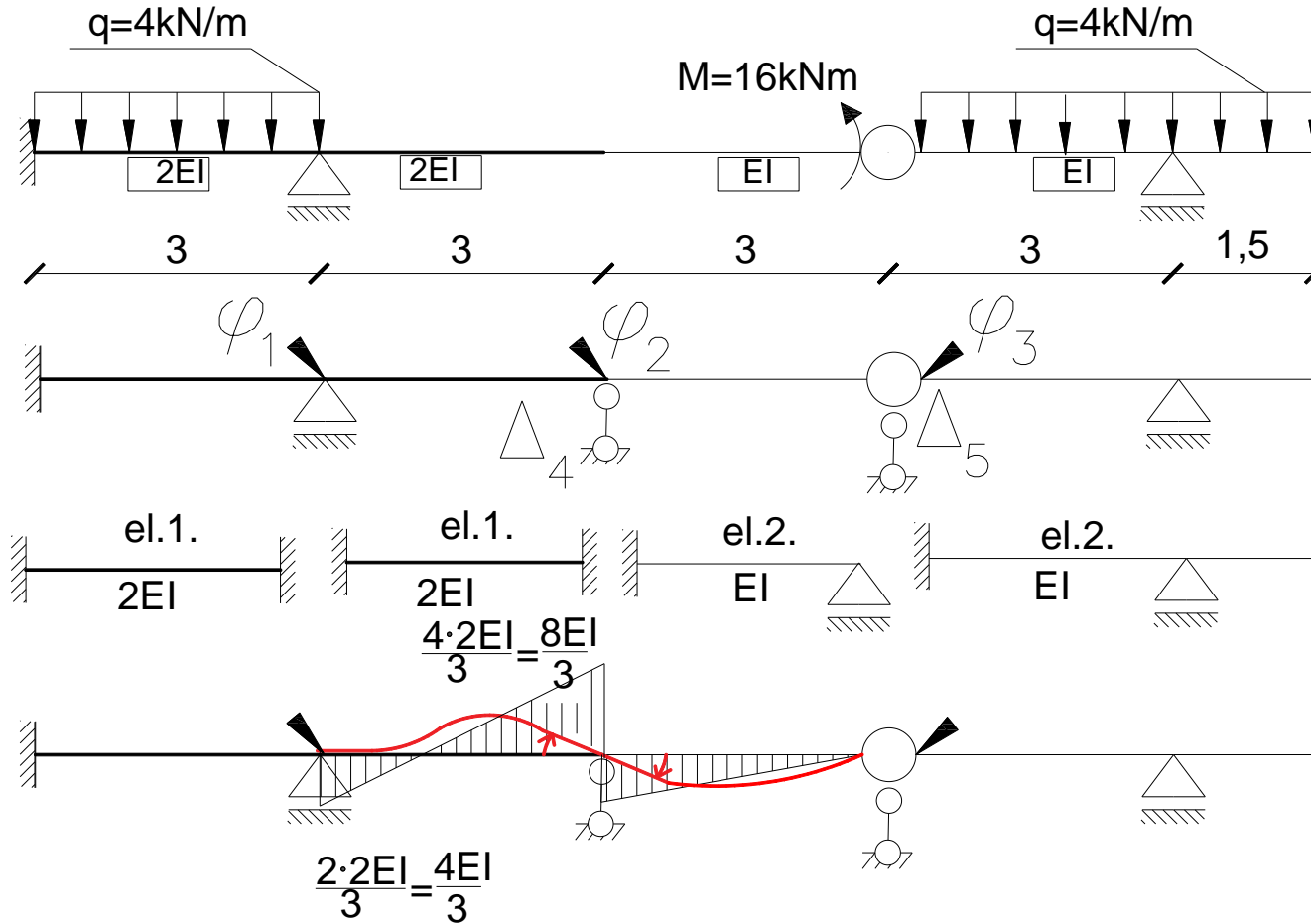

Stan  $\varphi_2=1$

	1	2	3	4
22			$3 \frac{EJ}{l}$	0

# Wykresy jednostkowe:

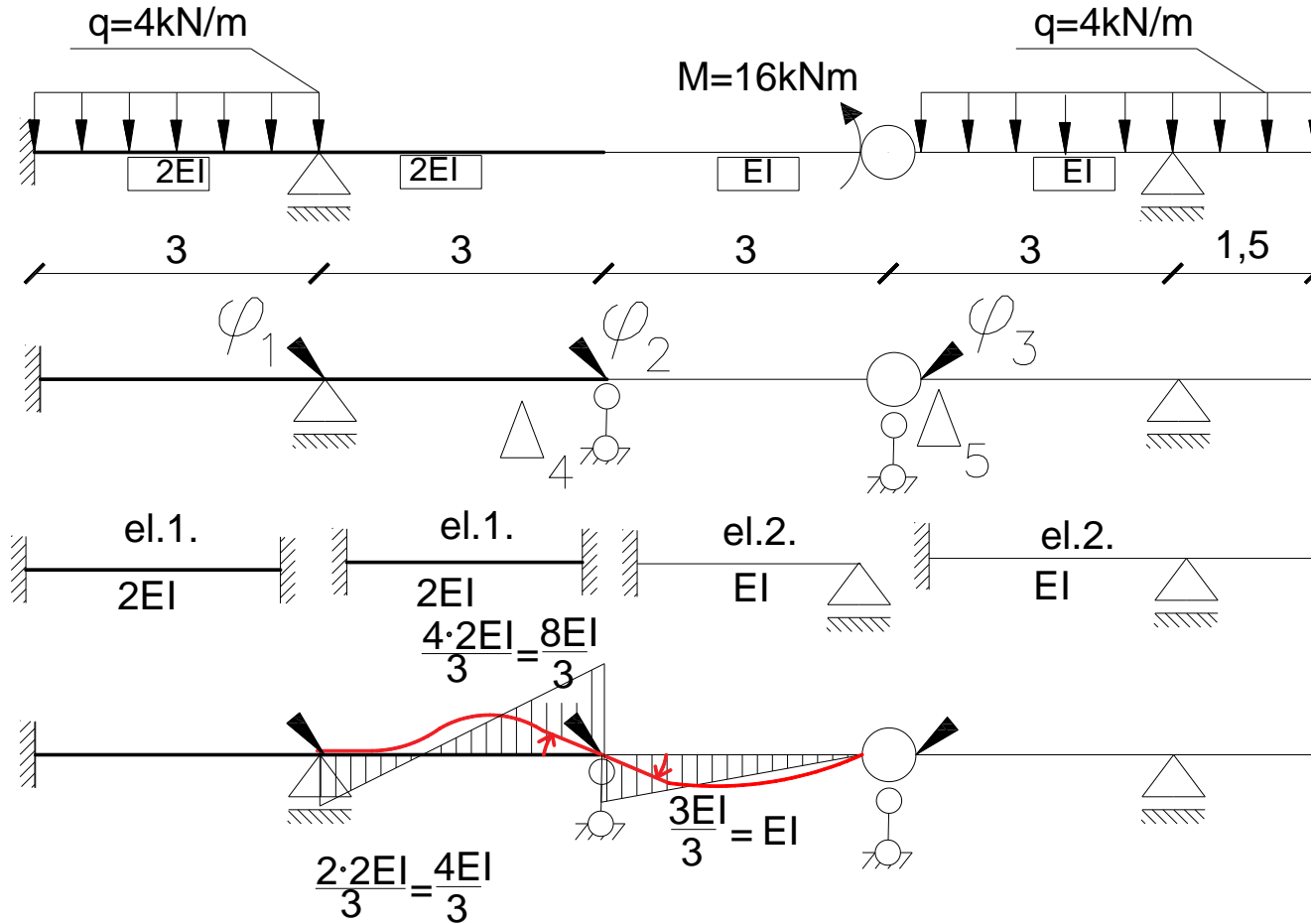

Stan  $\varphi_2=1$

	1	2	3	4
22		$\frac{3EJ}{l}$	$0$	

# Wykresy jednostkowe:

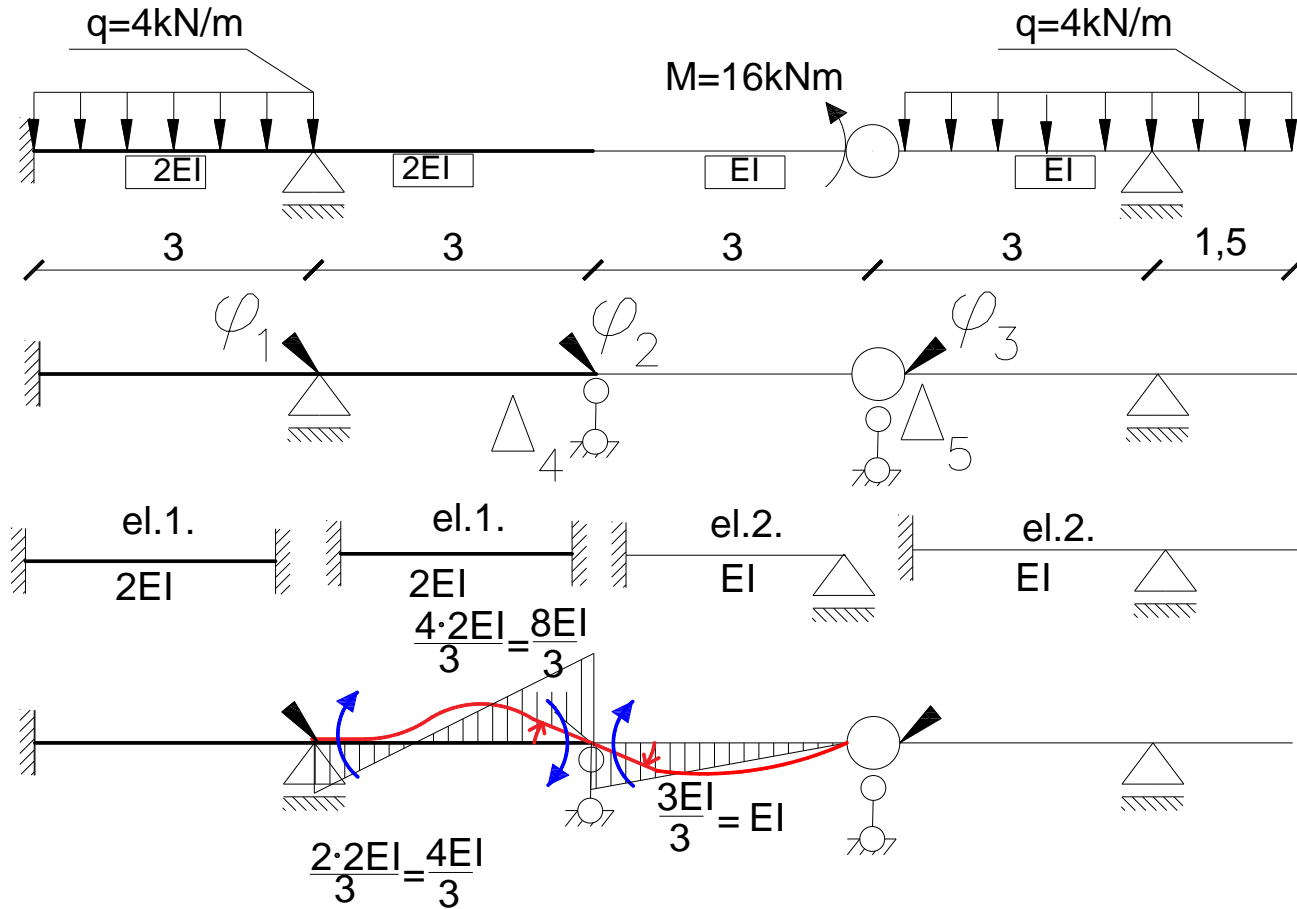

Stan  $\varphi_2=1$

# Wykresy jednostkowe:

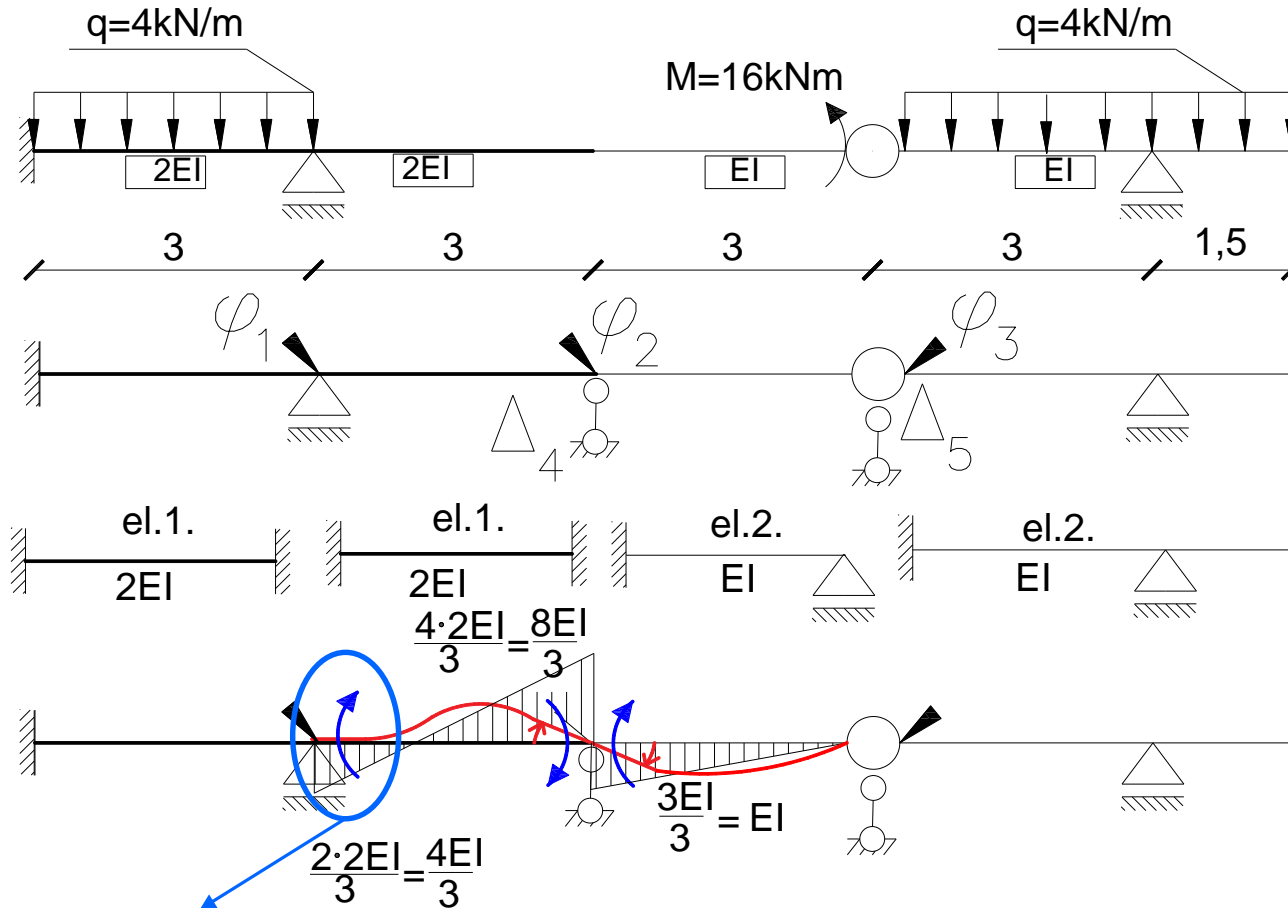

Stan  $\varphi_2=1$

$$k_{12} = \frac{4EI}{3}$$

# Wykresy jednostkowe:

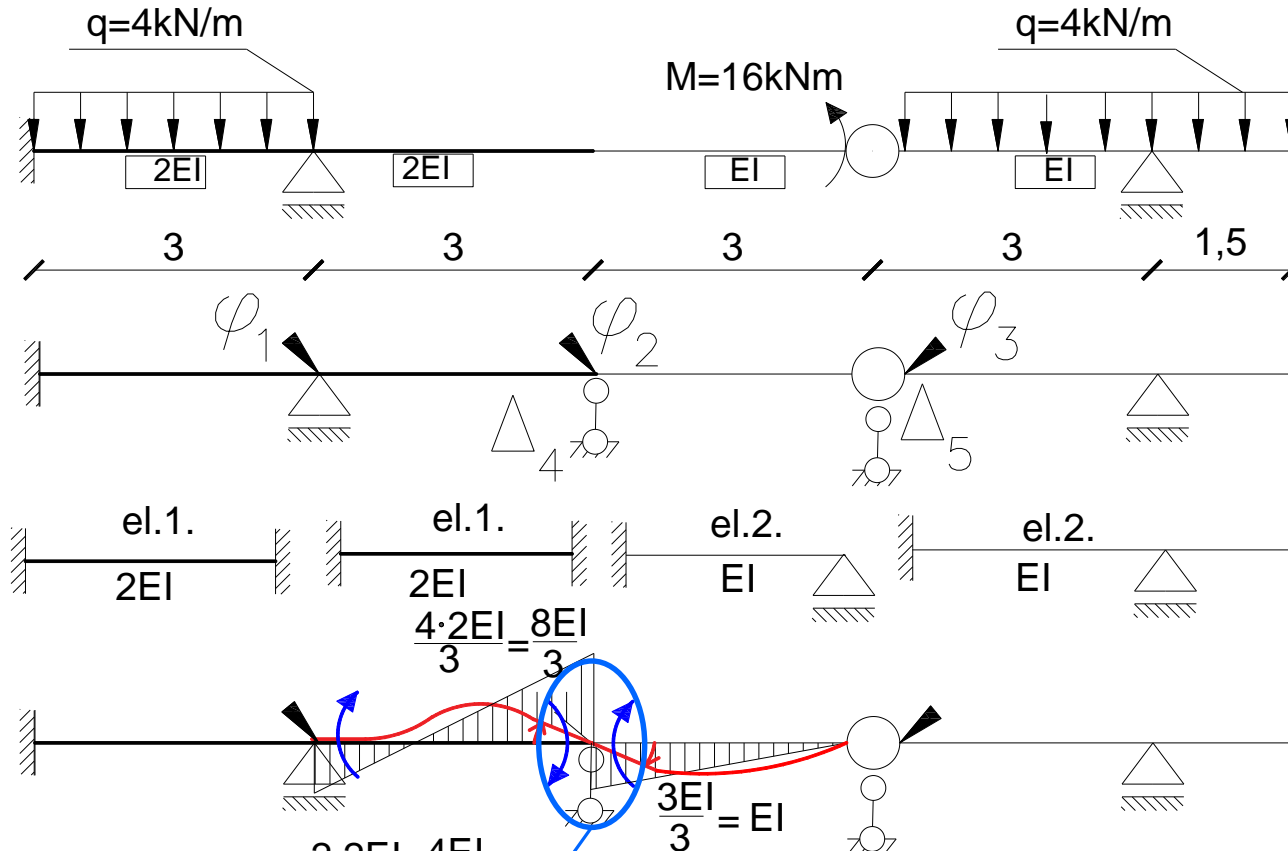

Stan  $\varphi_2=1$

$$k_{12} = \frac{4EI}{3}$$

$$k_{22} = \frac{8EI}{3} + EI = \frac{11EI}{3}$$

# Wykresy jednostkowe:

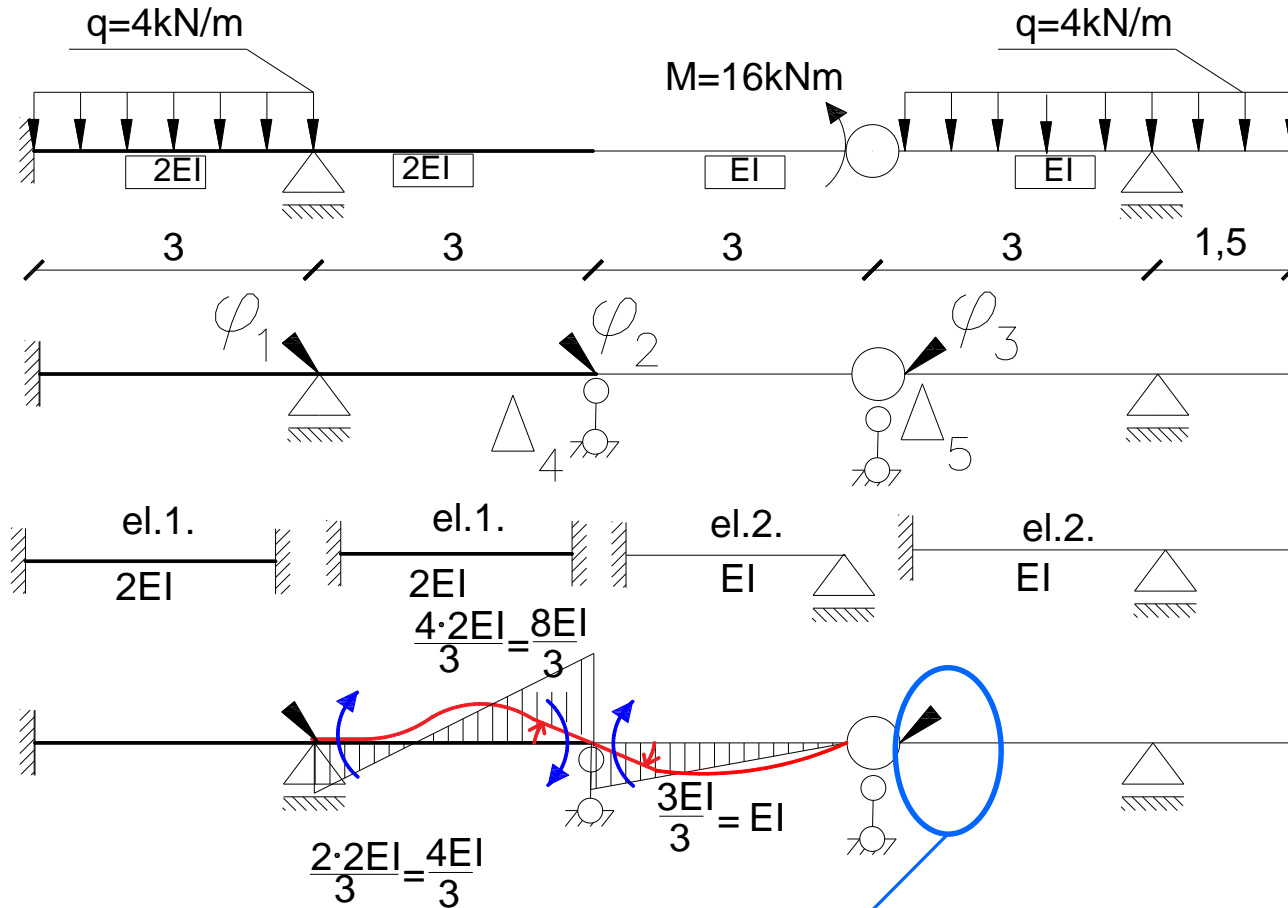

Stan  $\varphi_2=1$

$$k_{12} = \frac{4EI}{3}$$

$$k_{31} = 0$$

$$k_{22} = \frac{8EI}{3} + EI = \frac{11EI}{3}$$



# Wykresy jednostkowe:

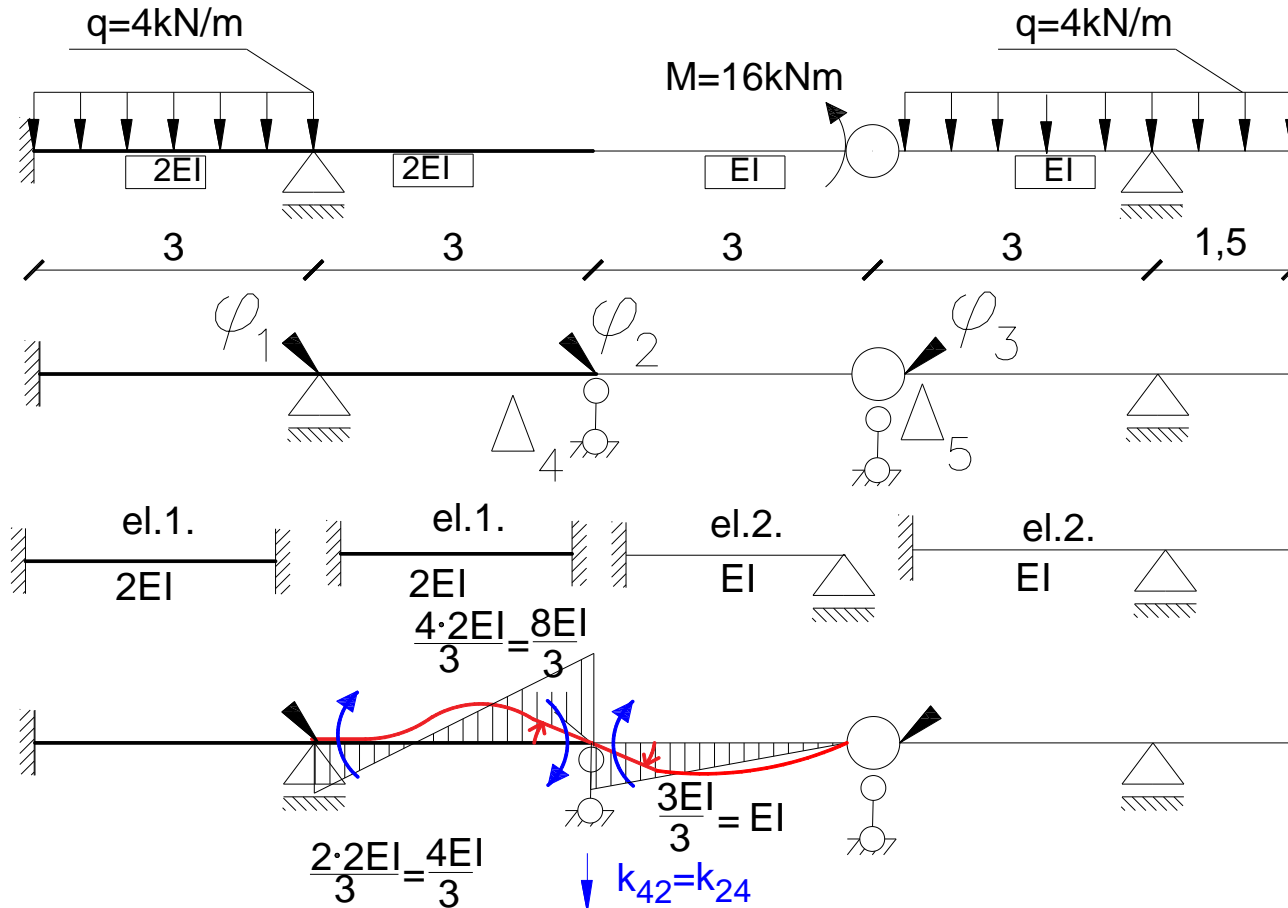

Stan  $\varphi_2=1$

$$k_{12} = \frac{4EI}{3}$$

$$k_{31} = 0$$

$$k_{22} = \frac{8EI}{3} + EI = \frac{11EI}{3}$$

# Wykresy jednostkowe:

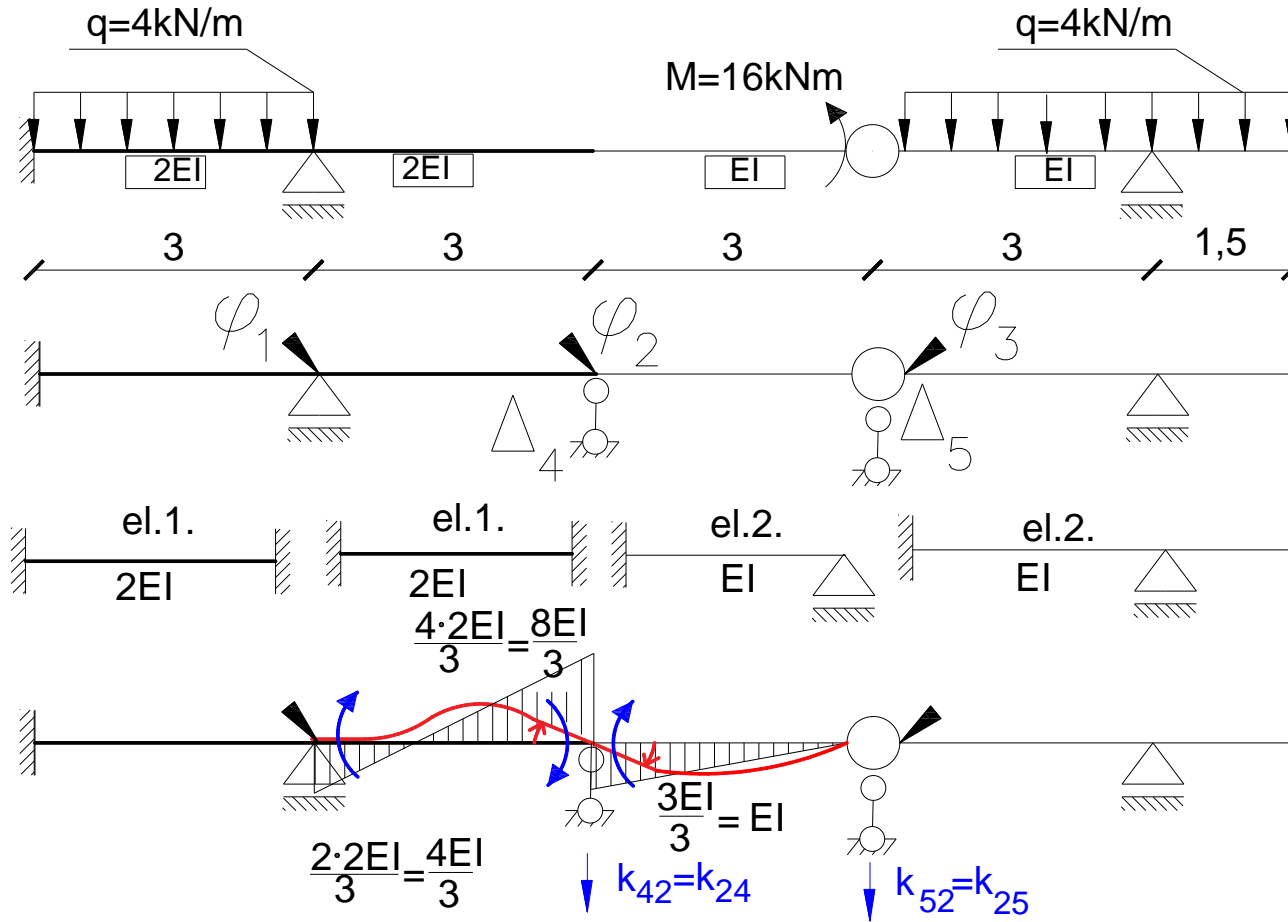

Stan  $\varphi_2=1$

$$k_{12} = \frac{4EI}{3}$$

$$k_{31} = 0$$

$$k_{22} = \frac{8EI}{3} + EI = \frac{11EI}{3}$$

# Wykresy jednostkowe:

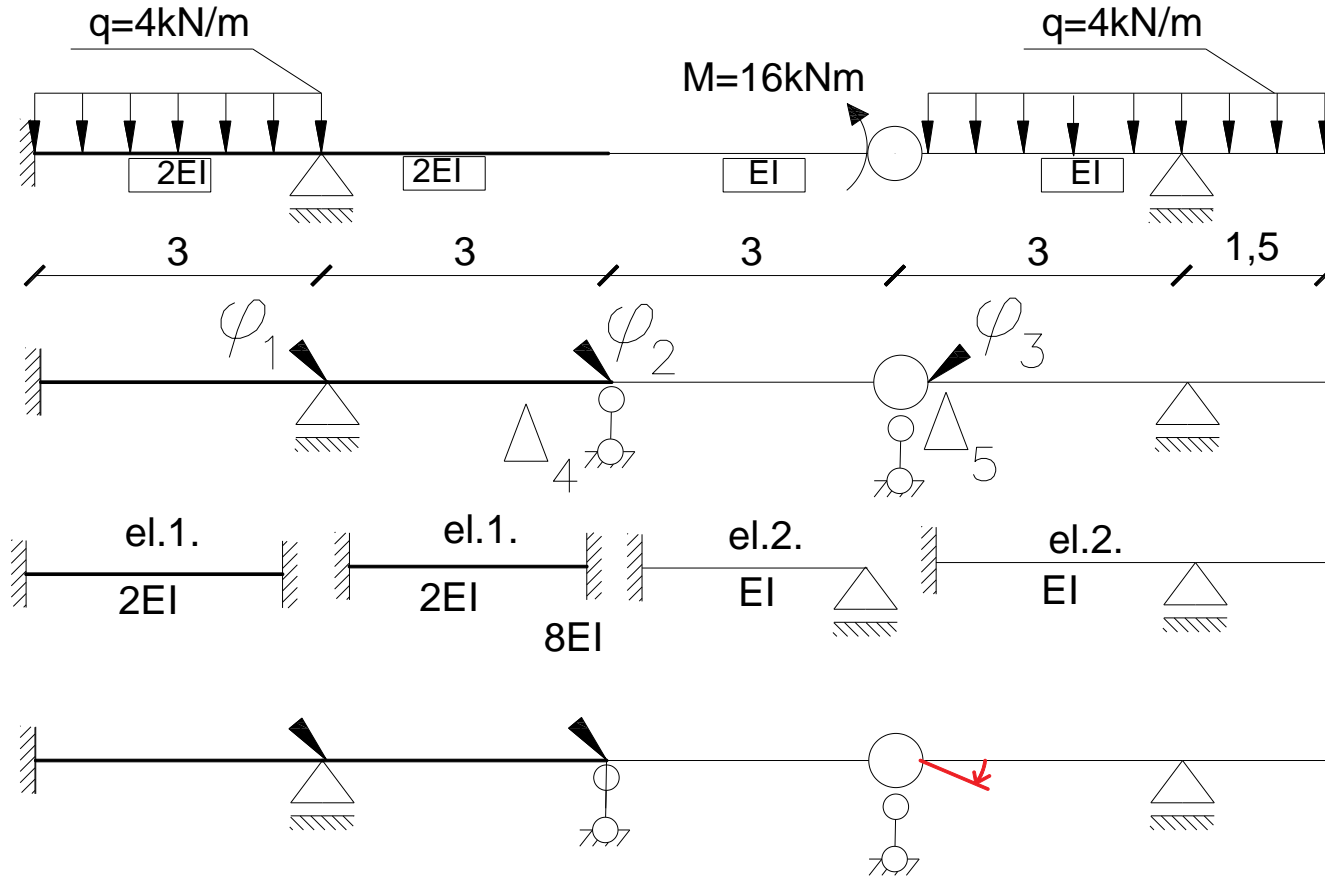

Stan  $\varphi_3=1$

# Wykresy jednostkowe:

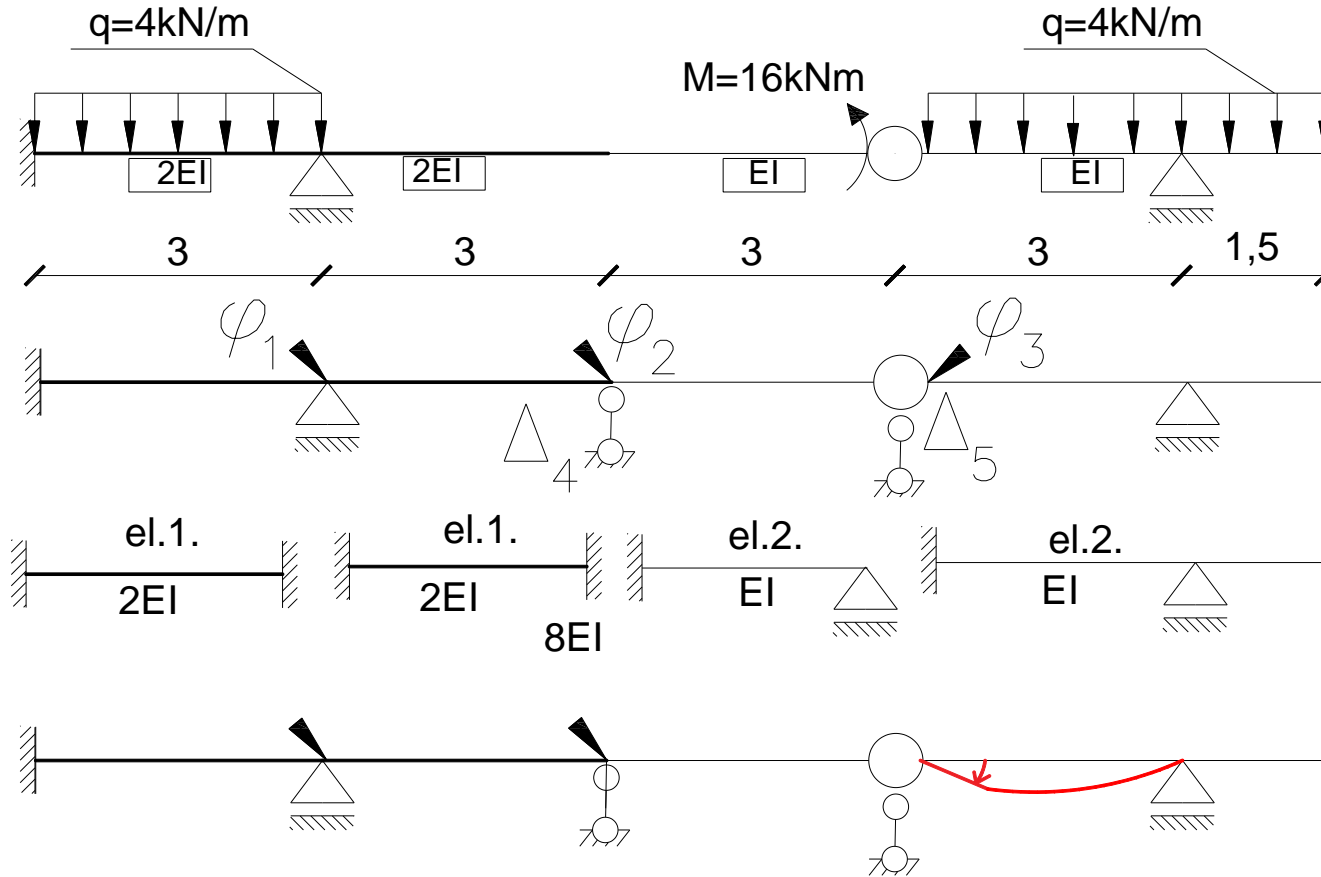

Stan  $\varphi_3=1$

# Wykresy jednostkowe:

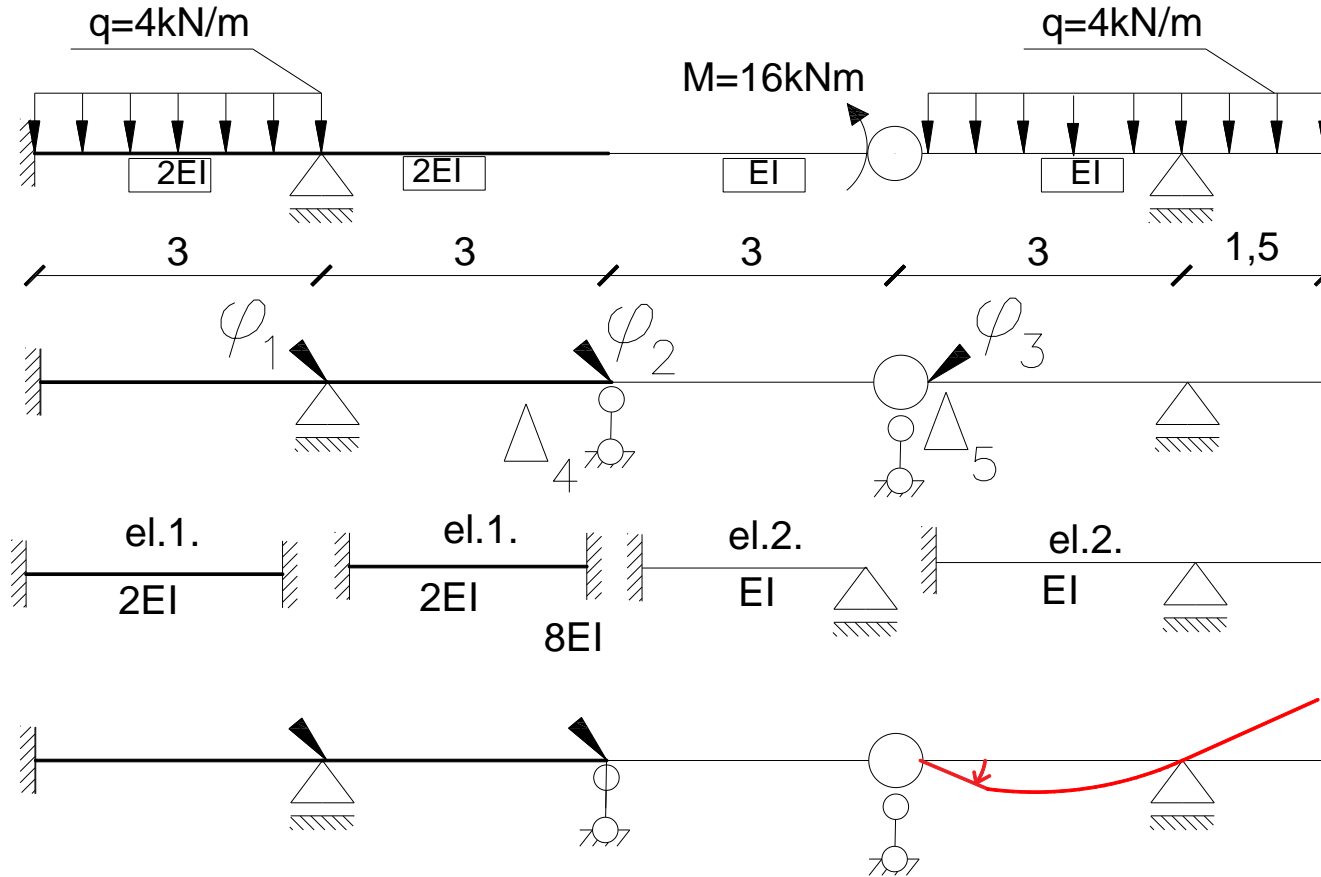

Stan  $\varphi_3=1$

# Wykresy jednostkowe:

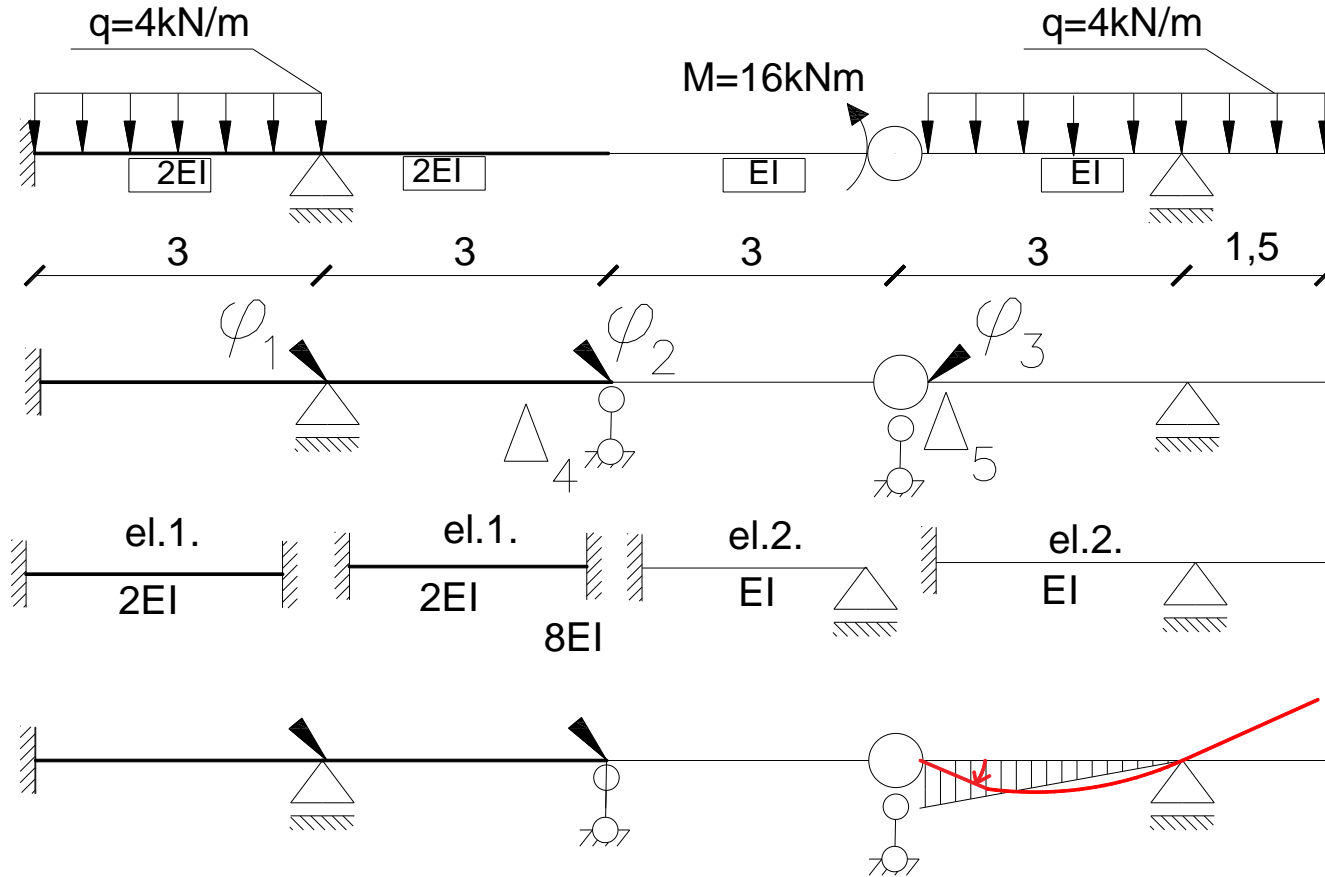

Stan  $\varphi_3=1$

	1	2	3	4
22		$3 \frac{EJ}{l}$	0	

# Wykresy jednostkowe:

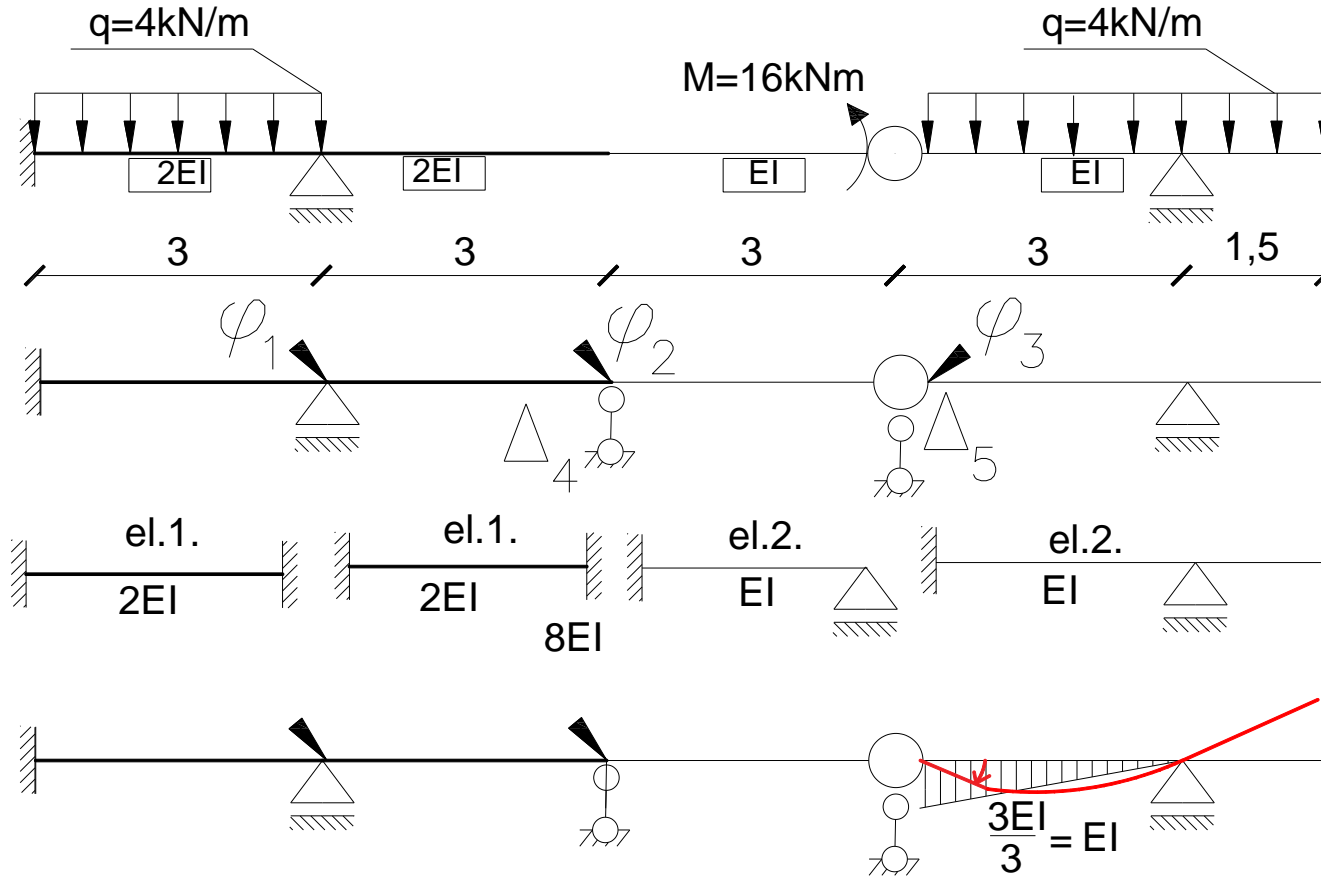

Stan  $\varphi_3=1$

	1	2	3	4
22		$3 \frac{EJ}{l}$	0	

# Wykresy jednostkowe:

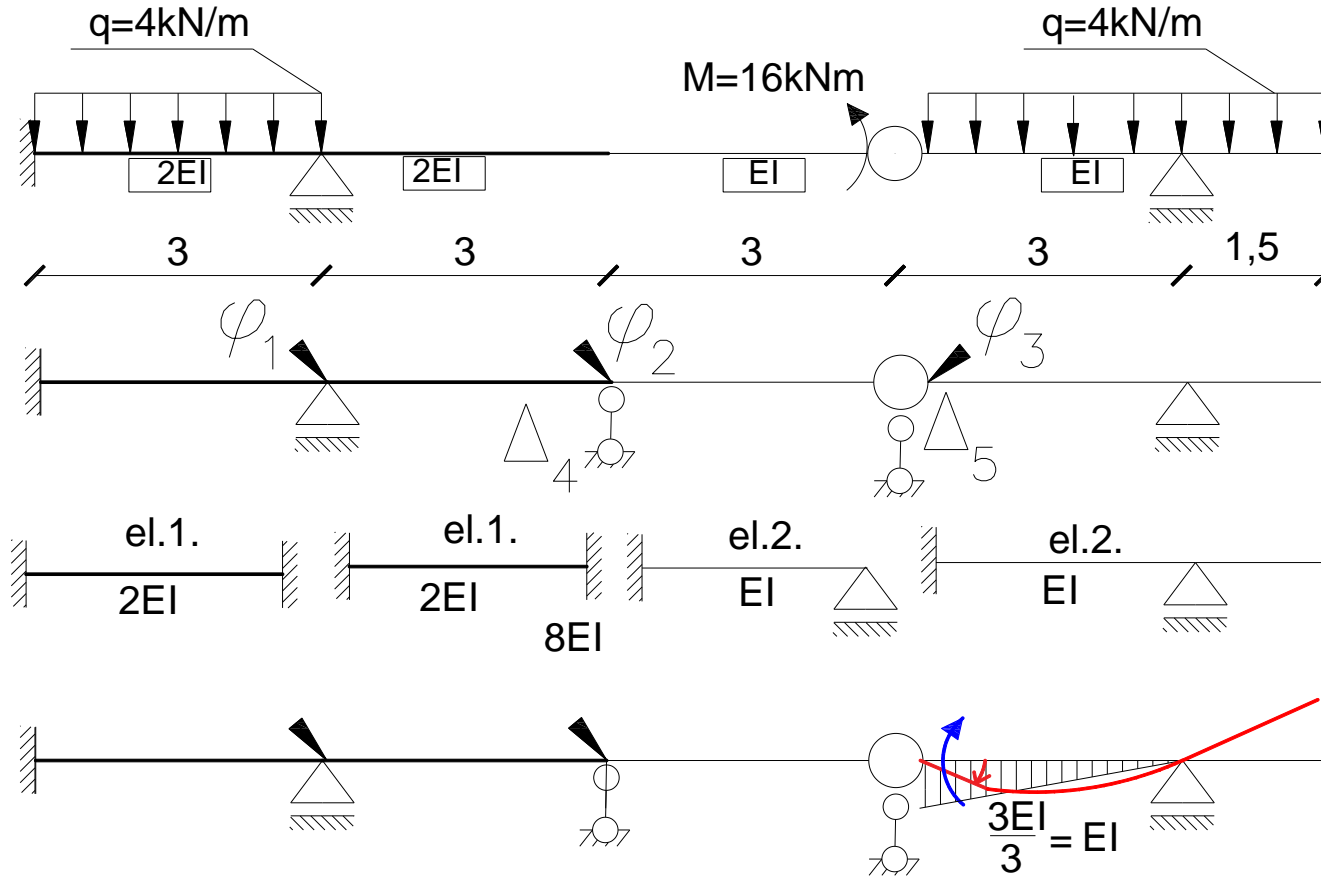

Stan  $\varphi_3=1$

	1	2	3	4
22		$\frac{3EI}{l}$	0	0



# Wykresy jednostkowe:

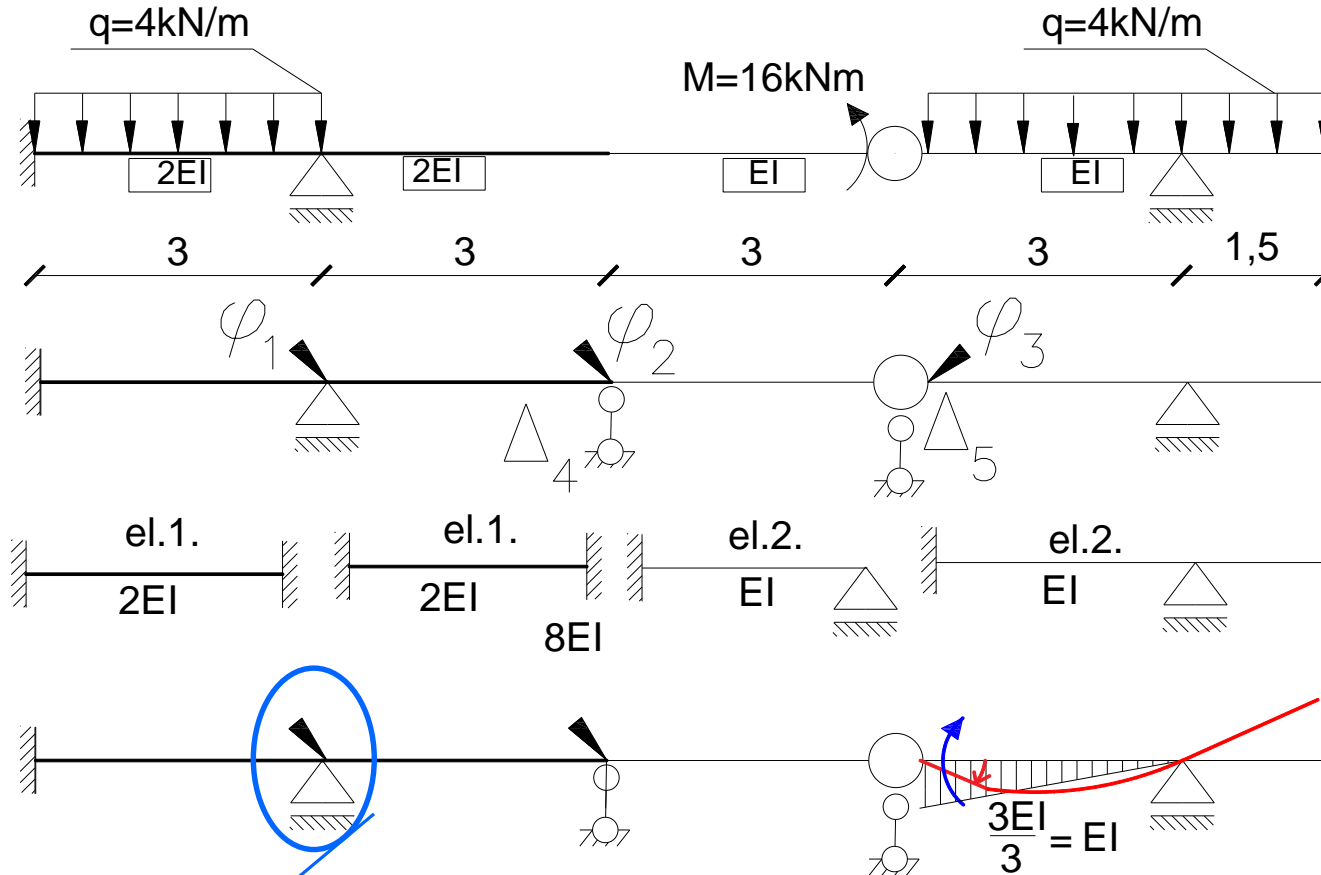

Stan  $\varphi_3=1$

$k_{13} = 0$

# Wykresy jednostkowe:

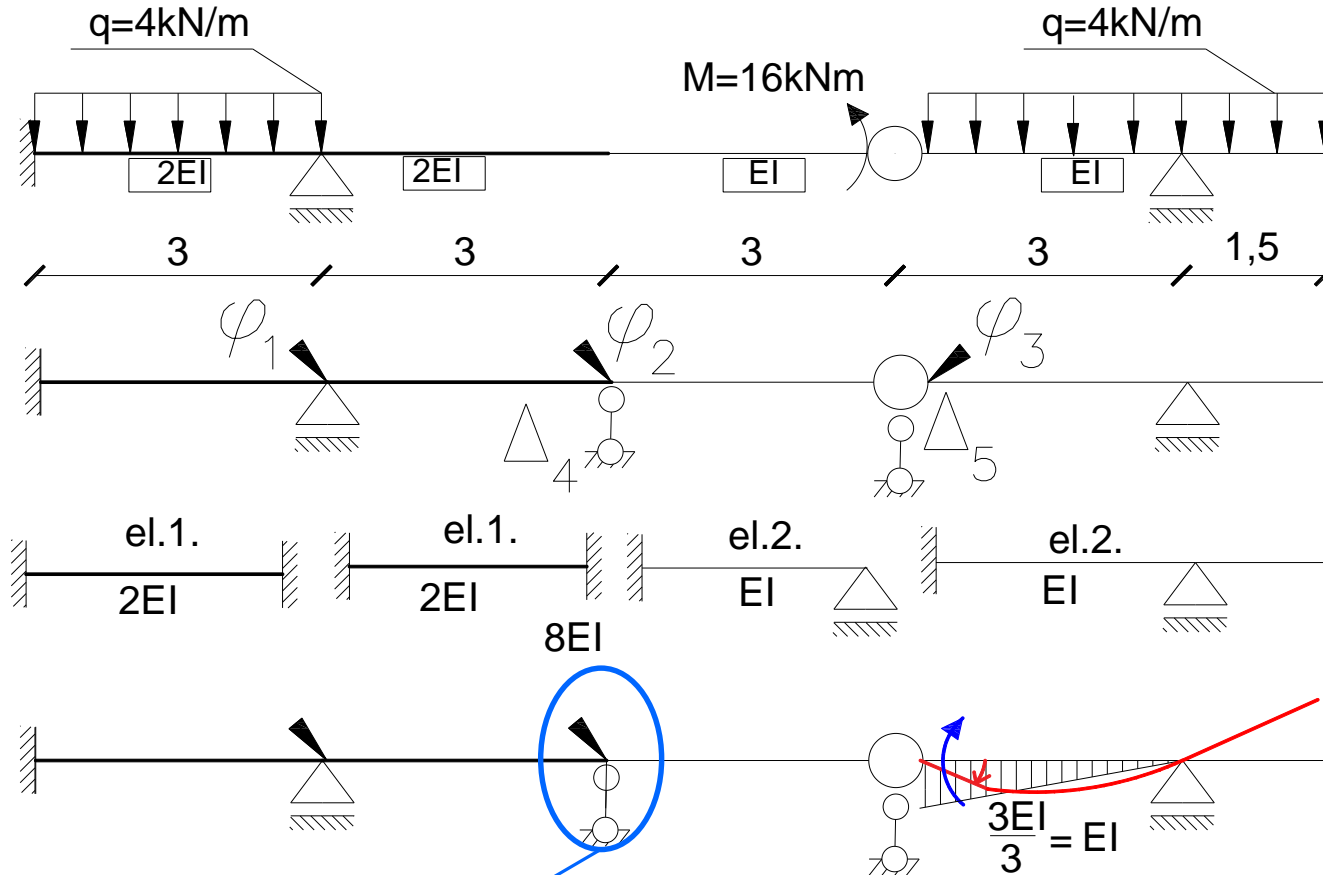

Stan  $\varphi_3=1$

$$k_{13} = 0$$

$$k_{23} = 0$$

# Wykresy jednostkowe:

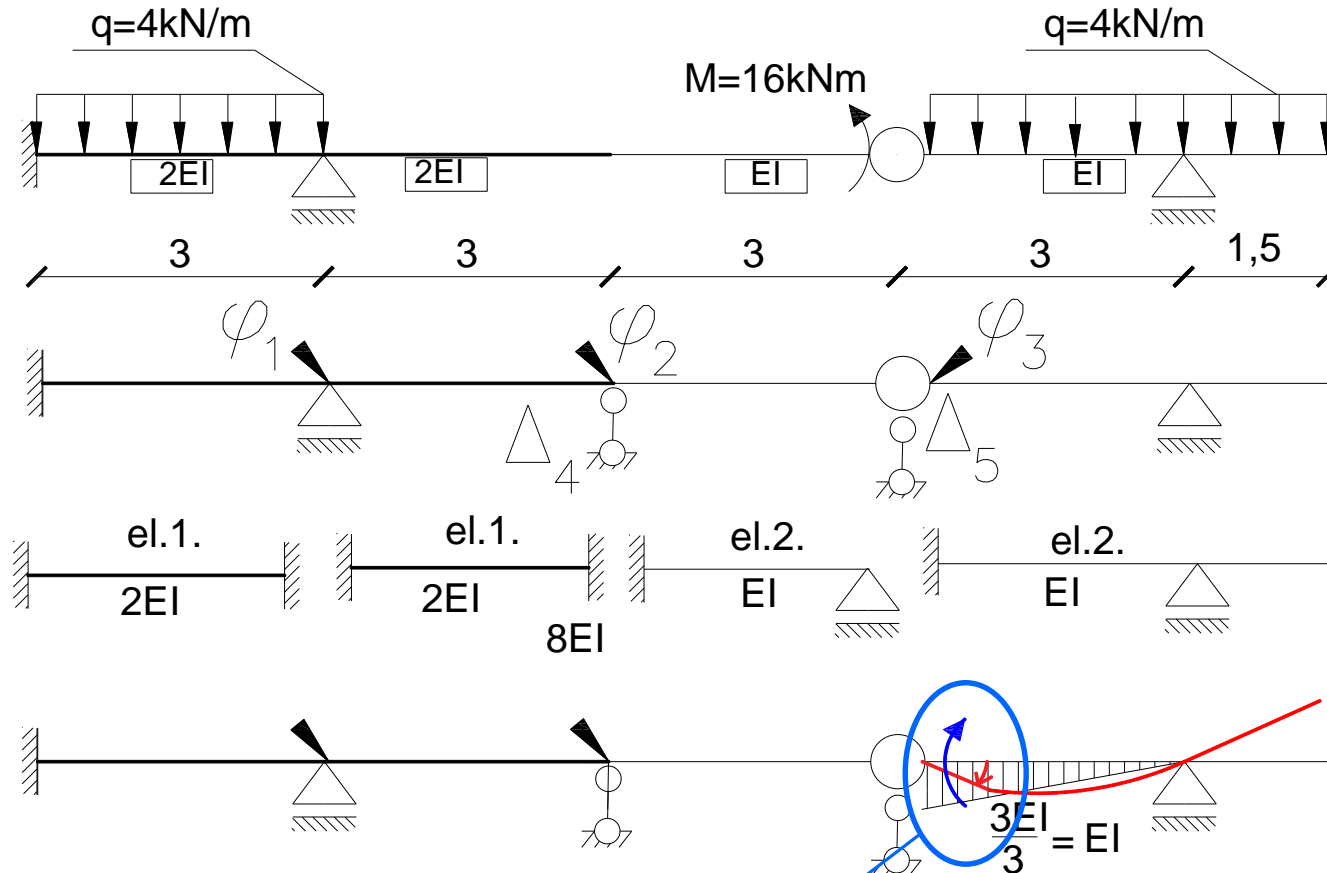

Stan  $\varphi_3=1$

$k_{13} = 0$

$k_{33} = EI$

$k_{23} = 0$

# Wykresy jednostkowe:

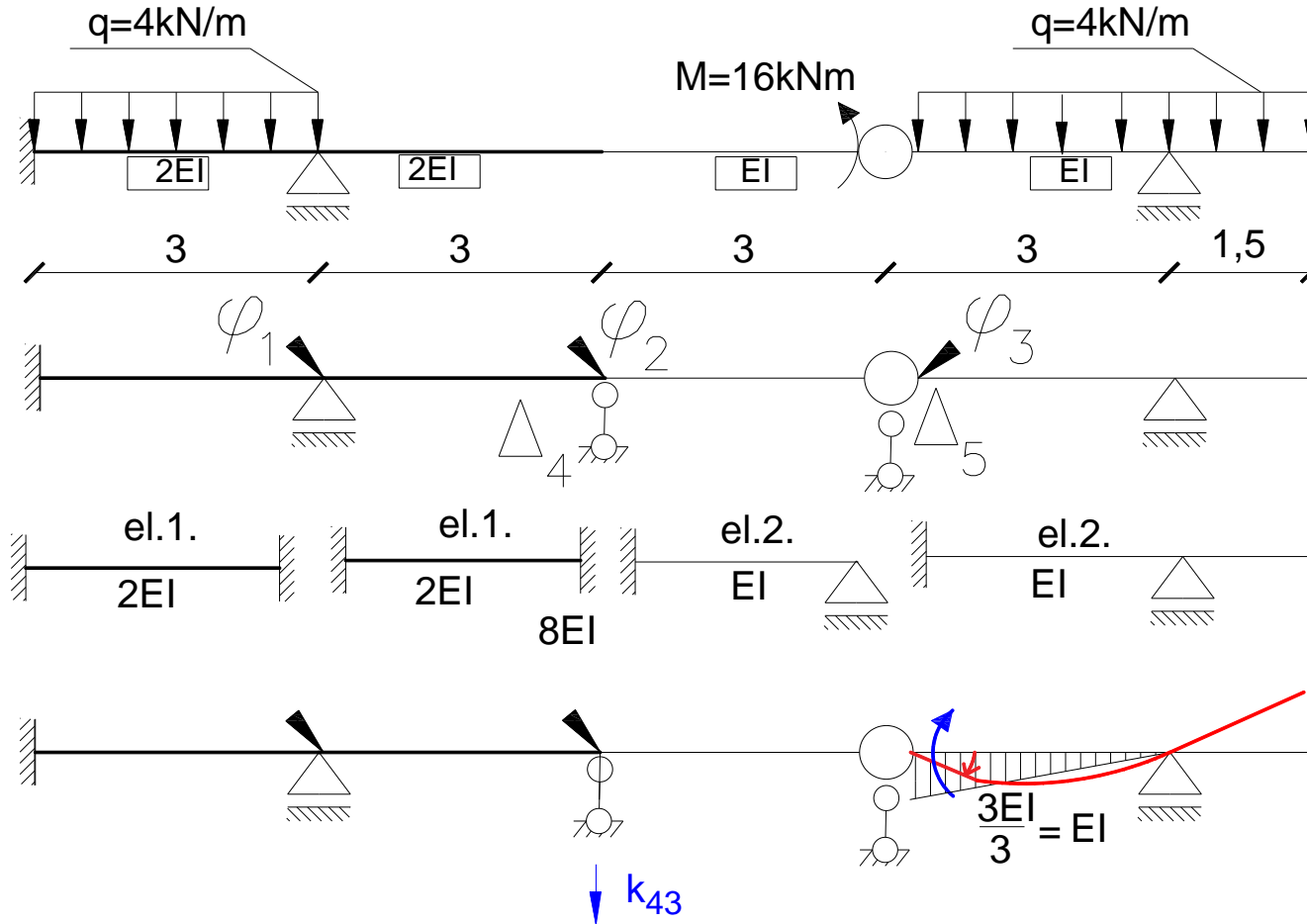

Stan  $\varphi_3=1$

$$k_{13} = 0$$

$$k_{33} = EI$$

$$k_{23} = 0$$

# Wykresy jednostkowe:

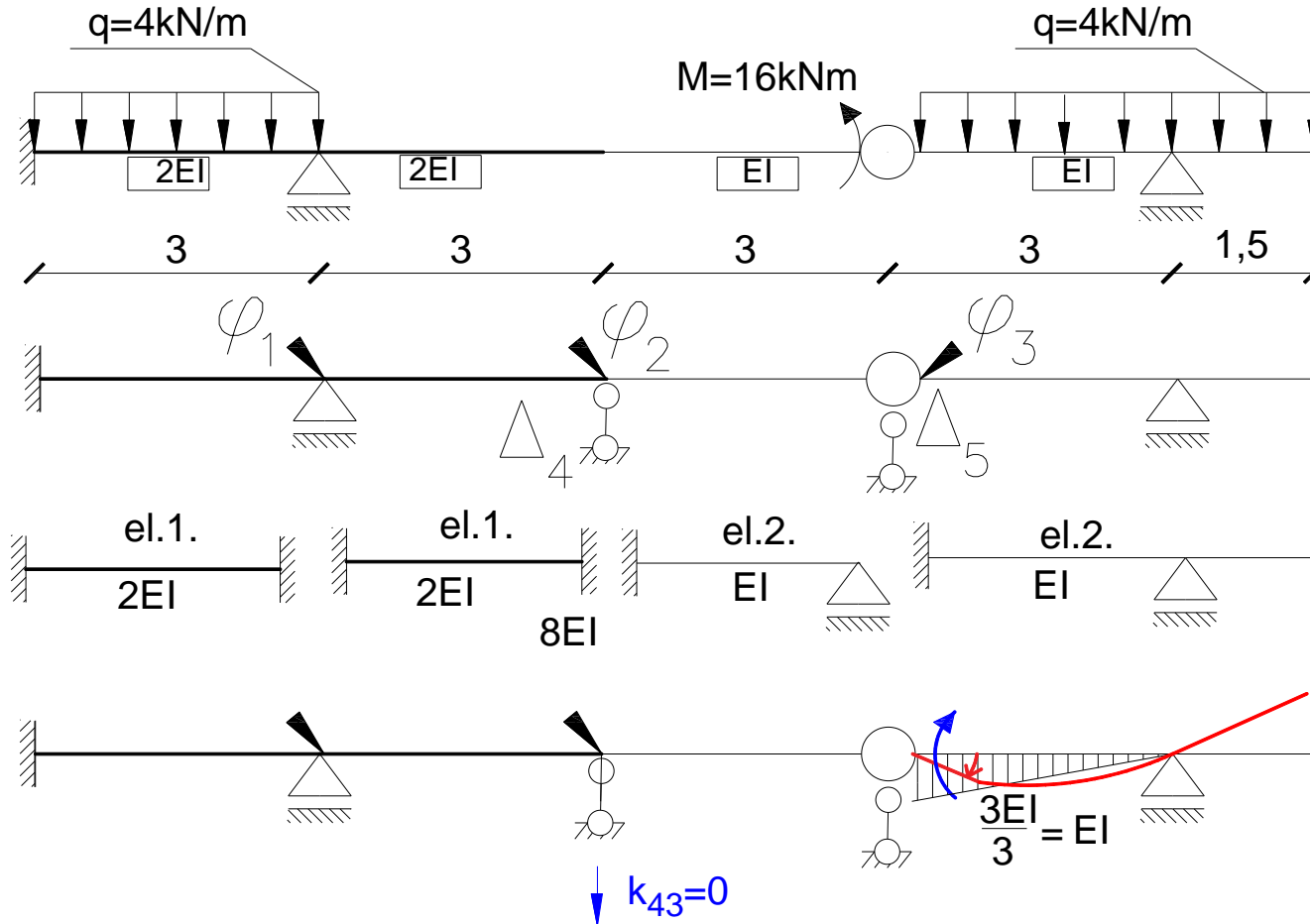

Stan  $\varphi_3=1$

$$k_{13} = 0$$

$$k_{33} = EI$$

$$k_{23} = 0$$

# Wykresy jednostkowe:

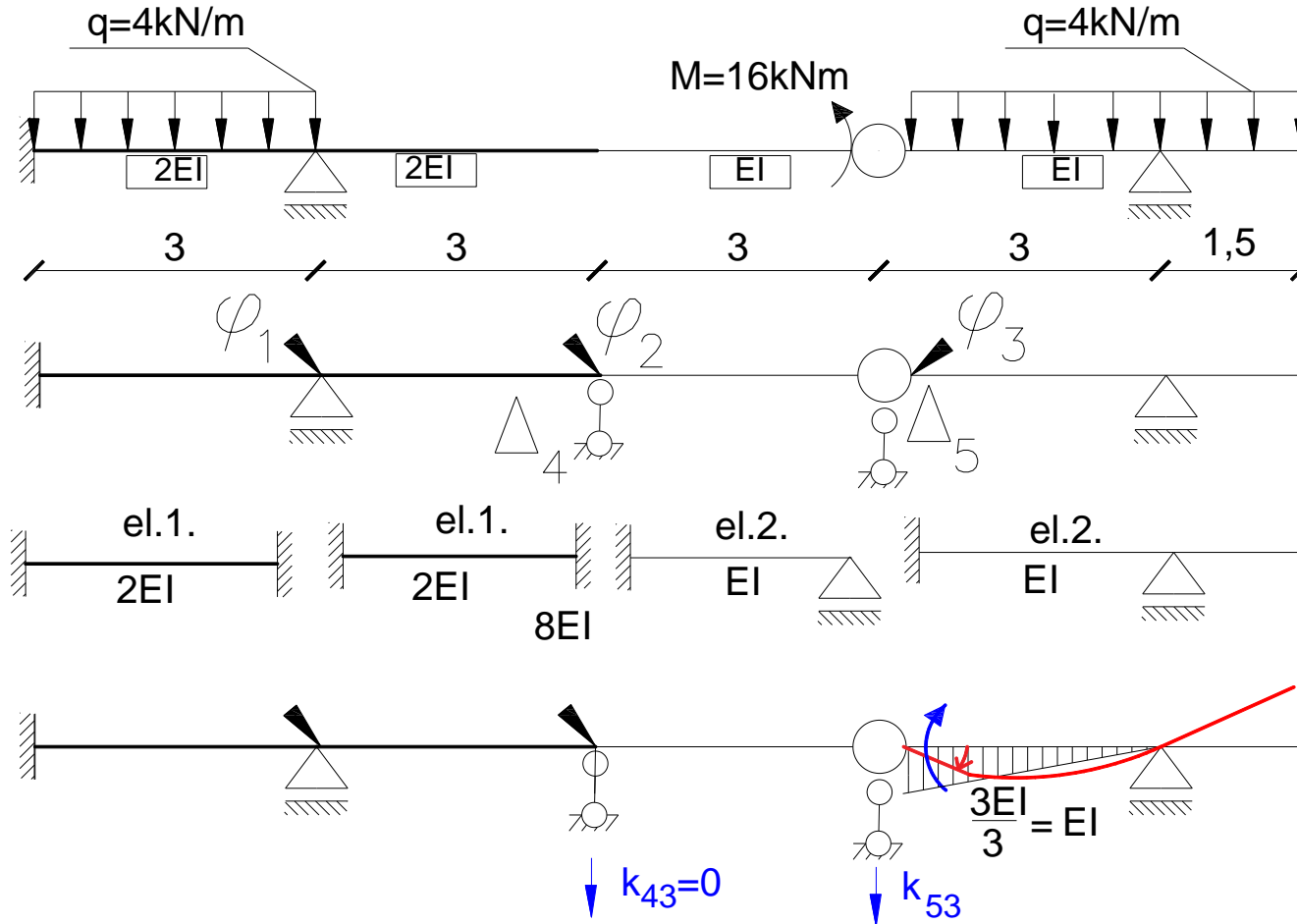

Stan  $\varphi_3=1$

$$k_{13} = 0$$

$$k_{33} = EI$$

$$k_{23} = 0$$

# Wykresy jednostkowe:

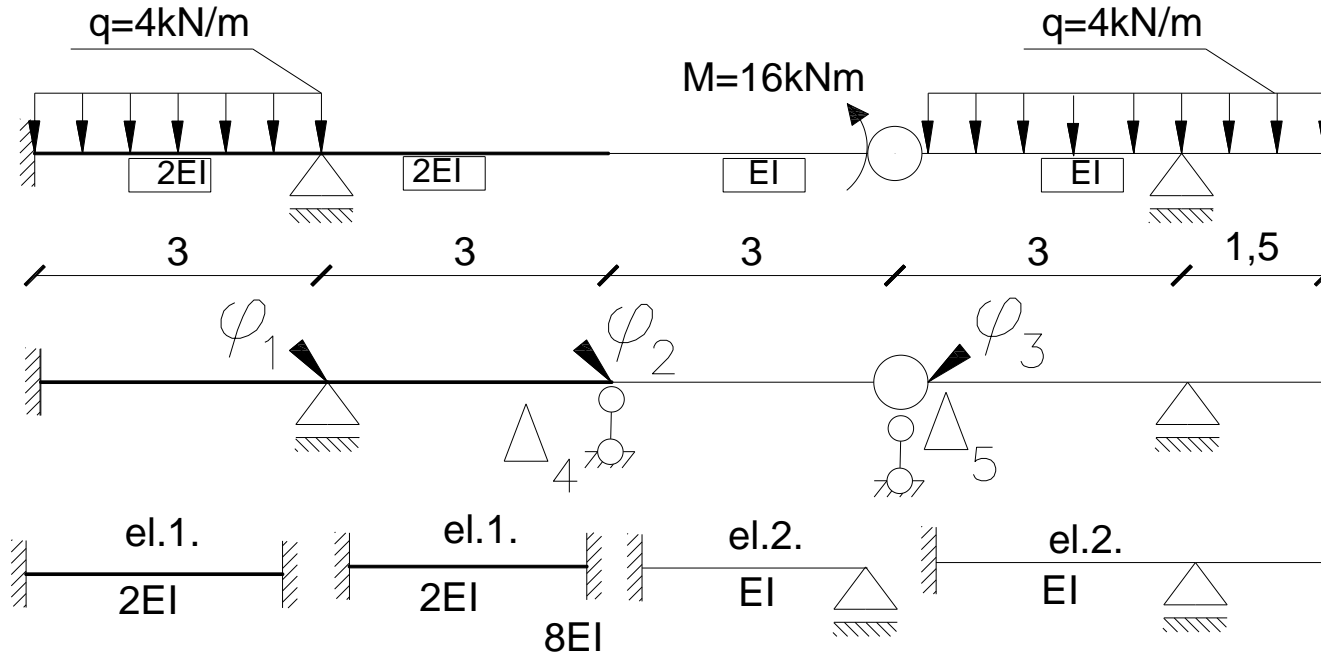

Stan  $\varphi_3=1$

$$k_{13} = 0$$

$$k_{23} = 0$$

$$k_{43} = 0$$

$$k_{33} = EI$$

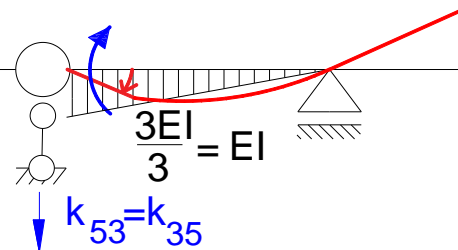

# Wykresy jednostkowe:

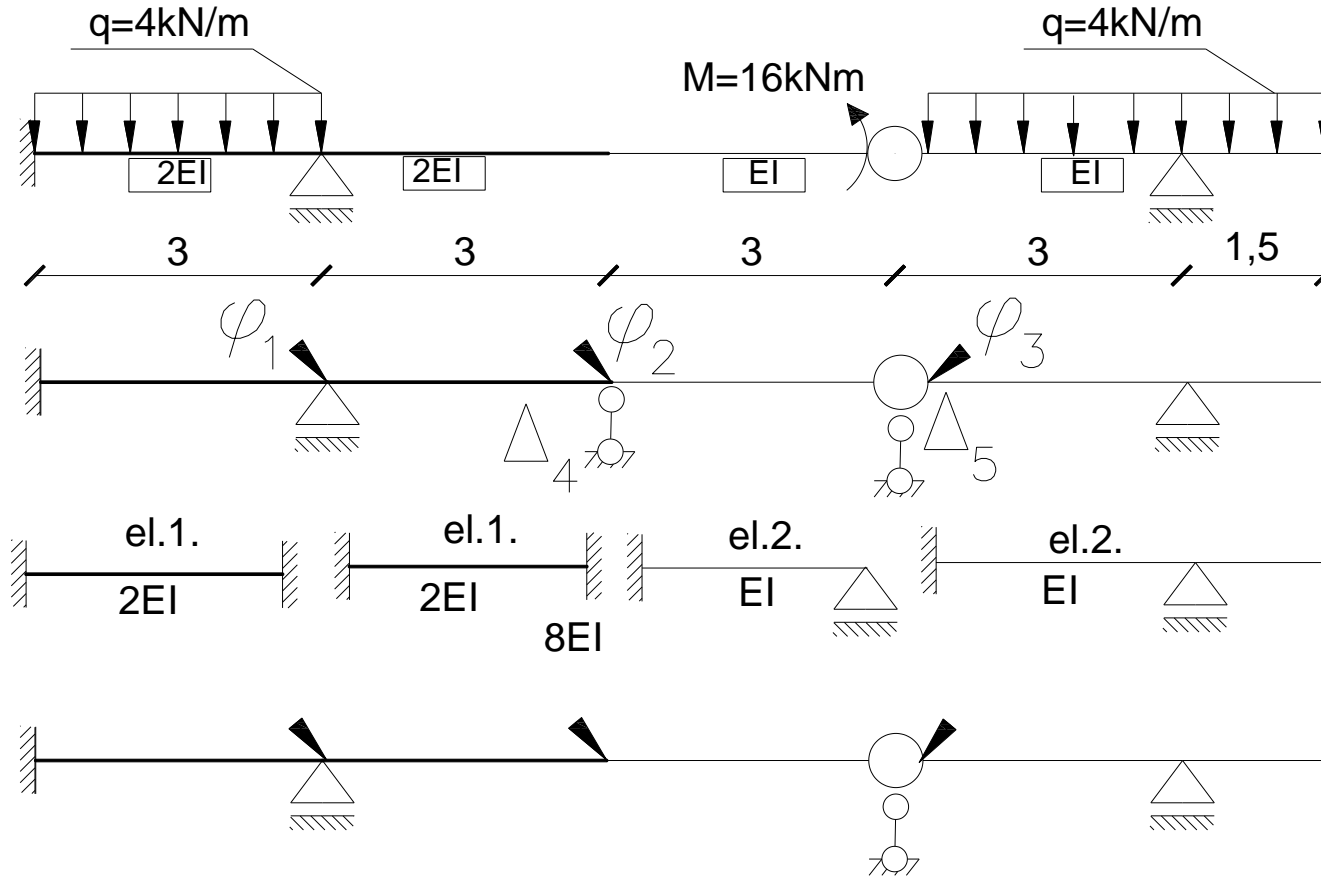

Stan  $\Delta_4=1$



# Wykresy jednostkowe:

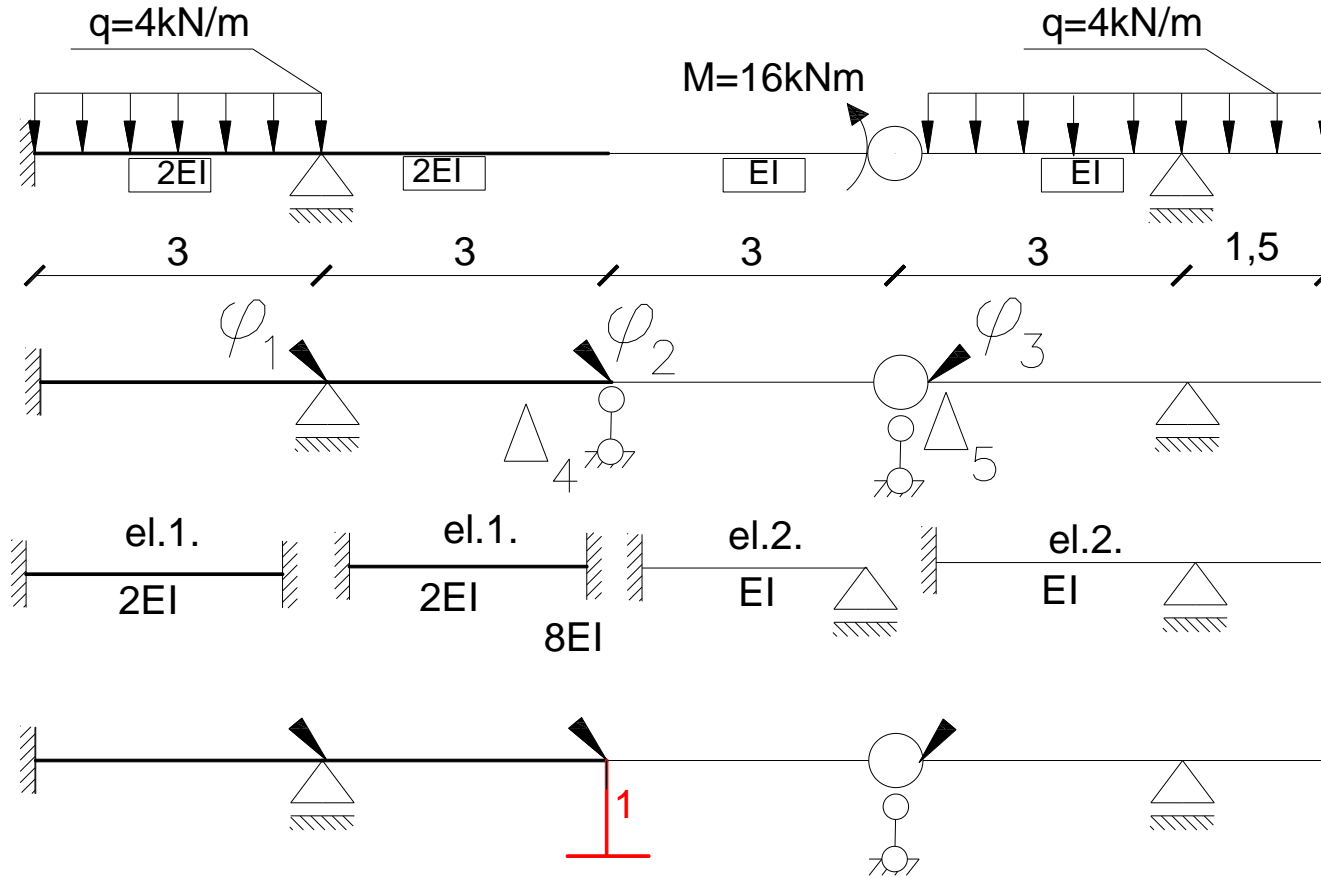

Stan  $\Delta_4=1$

# Wykresy jednostkowe:

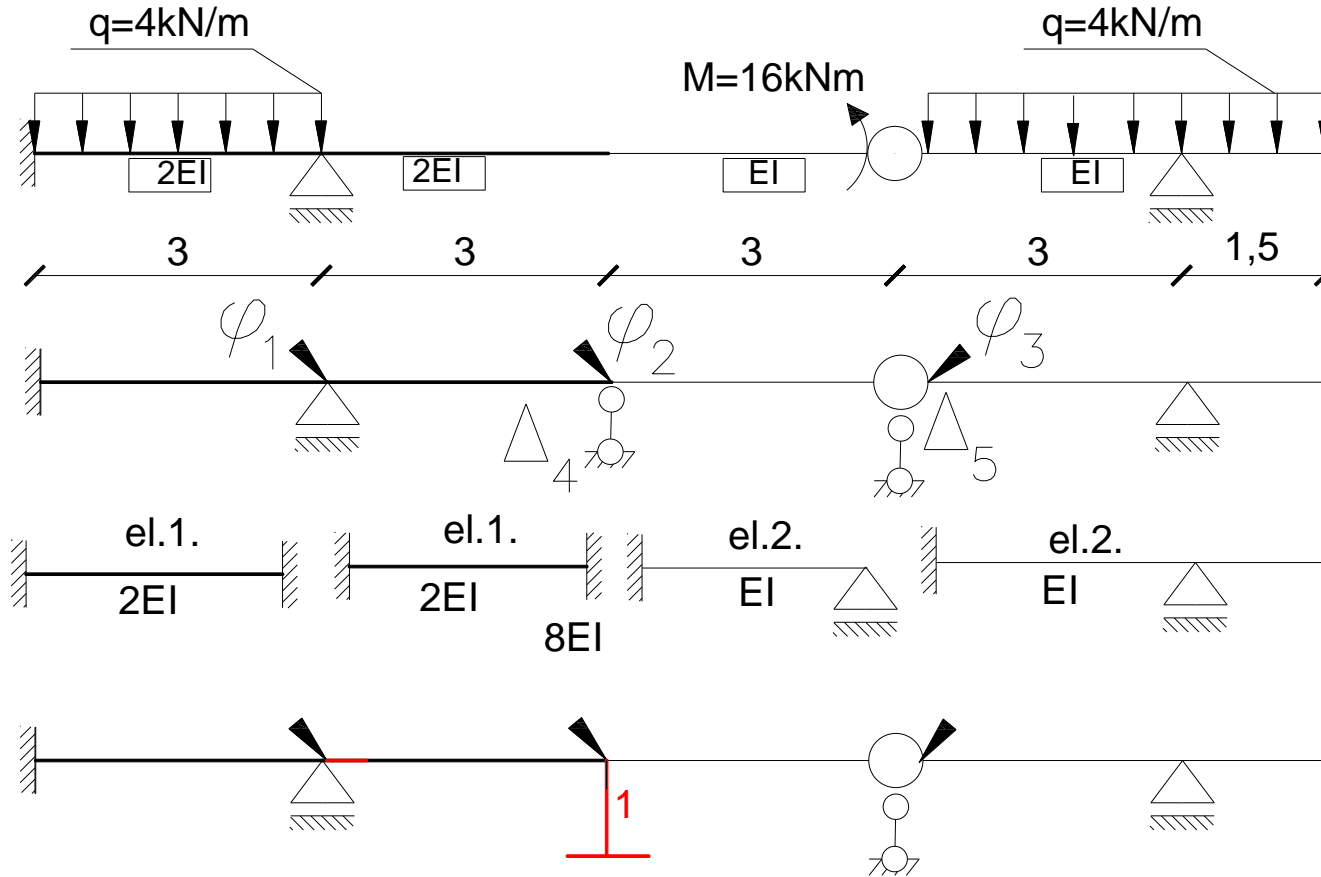

Stan  $\Delta_4=1$

# Wykresy jednostkowe:

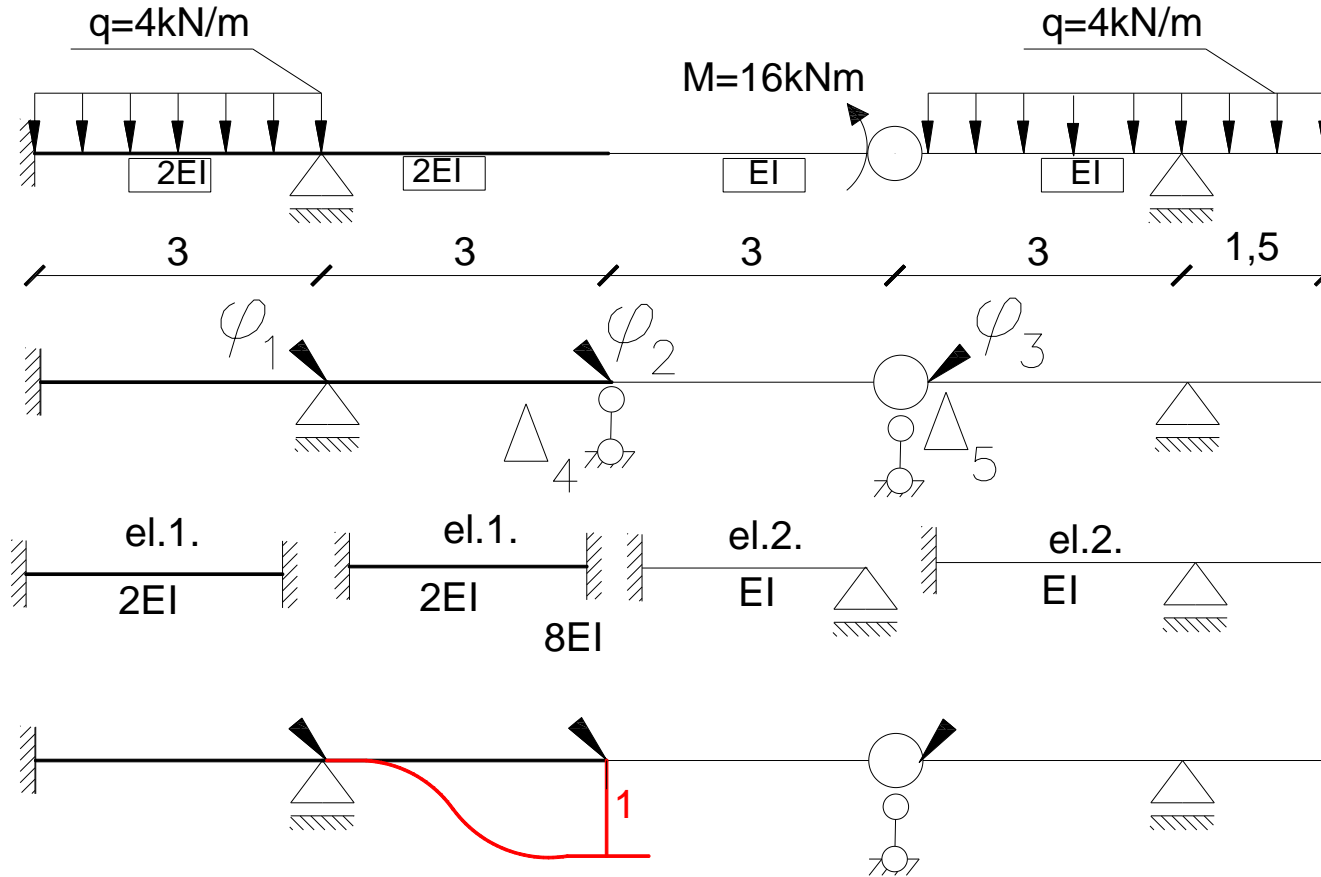

Stan  $\Delta_4=1$

# Wykresy jednostkowe:

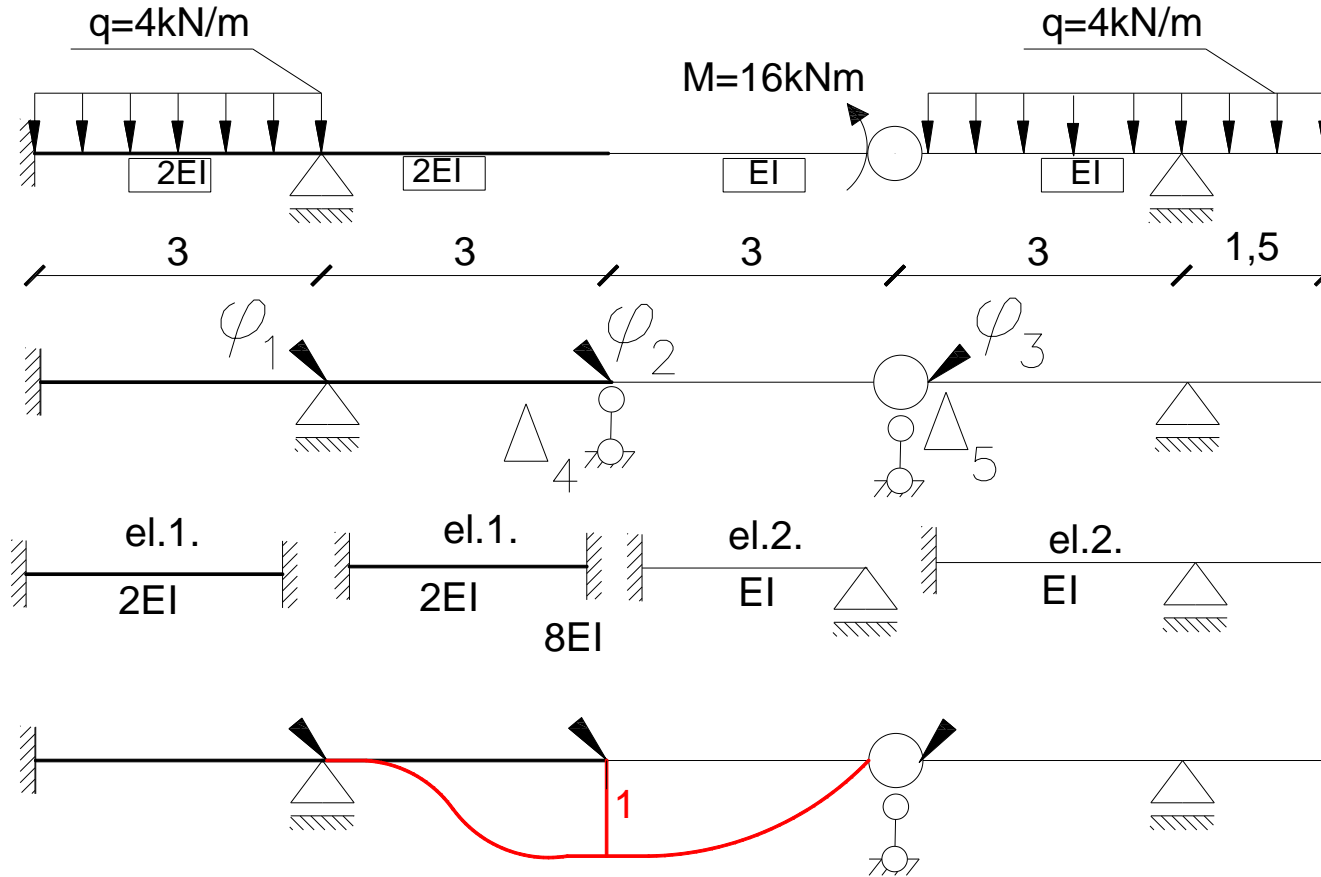

Stan  $\Delta_4=1$

# Wykresy jednostkowe:

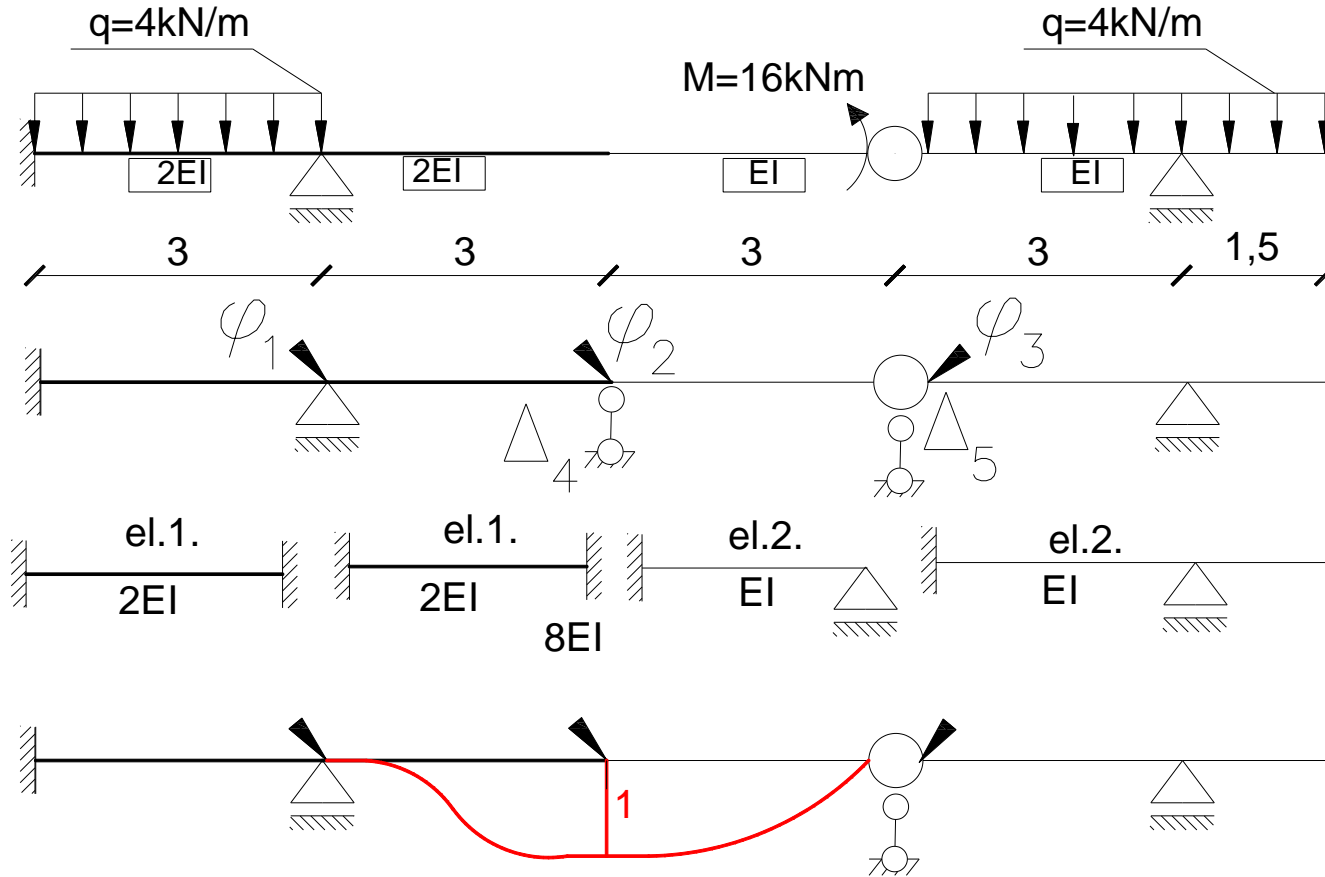

Stan  $\Delta_4=1$

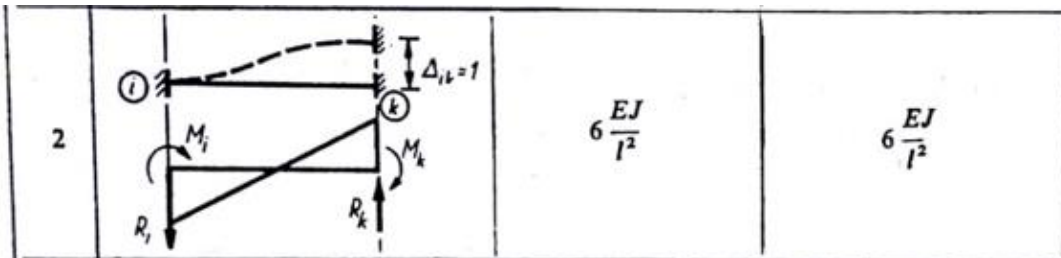

# Wykresy jednostkowe:

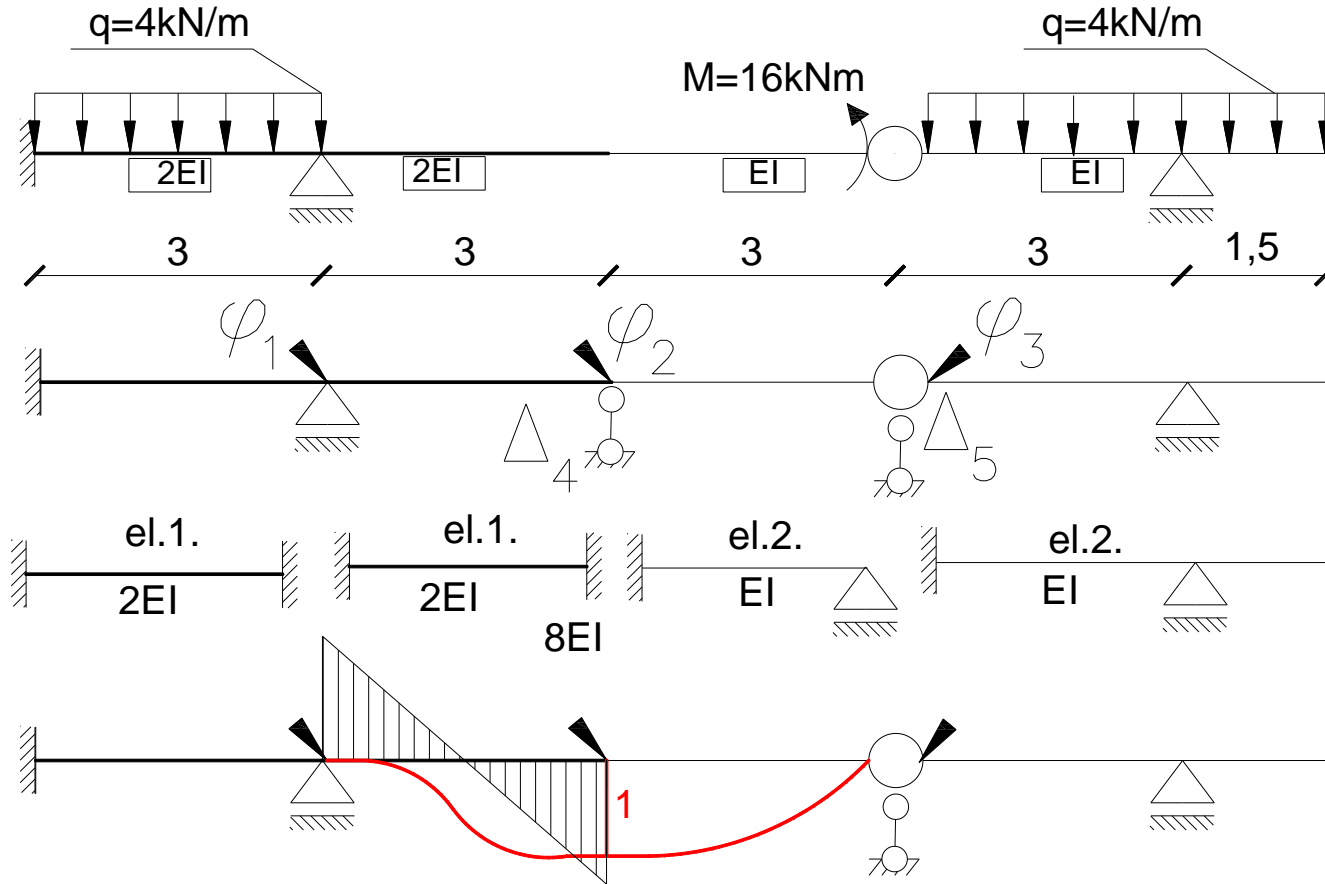

Stan  $\Delta_4=1$

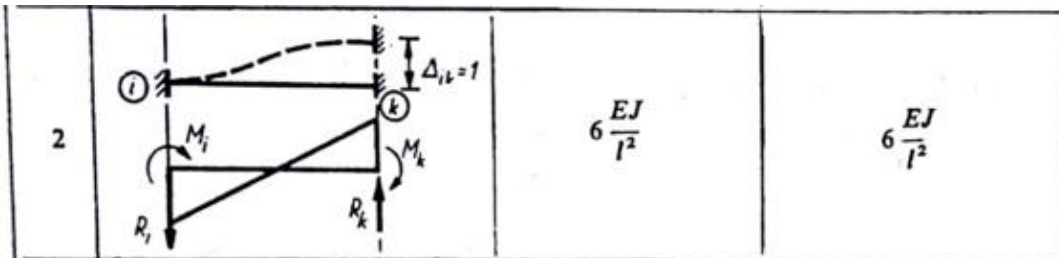

# Wykresy jednostkowe:

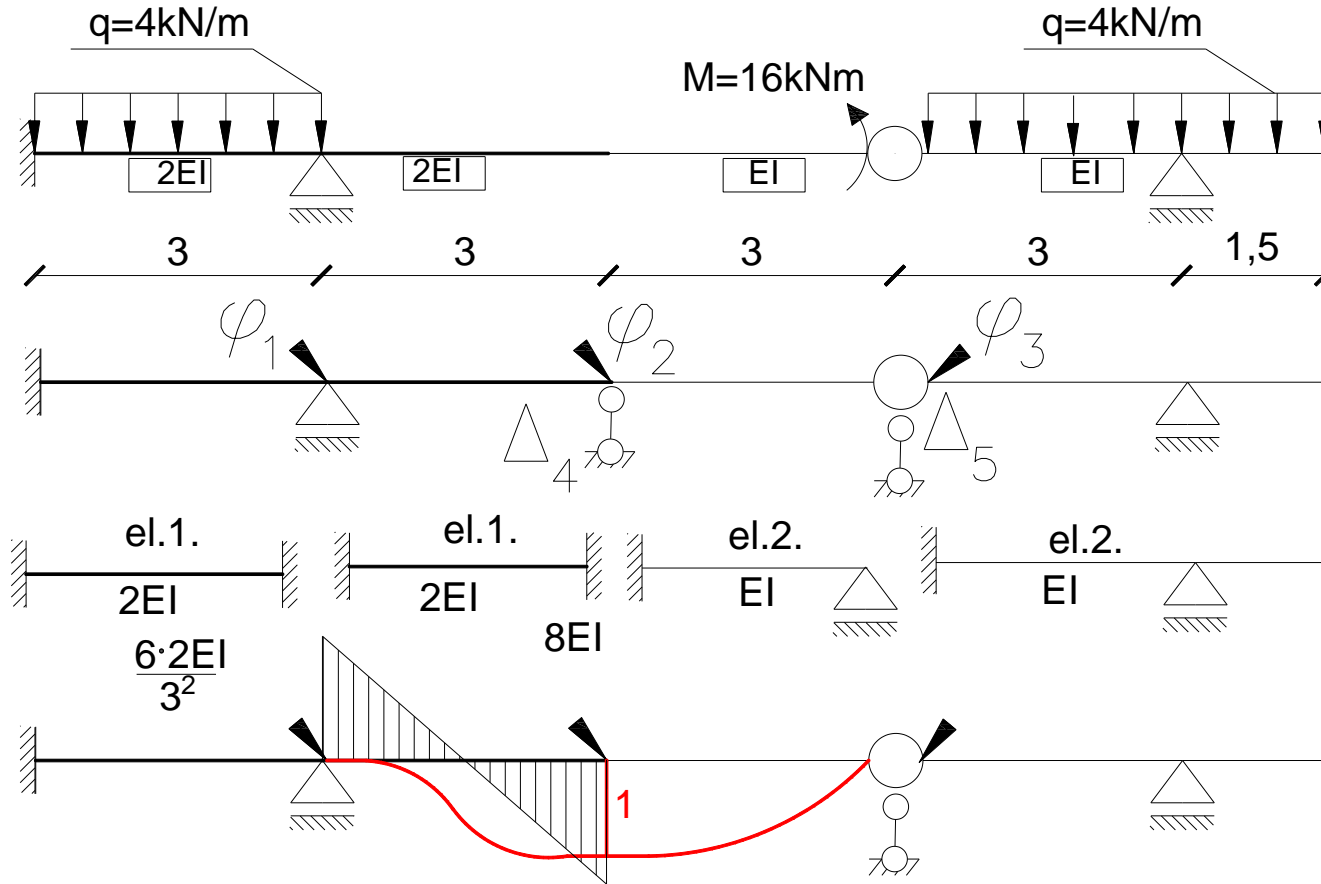

Stan  $\Delta_4=1$

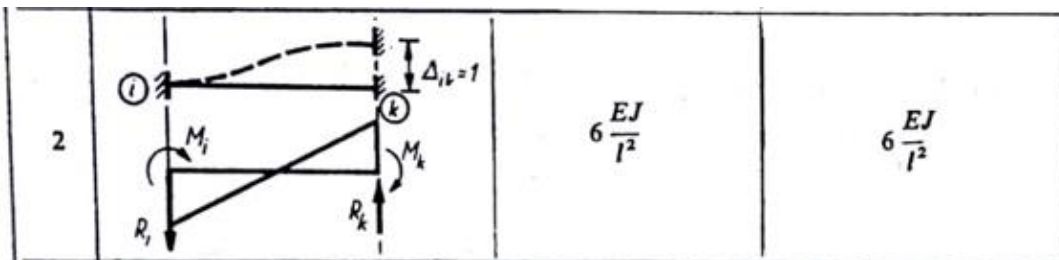

# Wykresy jednostkowe:

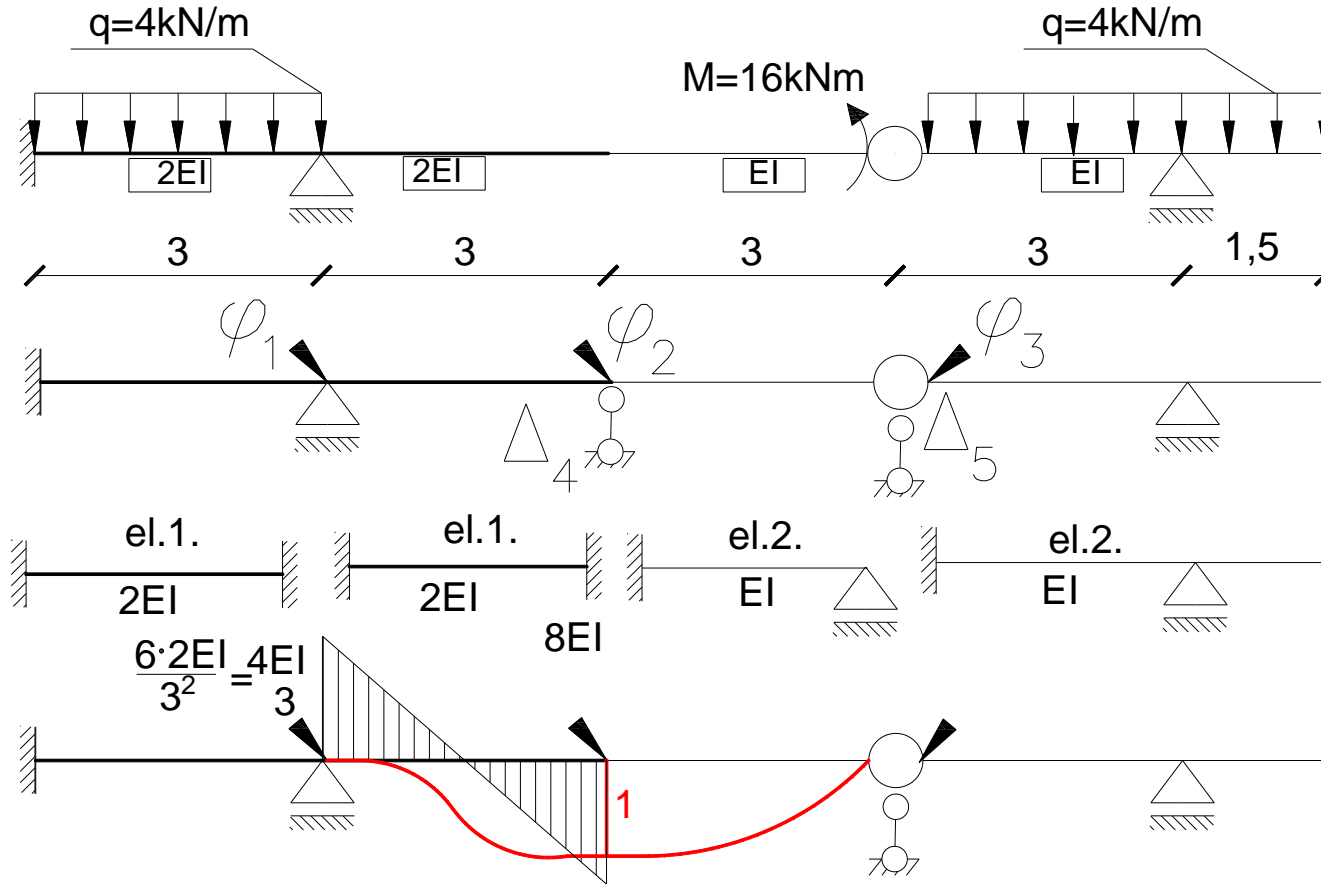

Stan  $\Delta_4=1$

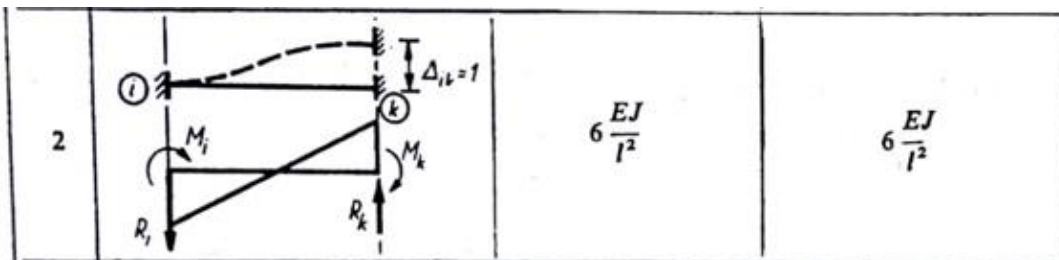



# Wykresy jednostkowe:

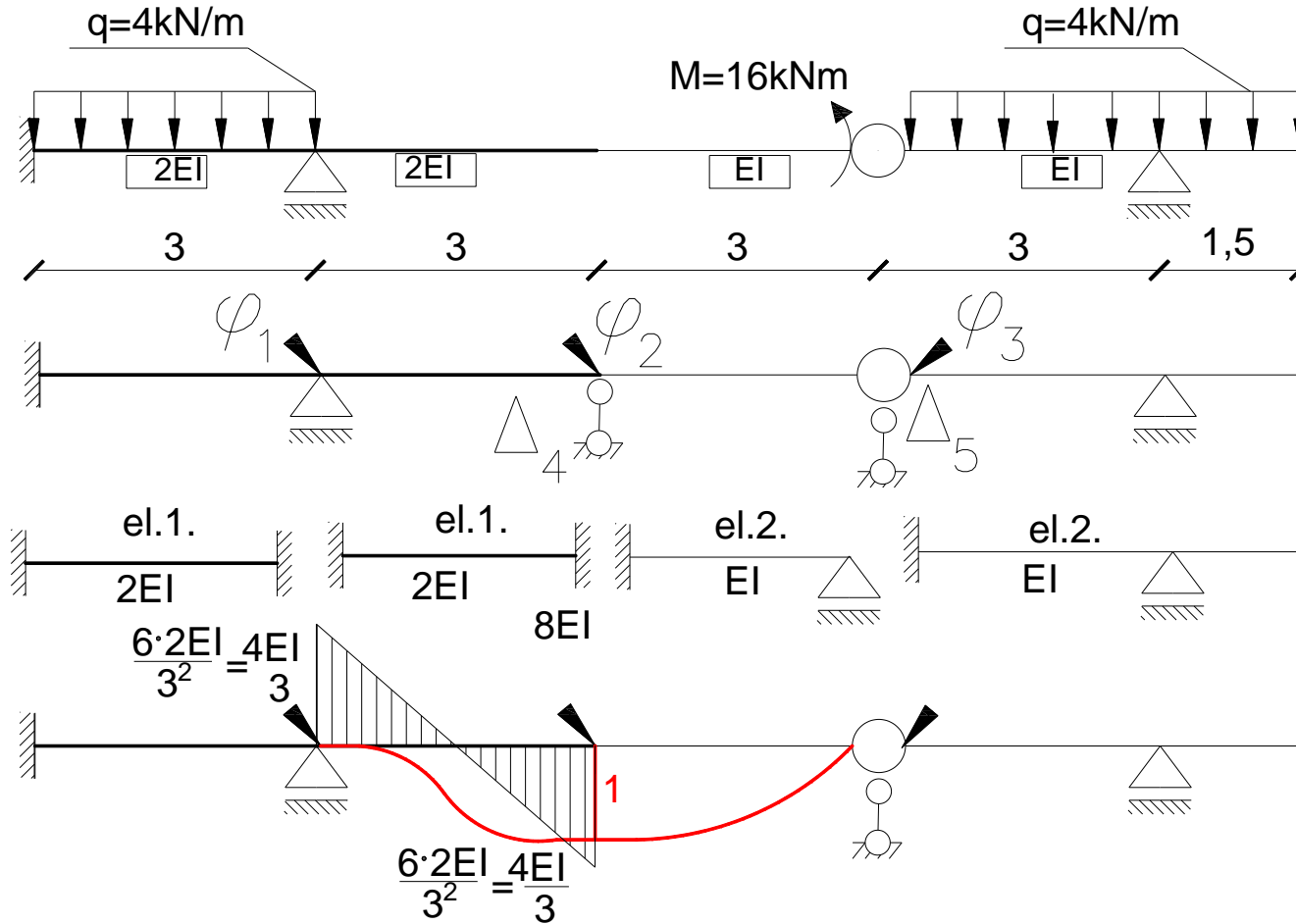

Stan  $\Delta_4=1$

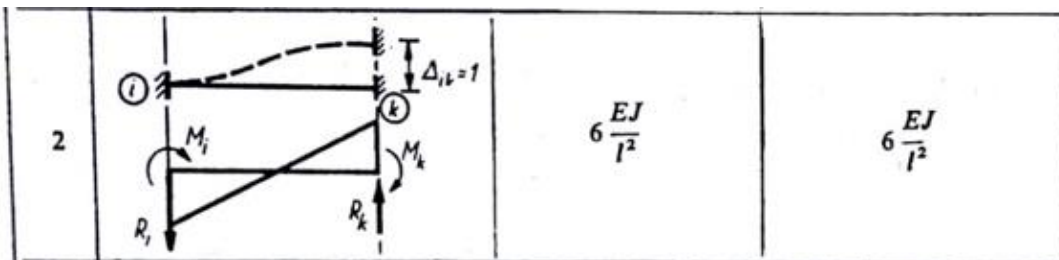

# Wykresy jednostkowe:

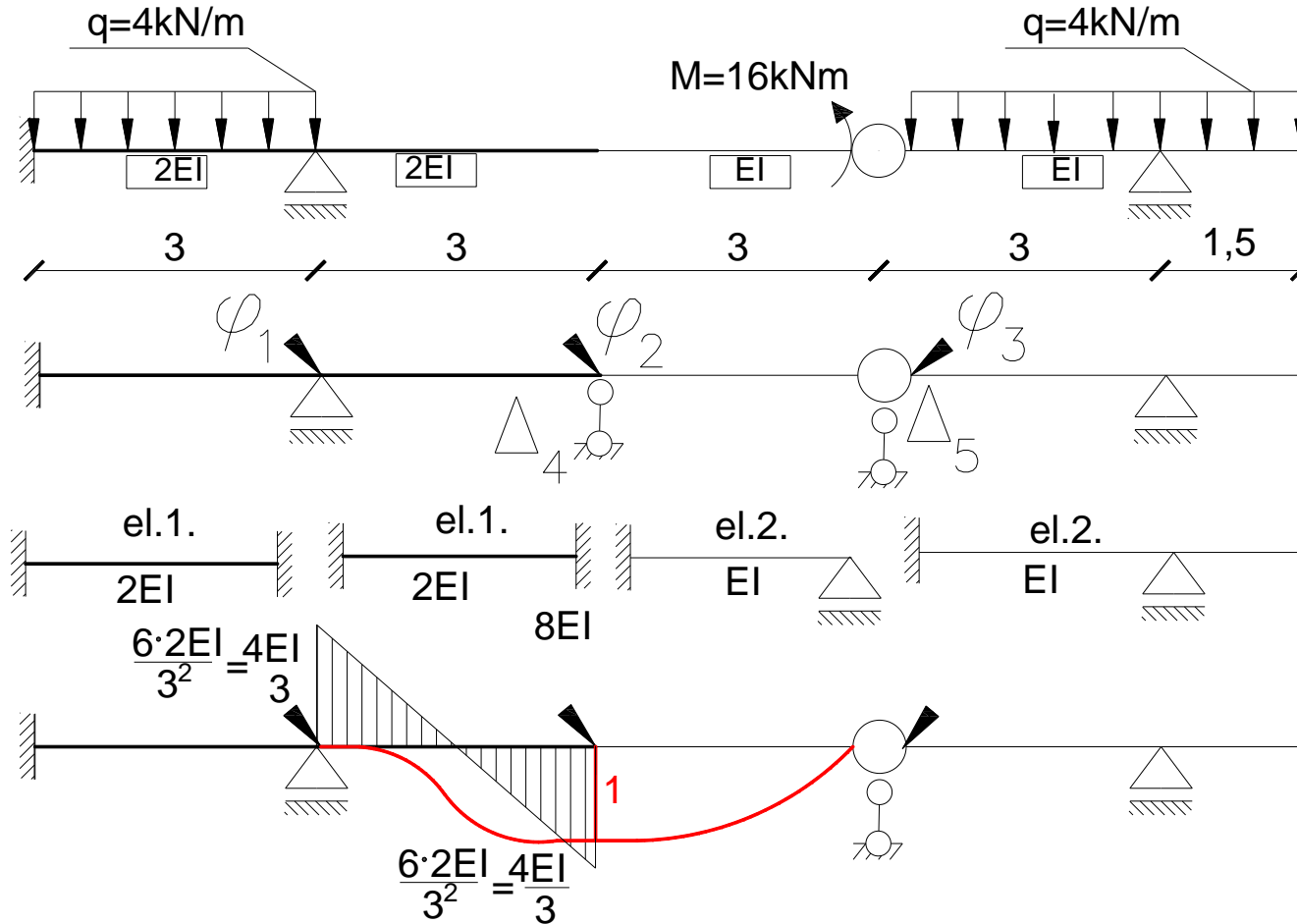

Stan  $\Delta_4=1$

23	<p> <math>\Delta_{ik} = f</math>  <math>R_i</math>  <math>R_k</math>  <math>M_i</math> </p>	$3 \frac{EJ}{l^2}$	0
----	---	--------------------	---

# Wykresy jednostkowe:

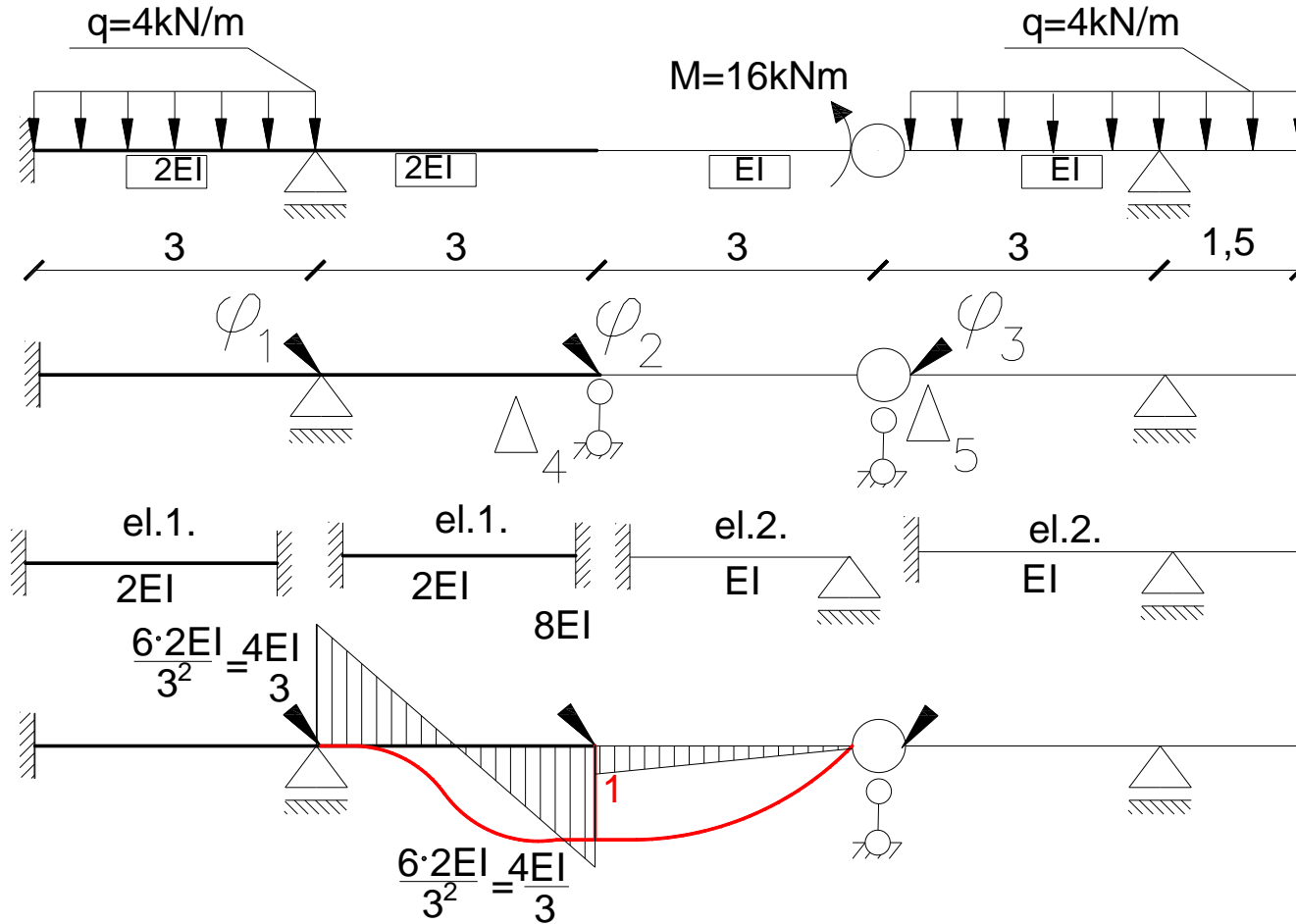

Stan  $\Delta_4=1$

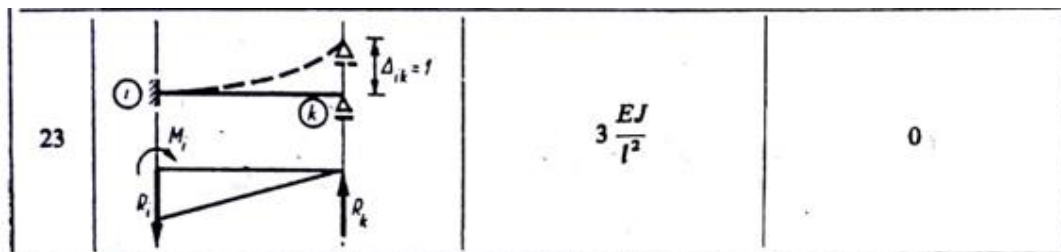

# Wykresy jednostkowe:

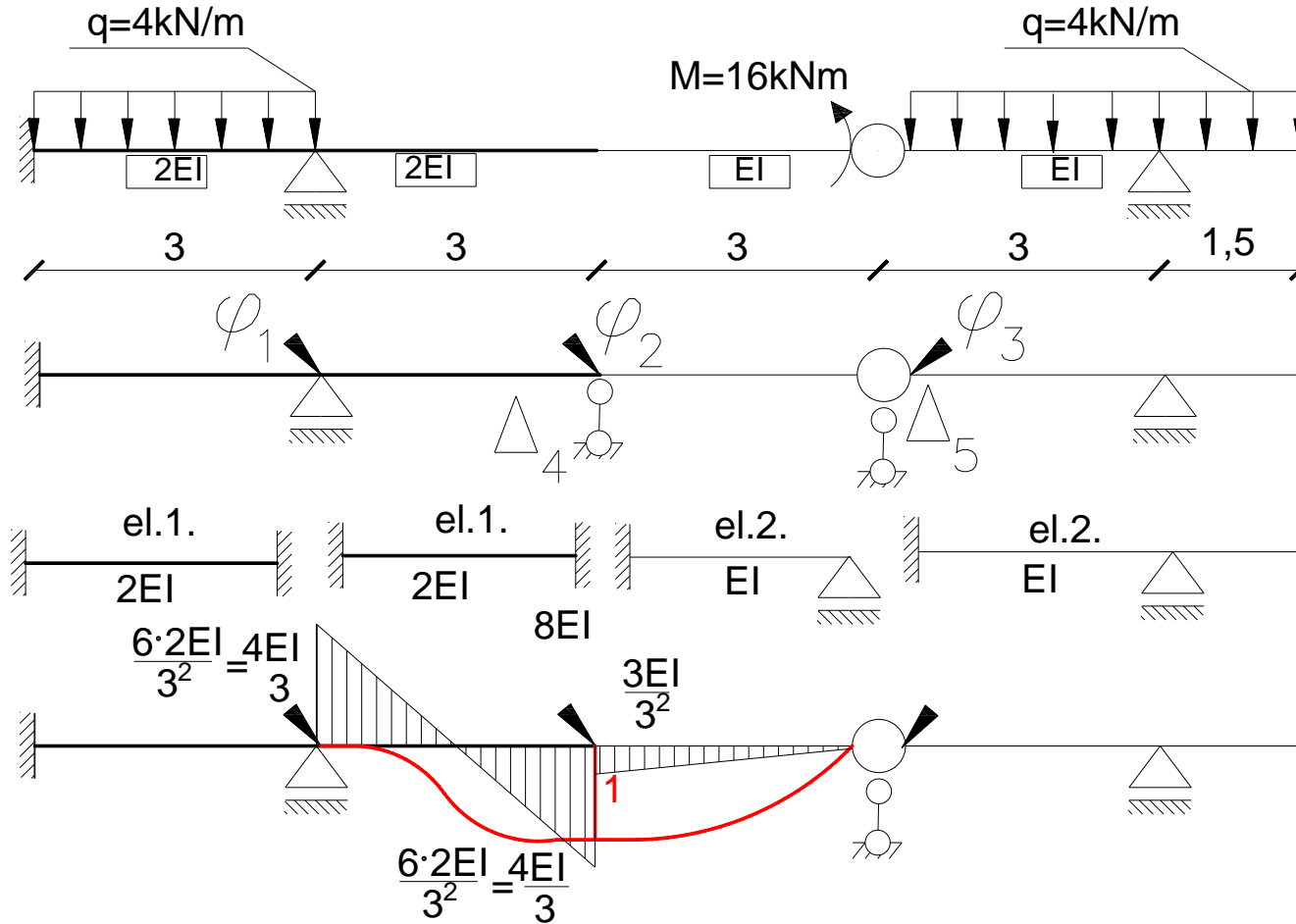

Stan  $\Delta_4=1$

23		$3 \frac{EJ}{l^2}$	0
----	--	--------------------	---

# Wykresy jednostkowe:

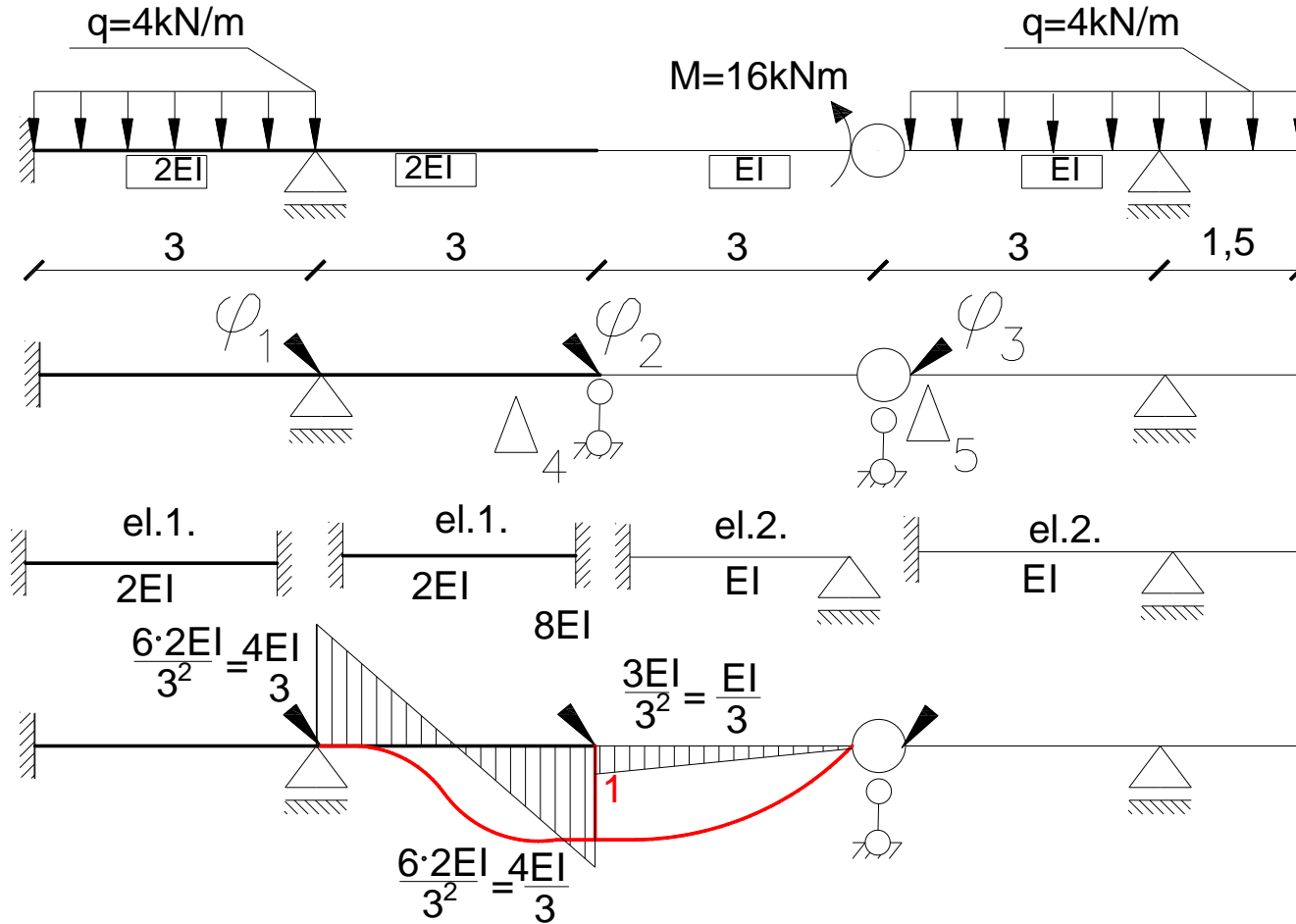

Stan  $\Delta_4=1$

23		$3 \frac{EJ}{l^2}$	0
----	--	--------------------	---

# Wykresy jednostkowe:

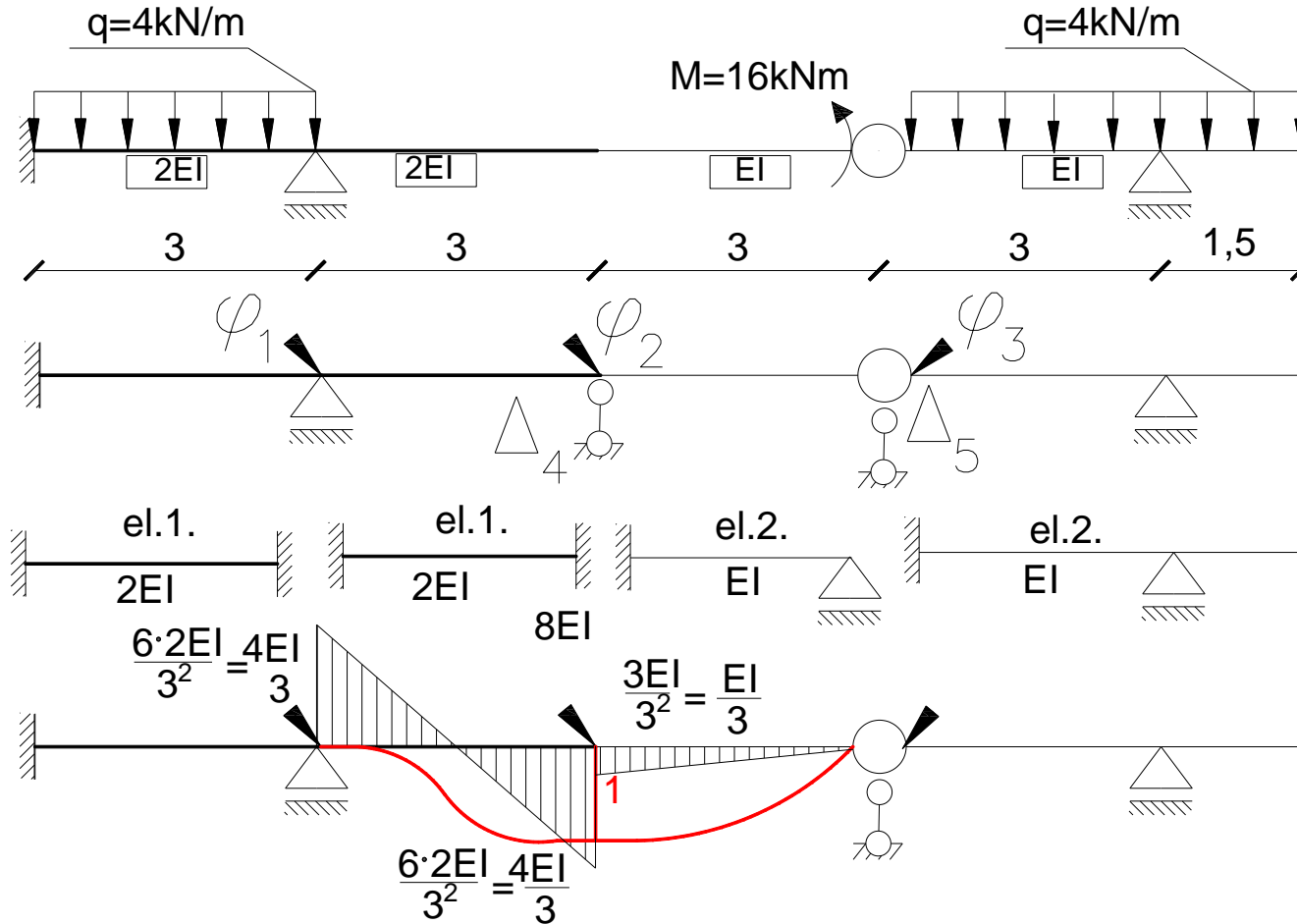

Stan  $\Delta_4 = 1$

# Wykresy jednostkowe:

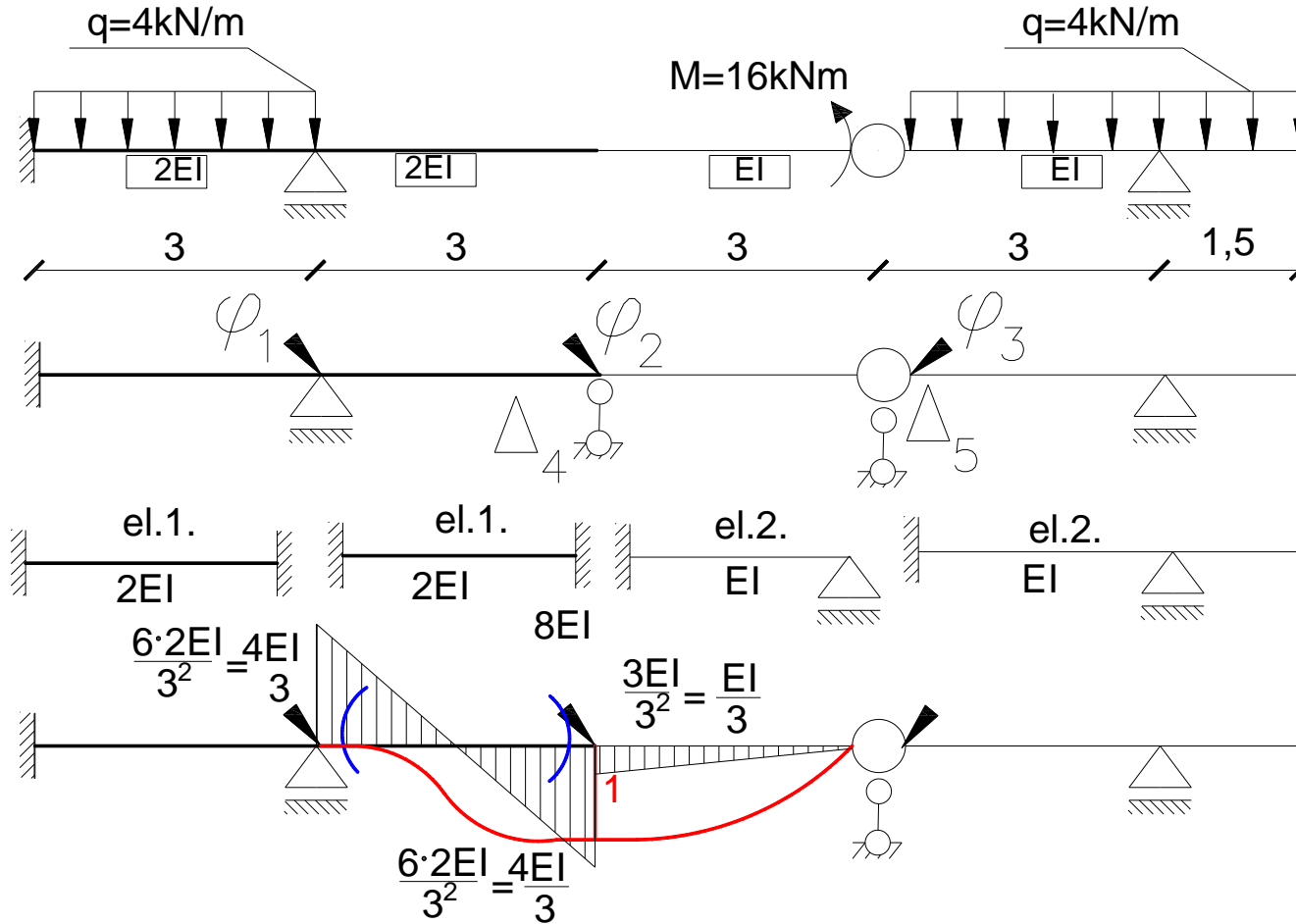

Stan  $\Delta_4=1$

# Wykresy jednostkowe:

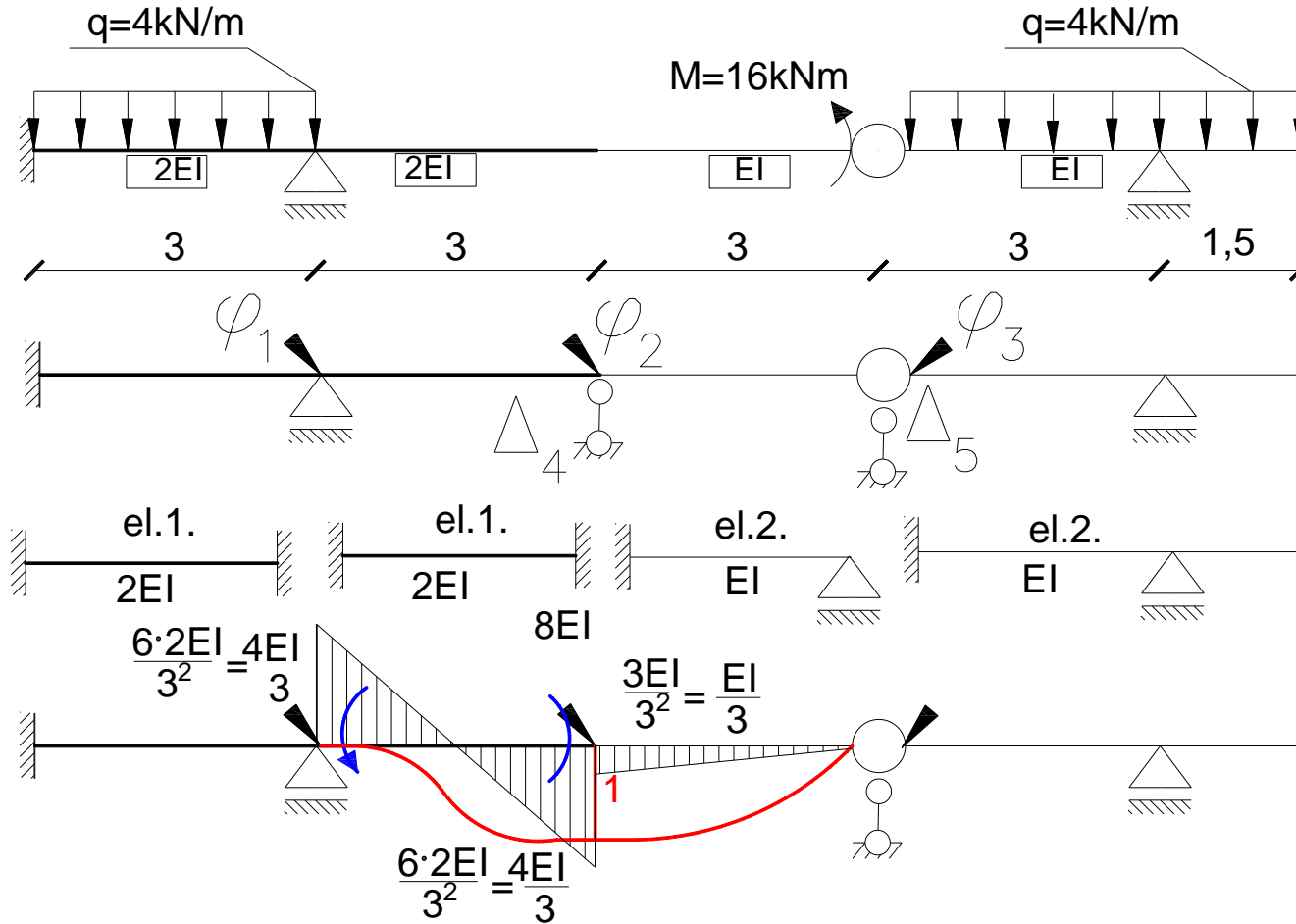

Stan  $\Delta_4=1$



# Wykresy jednostkowe:

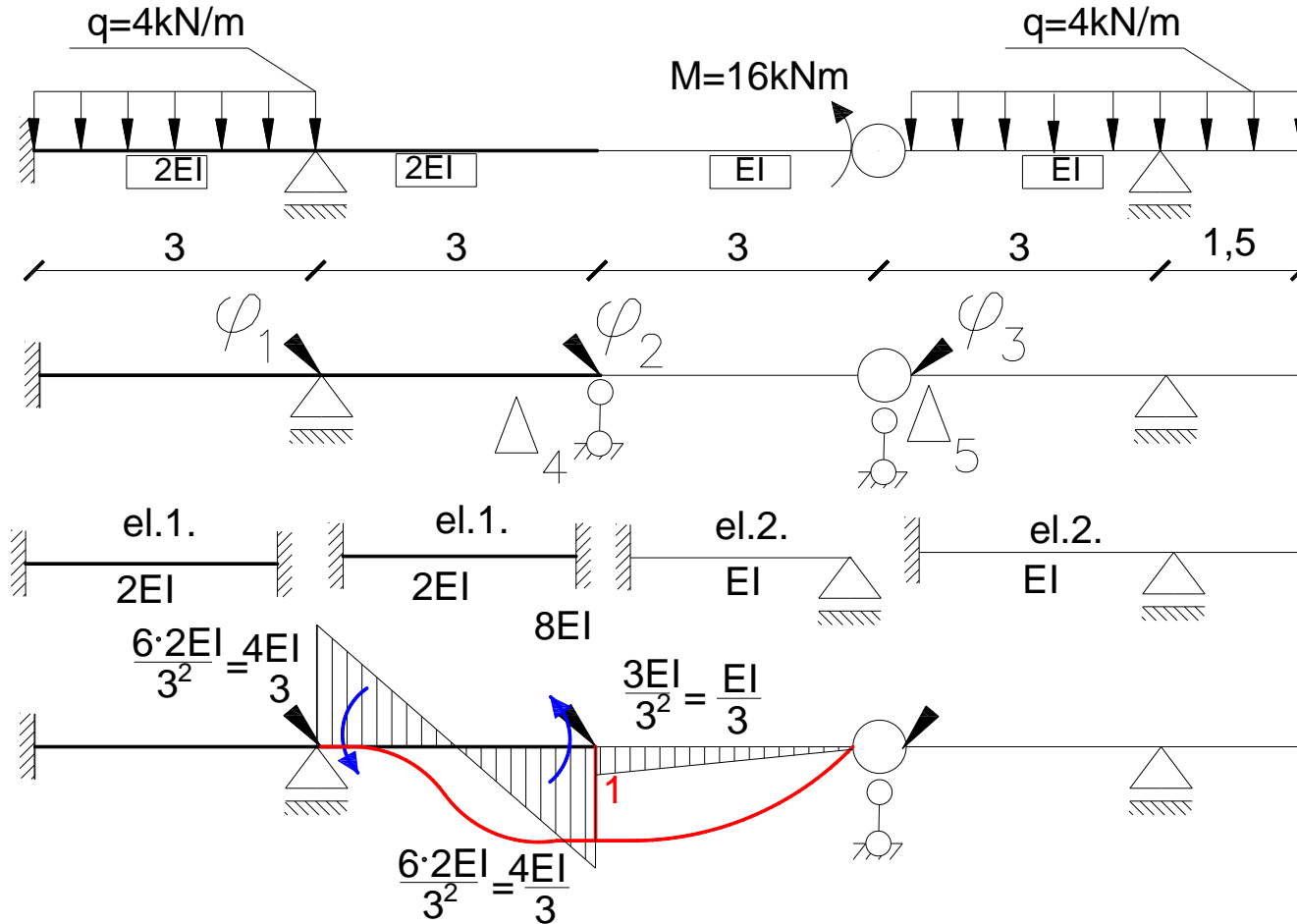

Stan  $\Delta_4=1$

# Wykresy jednostkowe:

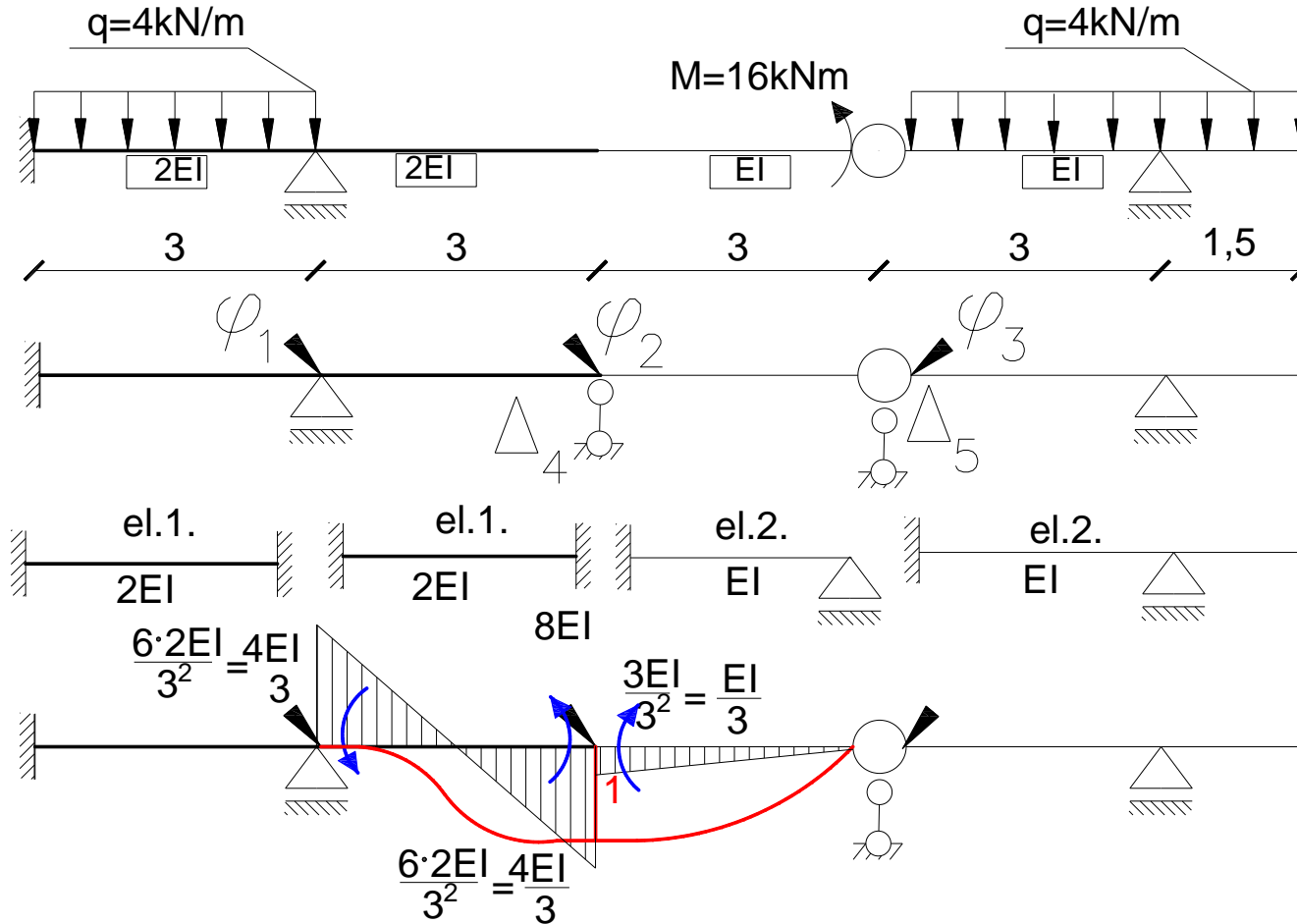

Stan  $\Delta_4=1$

# Wykresy jednostkowe:

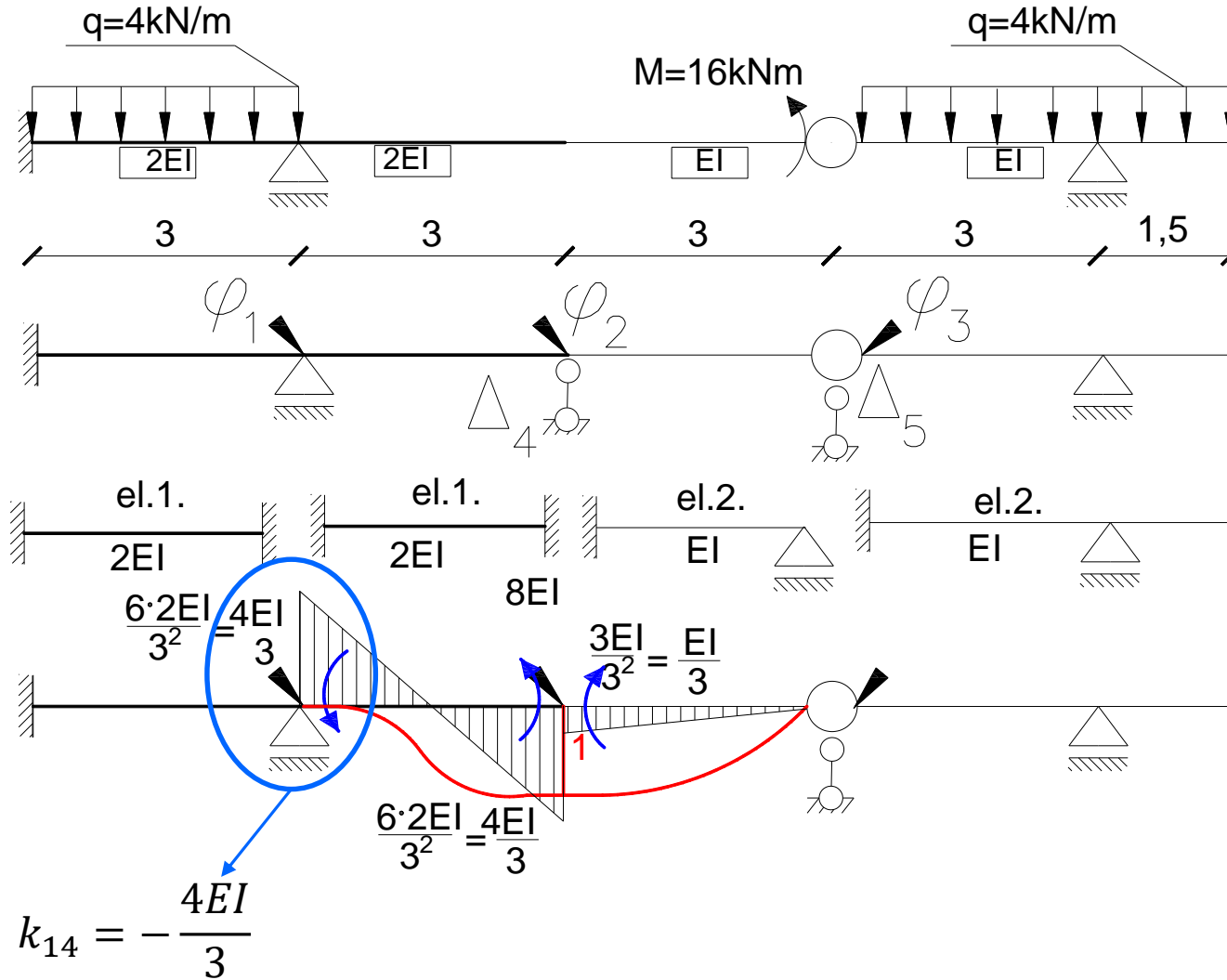

Stan  $\Delta_4=1$

# Wykresy jednostkowe:

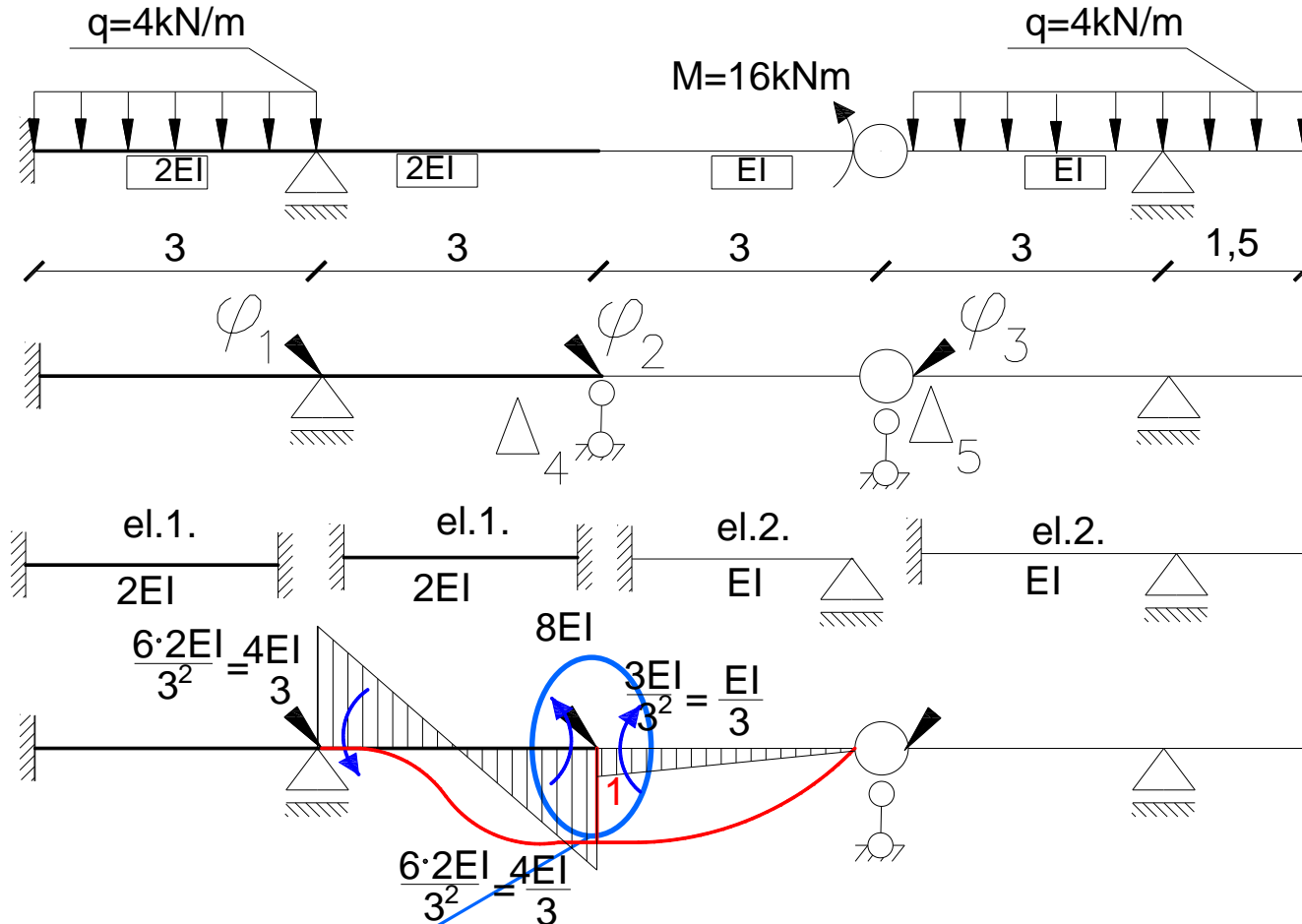

Stan  $\Delta_4=1$

$$k_{14} = -\frac{4EI}{3}$$

$$k_{24} = -\frac{4EI}{3} + \frac{EI}{3} = -EI$$

# Wykresy jednostkowe:

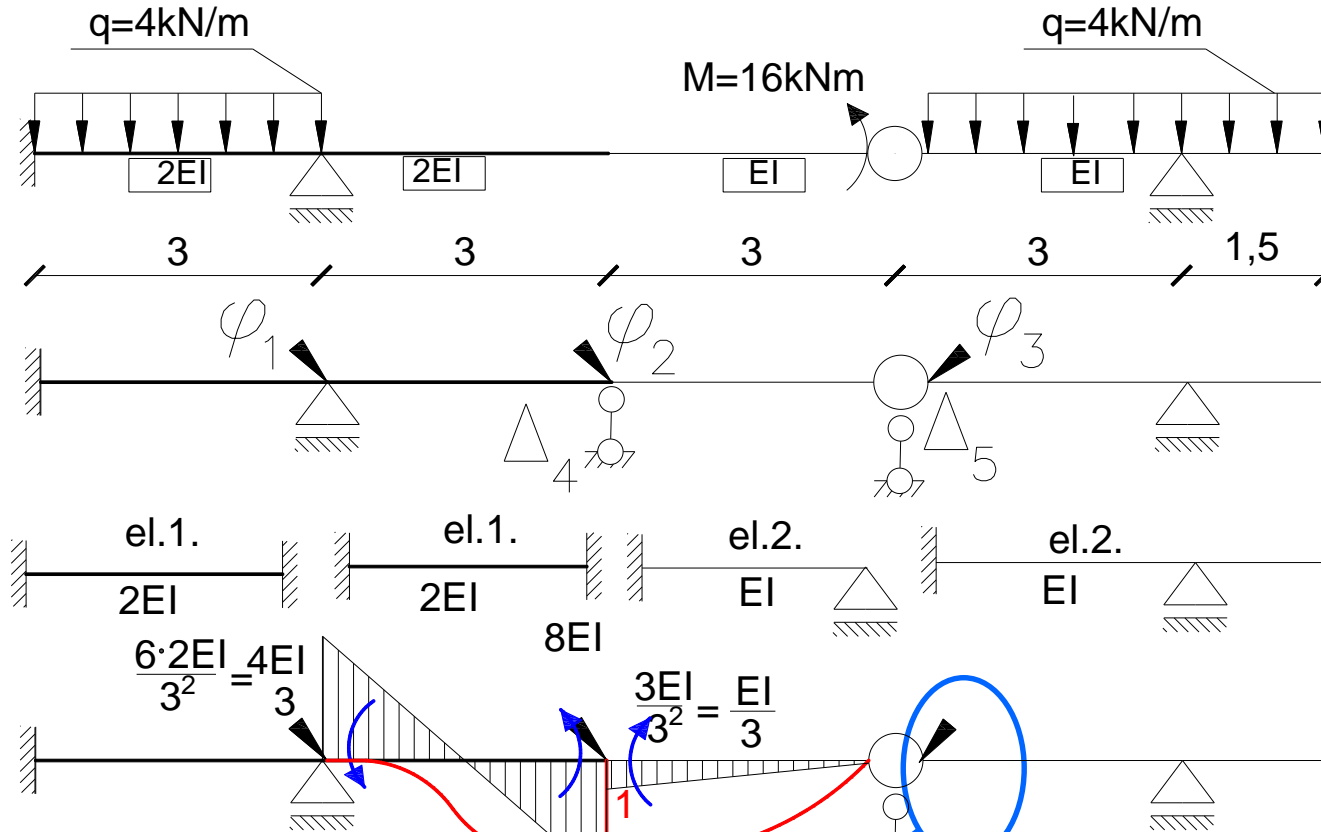

Stan  $\Delta_4=1$

$$k_{14} = -\frac{4EI}{3}$$

$$k_{34} = 0$$

$$k_{24} = -\frac{4EI}{3} + \frac{EI}{3} = -EI$$

# Wykresy jednostkowe:

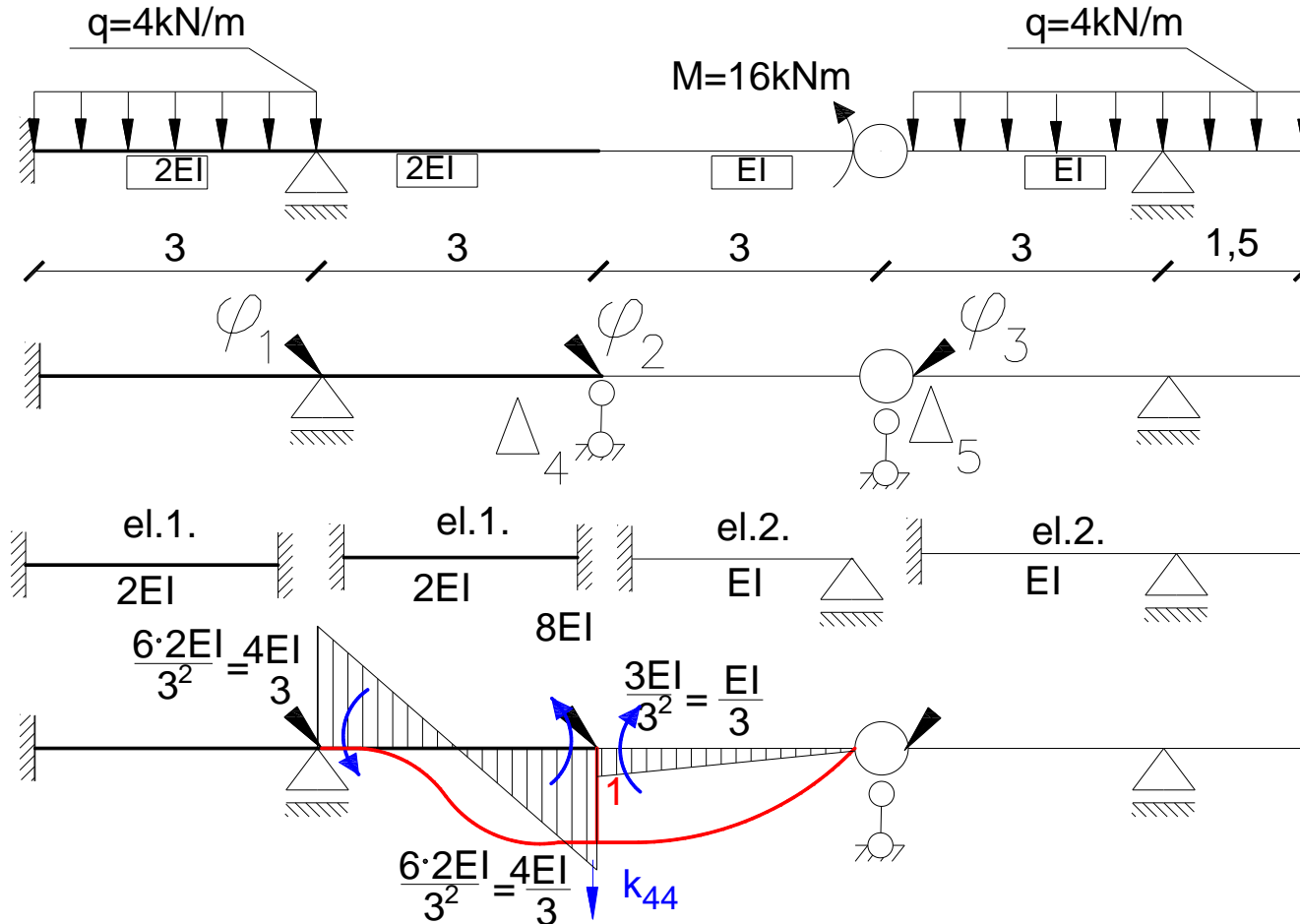

Stan  $\Delta_4=1$

$$k_{14} = -\frac{4EI}{3}$$

$$k_{34} = 0$$

$$k_{24} = -\frac{4EI}{3} + \frac{EI}{3} = -EI$$

# Wykresy jednostkowe:

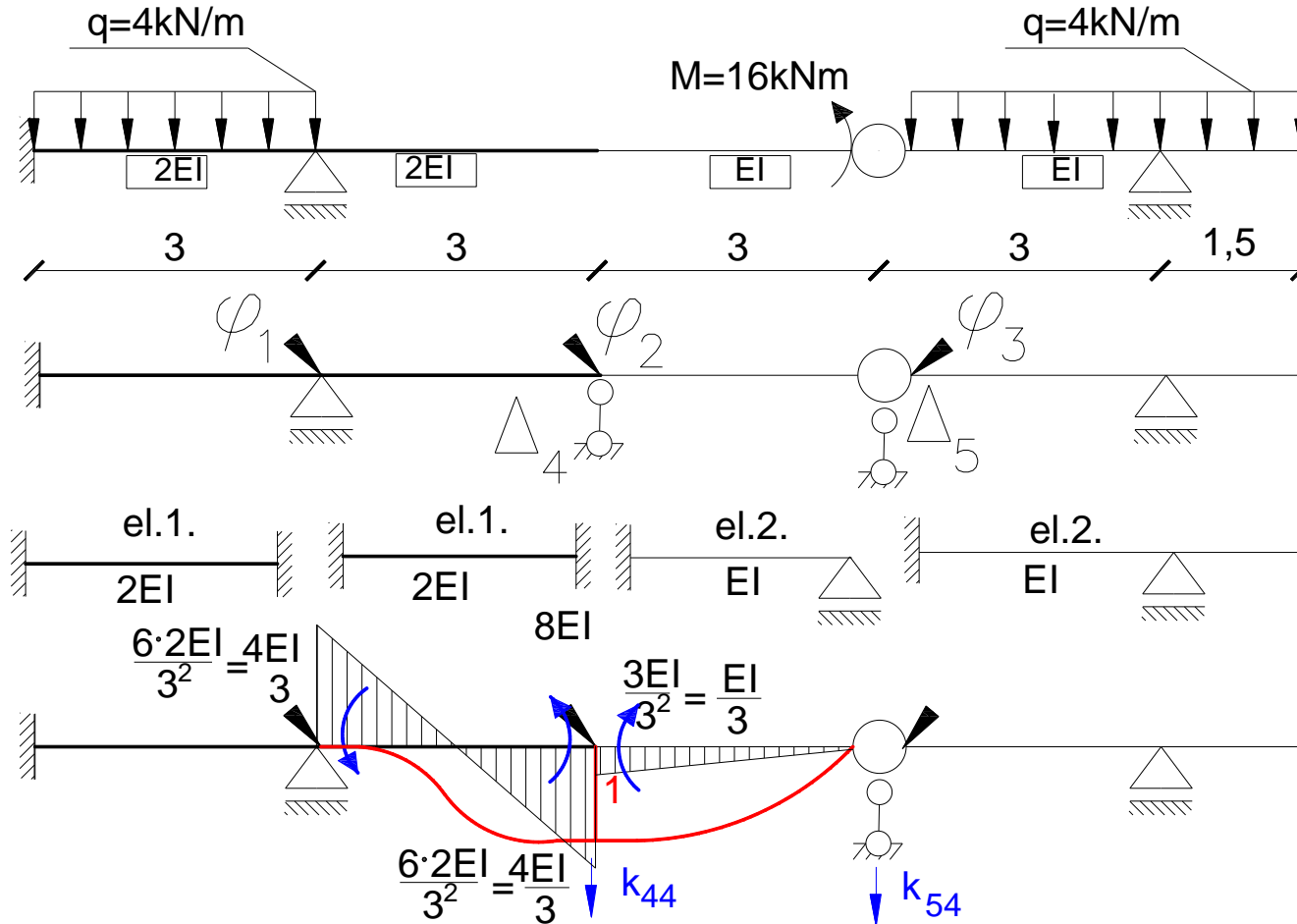

Stan  $\Delta_4=1$

$$k_{14} = -\frac{4EI}{3}$$

$$k_{34} = 0$$

$$k_{24} = -\frac{4EI}{3} + \frac{EI}{3} = -EI$$

# Wykresy jednostkowe:

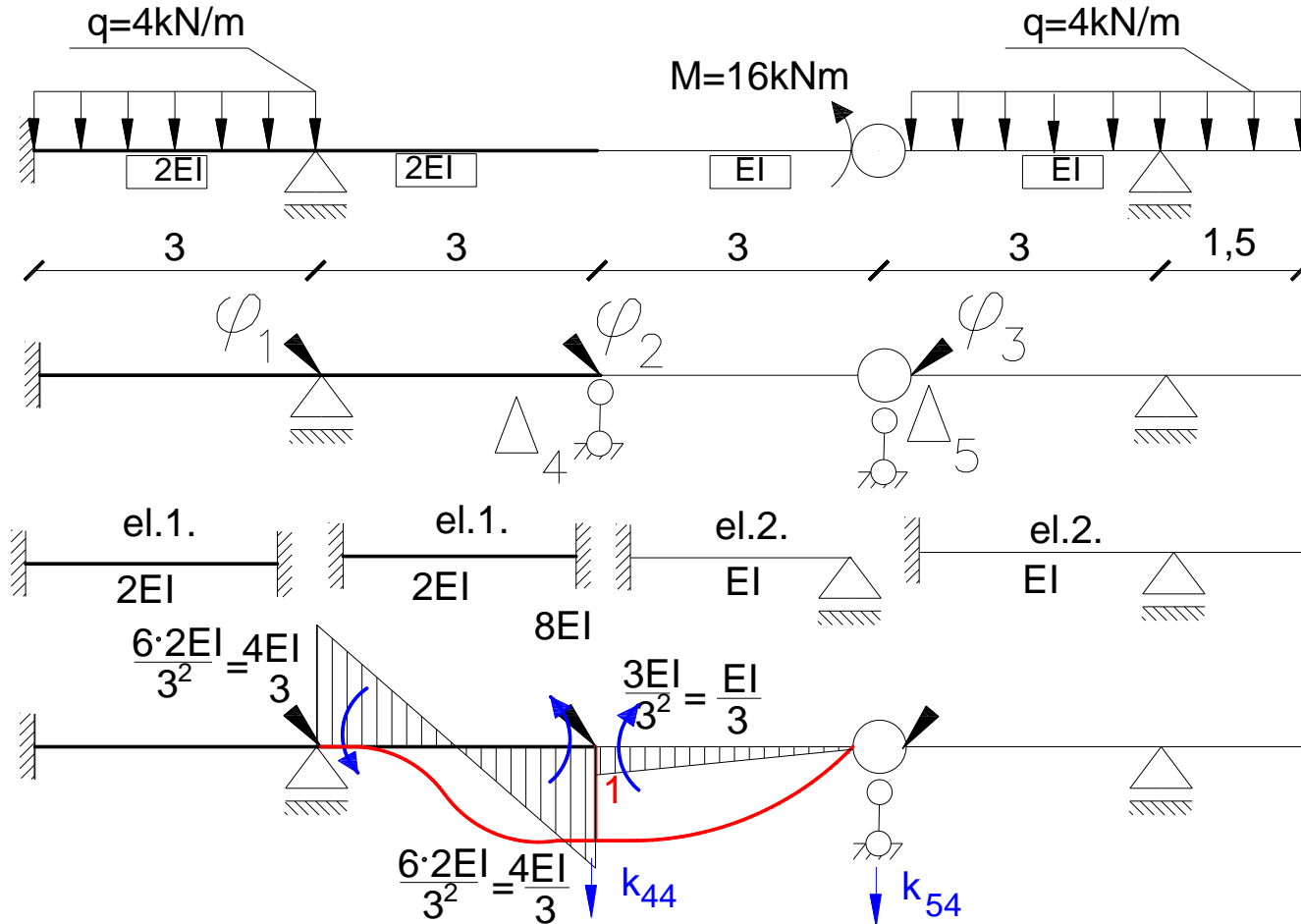

Stan  $\Delta_4=1$

$$k_{14} = -\frac{4EI}{3}$$

$$k_{34} = 0$$

$$k_{24} = -\frac{4EI}{3} + \frac{EI}{3} = -EI$$

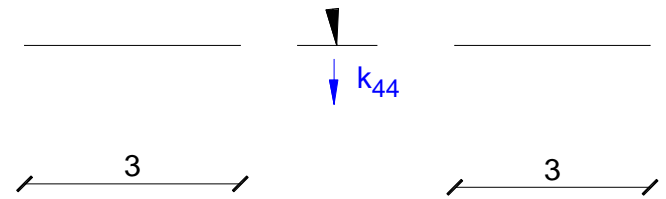



# Wykresy jednostkowe:

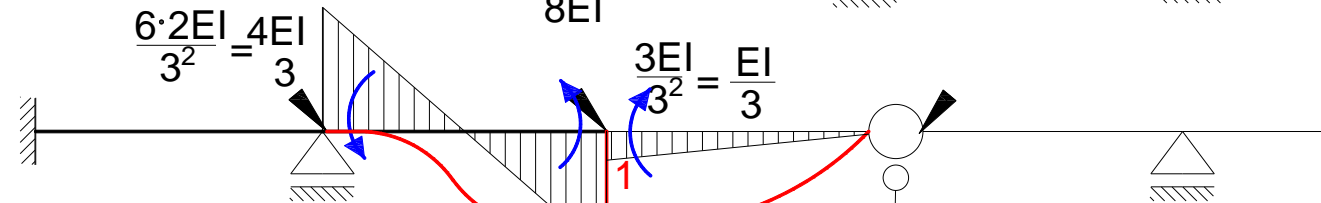
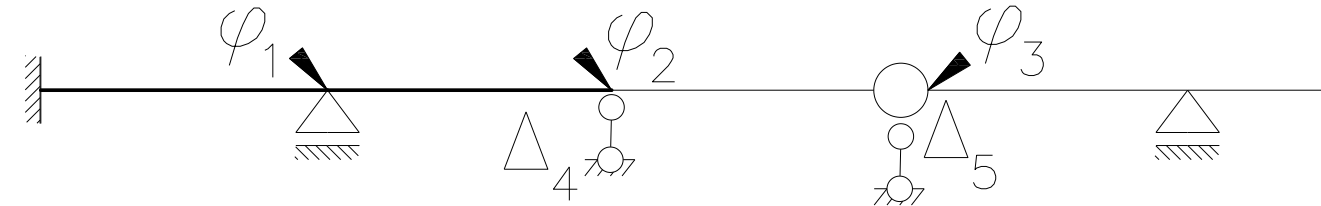
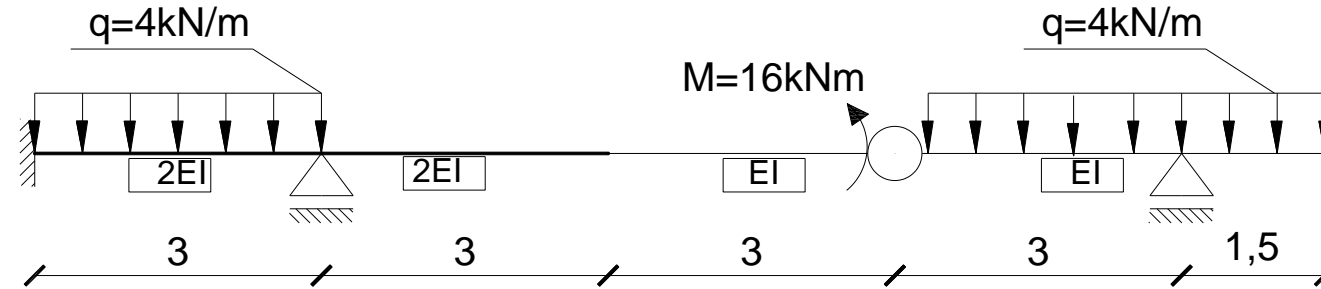

Stan  $\Delta_4=1$

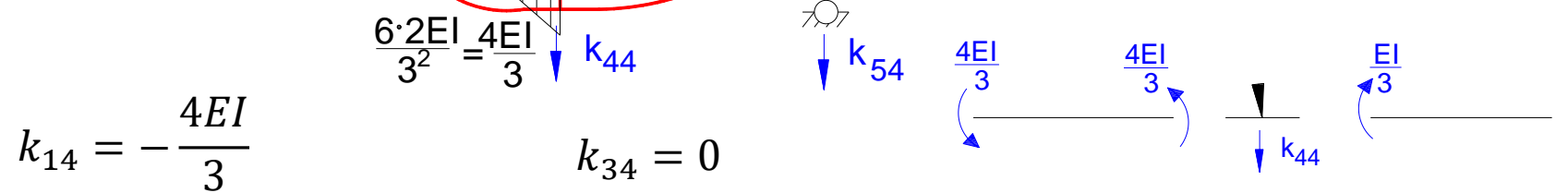

$$k_{14} = -\frac{4EI}{3}$$

$$k_{34} = 0$$

$$k_{24} = -\frac{4EI}{3} + \frac{EI}{3} = -EI$$

# Wykresy jednostkowe:

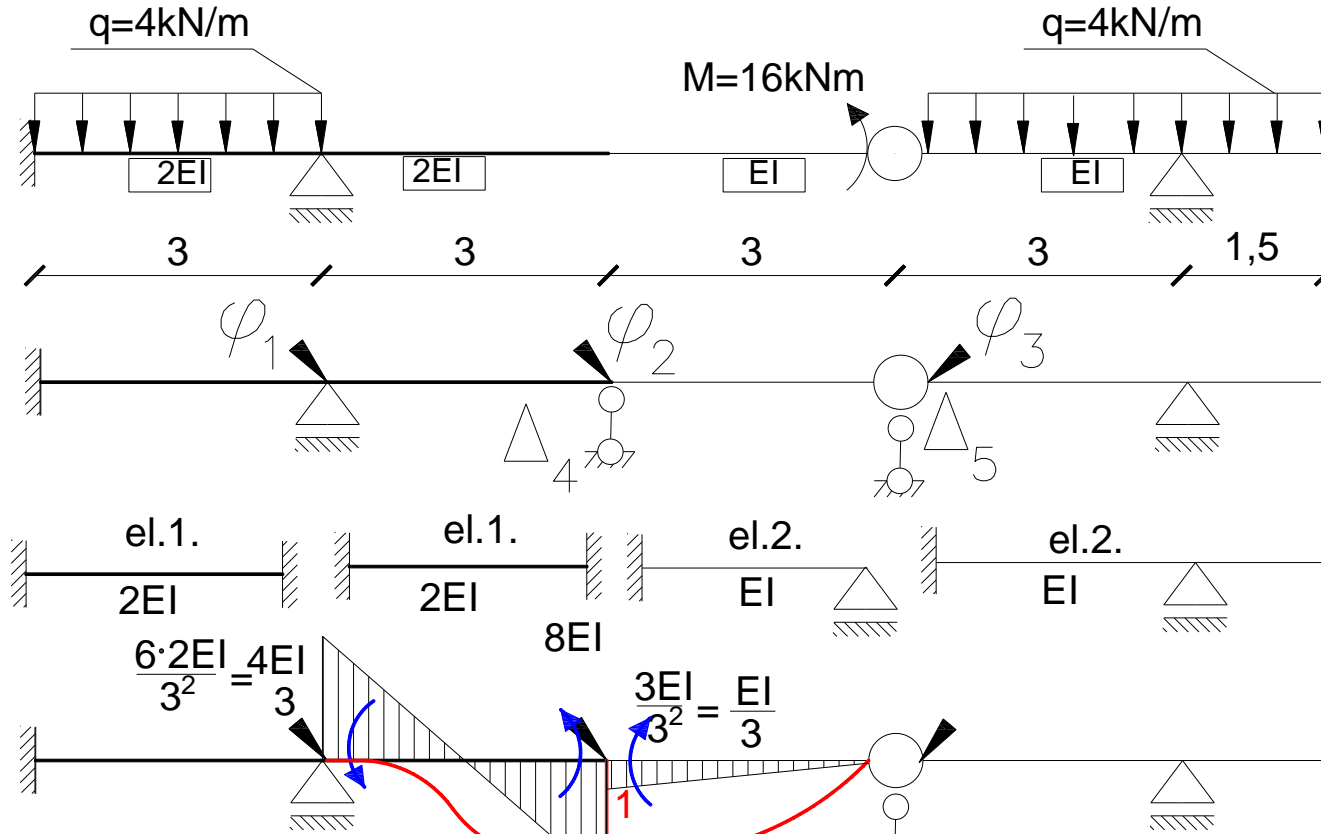

Stan  $\Delta_4=1$

$$k_{14} = -\frac{4EI}{3}$$

$$k_{34} = 0$$

$$k_{24} = -\frac{4EI}{3} + \frac{EI}{3} = -EI$$

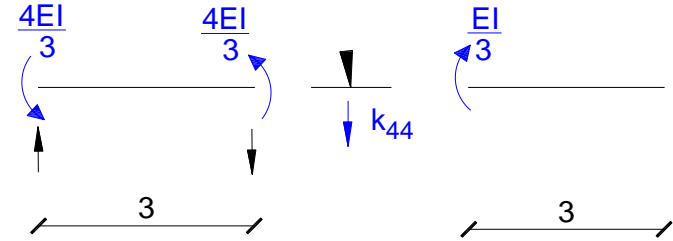

# Wykresy jednostkowe:

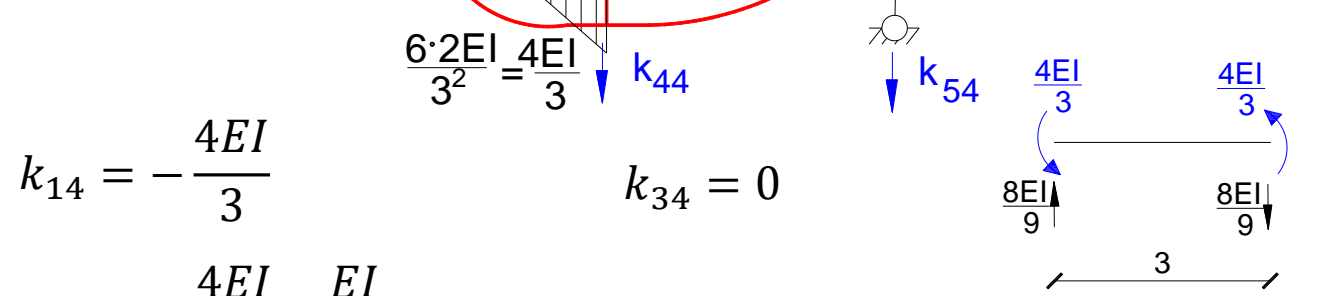
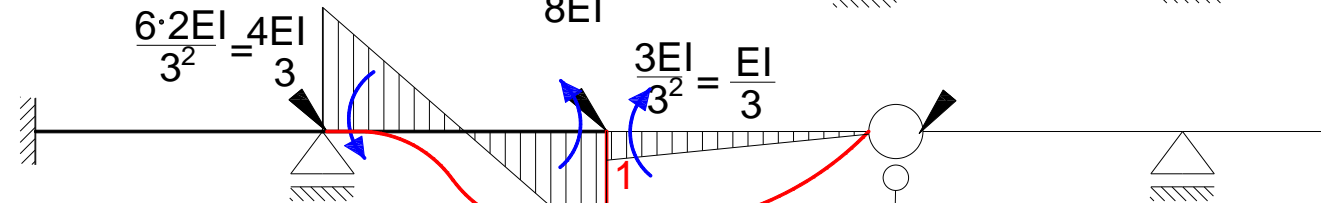
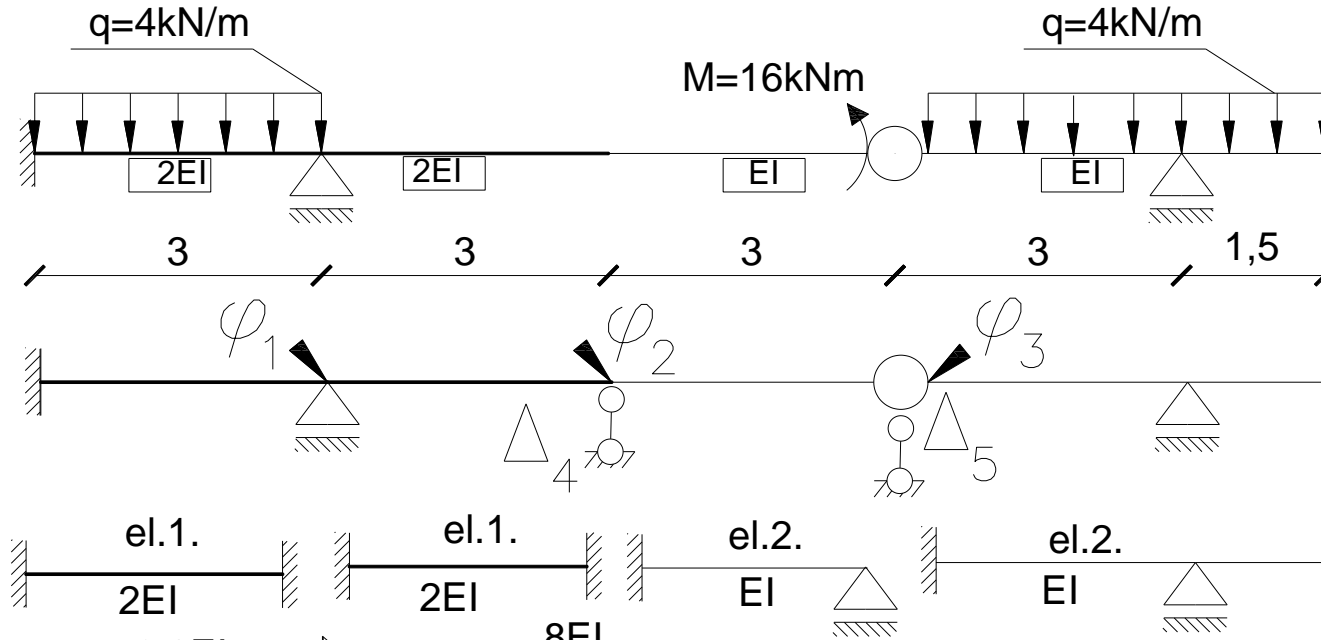

Stan  $\Delta_4=1$

$$k_{14} = -\frac{4EI}{3}$$

$$k_{34} = 0$$

$$k_{24} = -\frac{4EI}{3} + \frac{EI}{3} = -EI$$

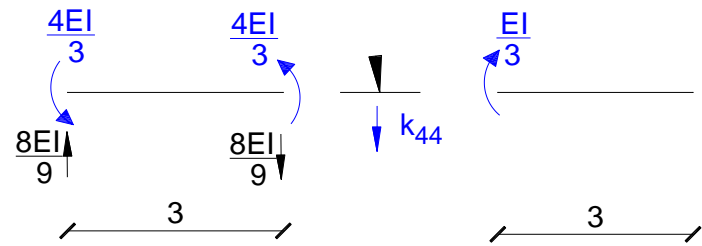

# Wykresy jednostkowe:

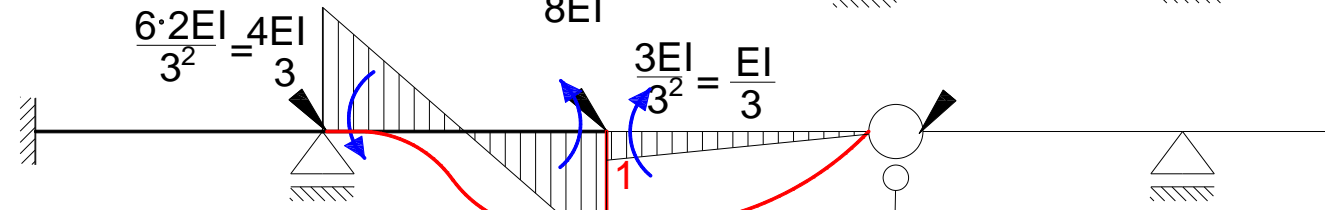
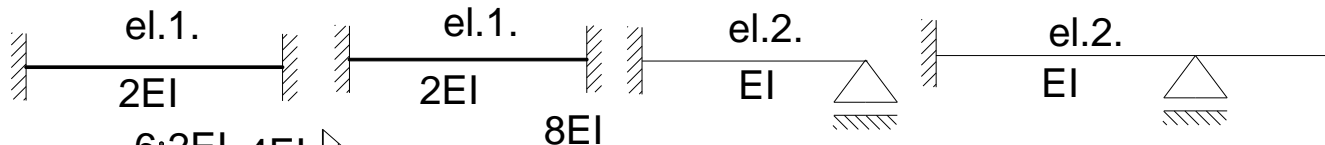
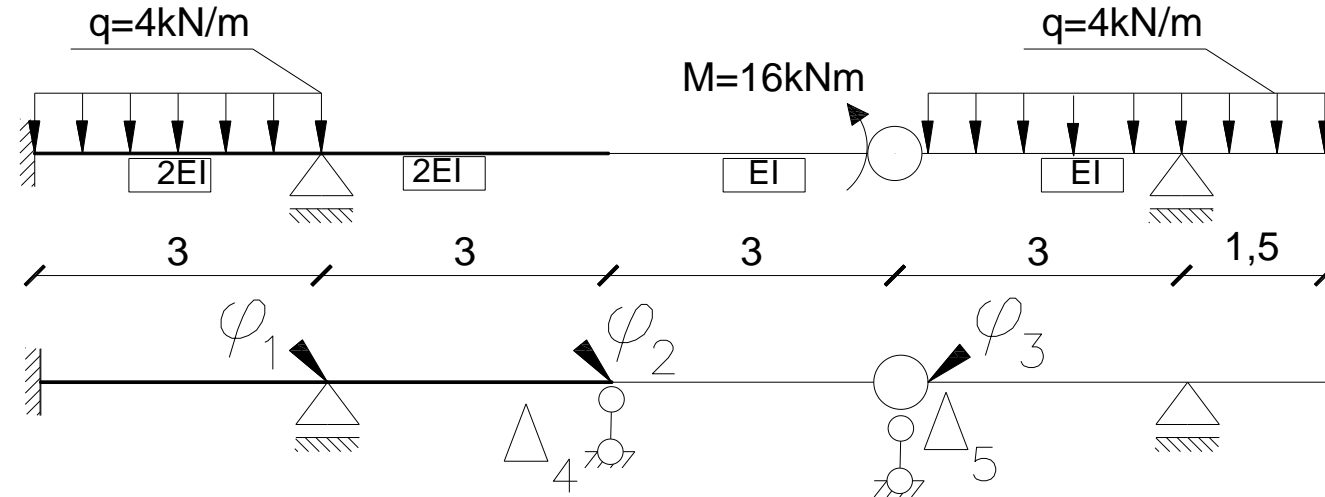

Stan  $\Delta_4=1$

$$k_{14} = -\frac{4EI}{3}$$

$$k_{34} = 0$$

$$k_{24} = -\frac{4EI}{3} + \frac{EI}{3} = -EI$$

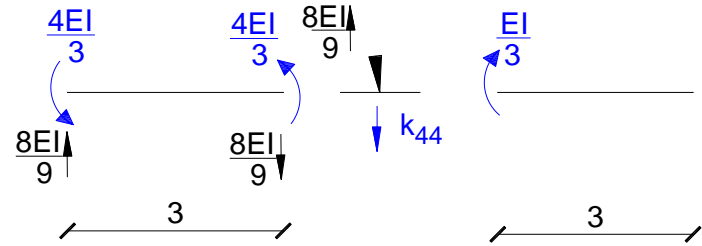

# Wykresy jednostkowe:

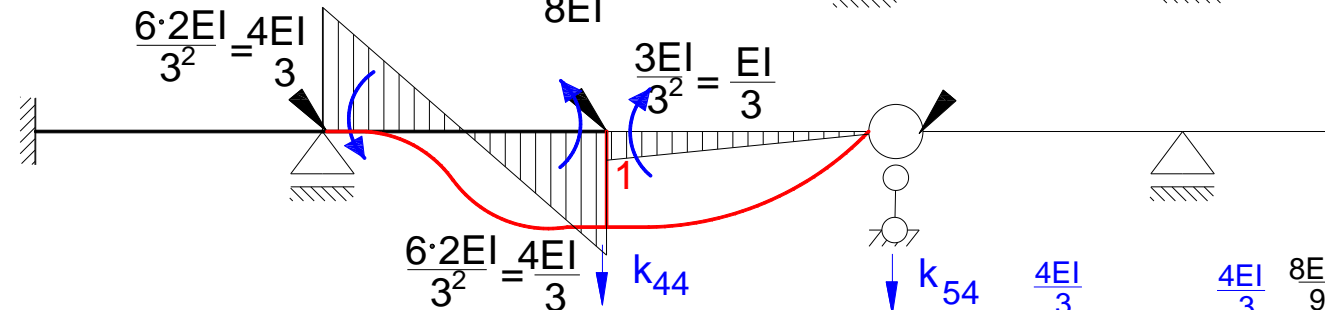
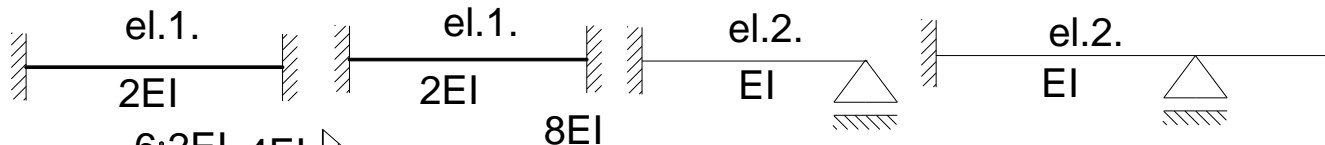
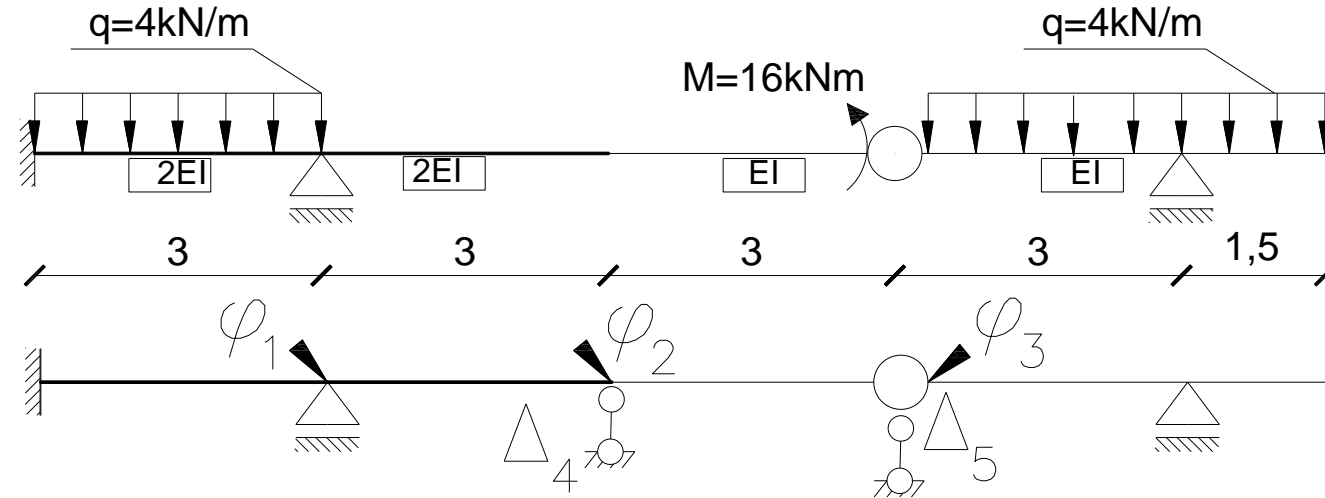

Stan  $\Delta_4=1$

$$k_{14} = -\frac{4EI}{3}$$

$$k_{34} = 0$$

$$k_{24} = -\frac{4EI}{3} + \frac{EI}{3} = -EI$$

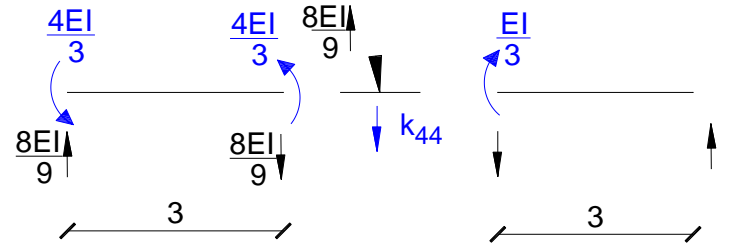

# Wykresy jednostkowe:

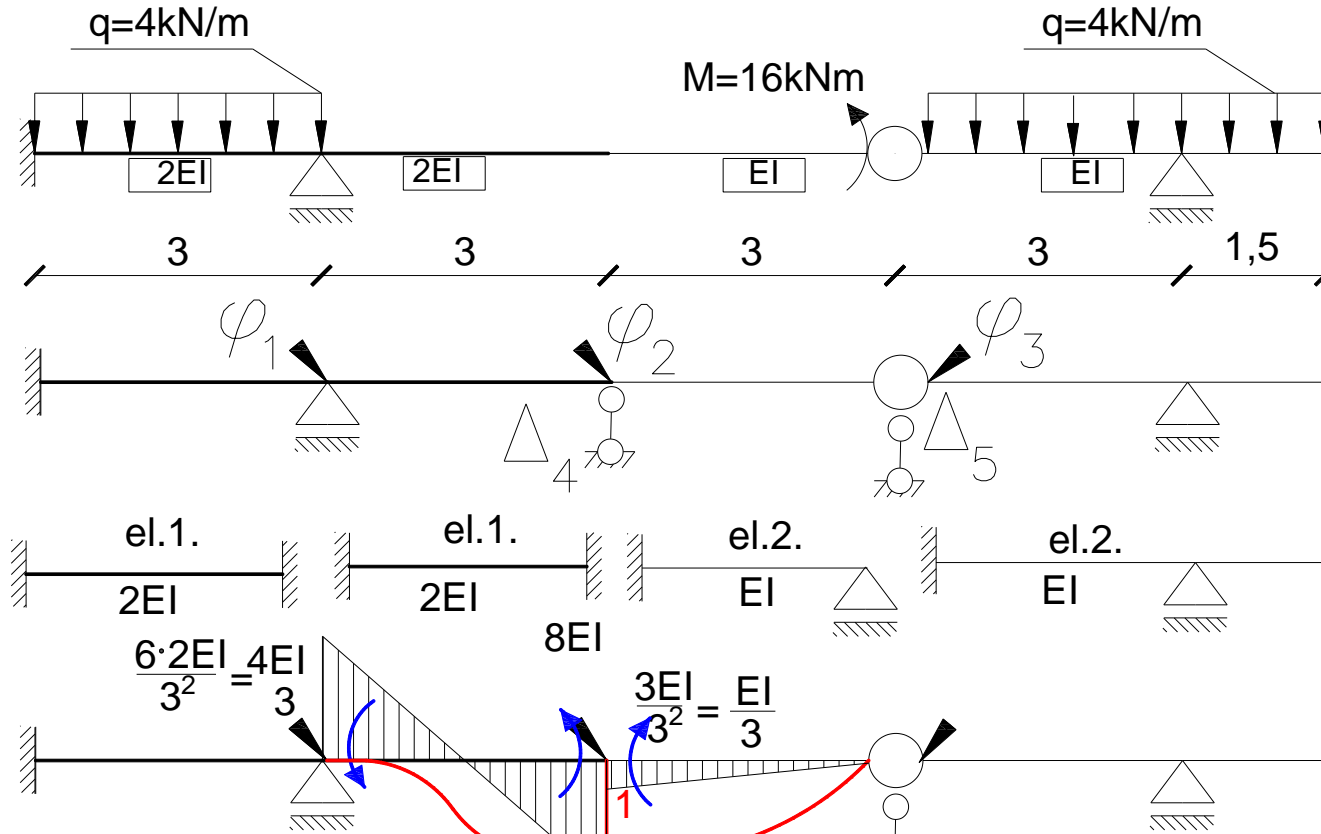

Stan  $\Delta_4=1$

$$k_{14} = -\frac{4EI}{3}$$

$$k_{34} = 0$$

$$k_{24} = -\frac{4EI}{3} + \frac{EI}{3} = -EI$$

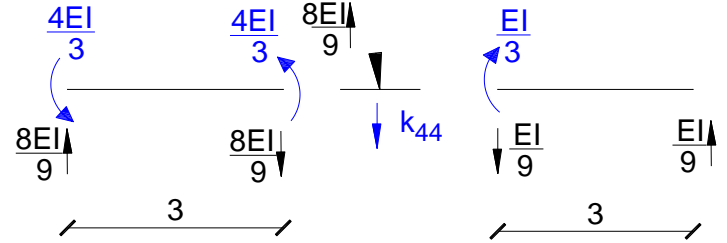

# Wykresy jednostkowe:

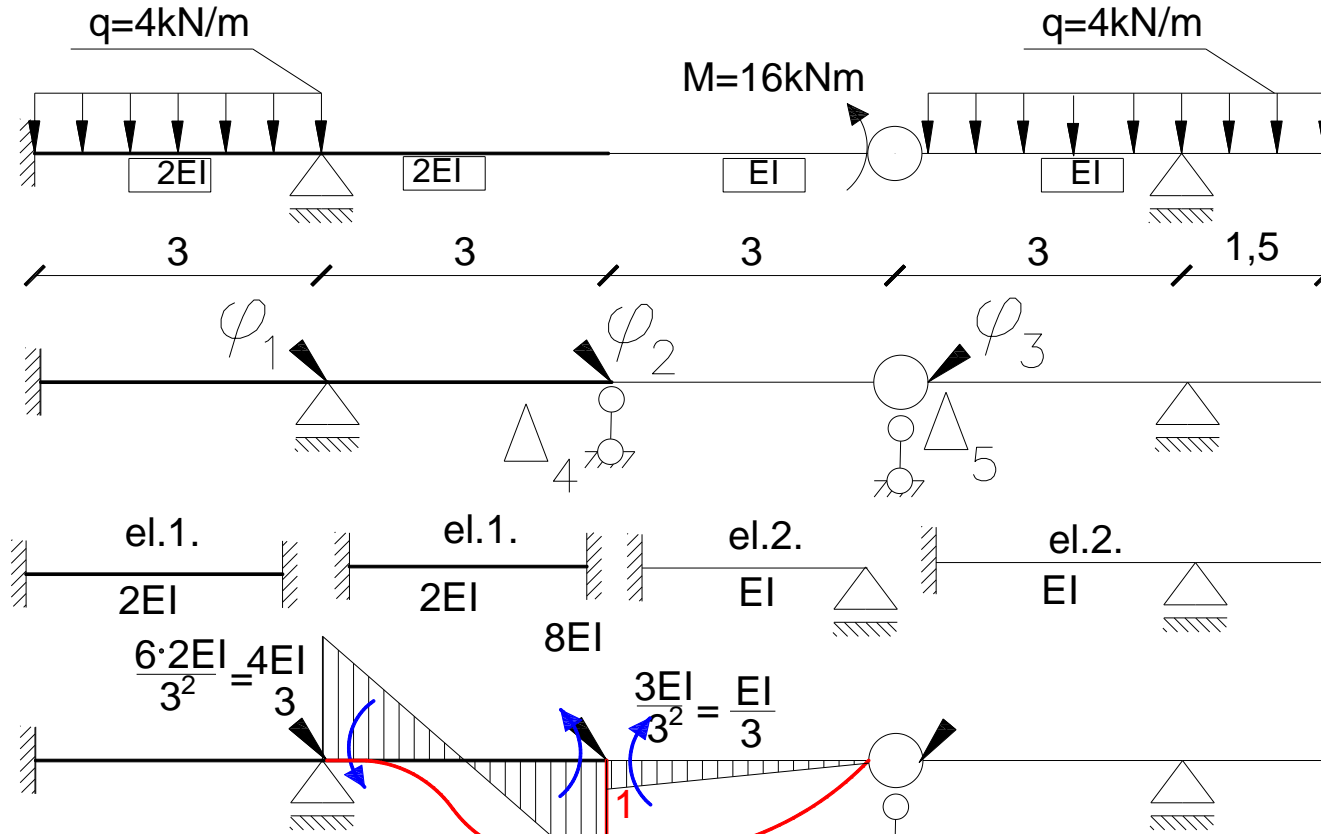

Stan  $\Delta_4=1$

$$k_{14} = -\frac{4EI}{3}$$

$$k_{34} = 0$$

$$k_{24} = -\frac{4EI}{3} + \frac{EI}{3} = -EI$$

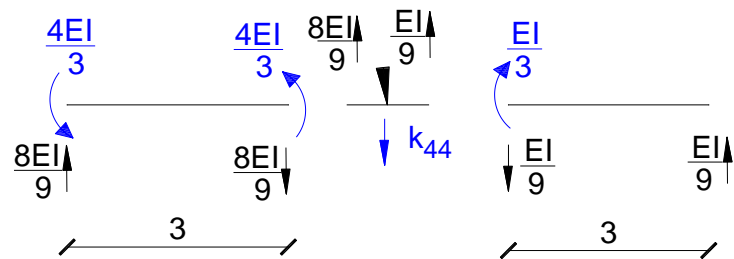

# Wykresy jednostkowe:

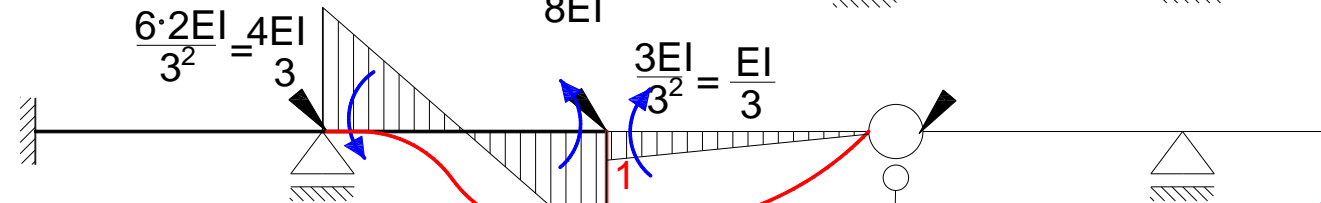
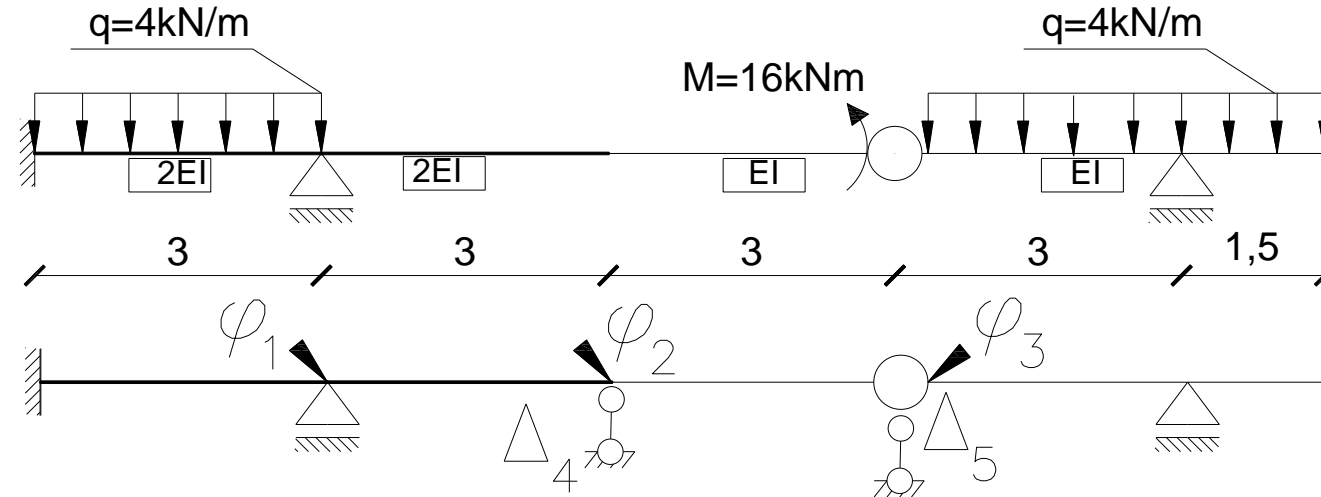

Stan  $\Delta_4=1$

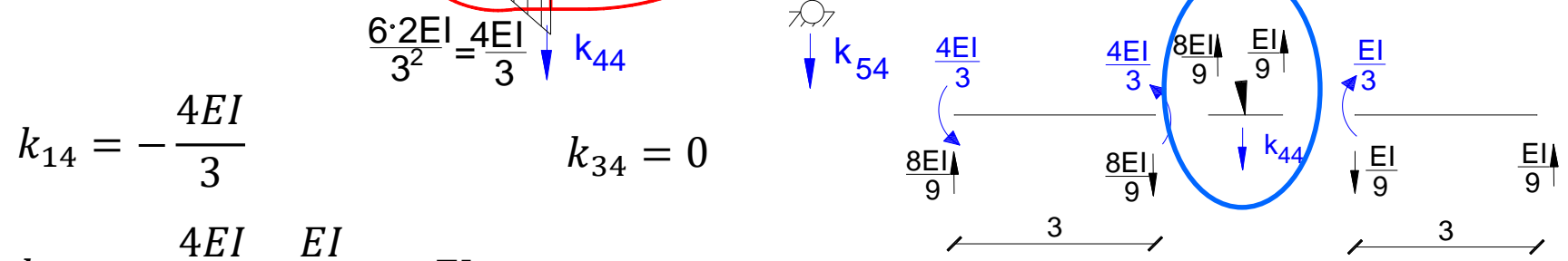



# Wykresy jednostkowe:

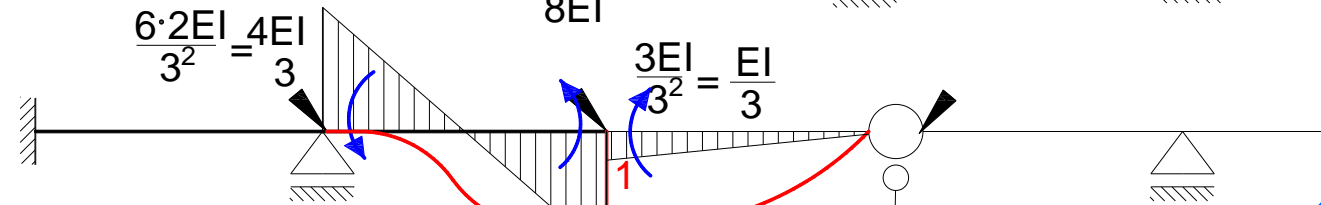
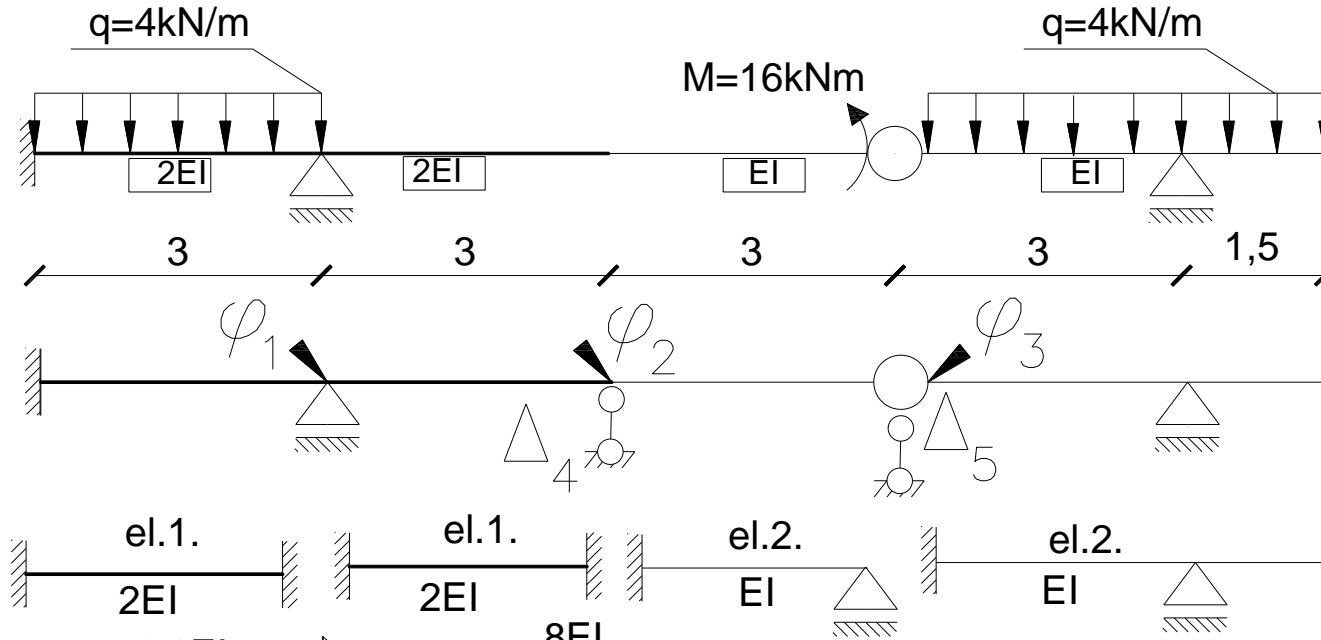

Stan  $\Delta_4=1$

$$k_{14} = -\frac{4EI}{3}$$

$$k_{34} = 0$$

$$k_{24} = -\frac{4EI}{3} + \frac{EI}{3} = -EI$$

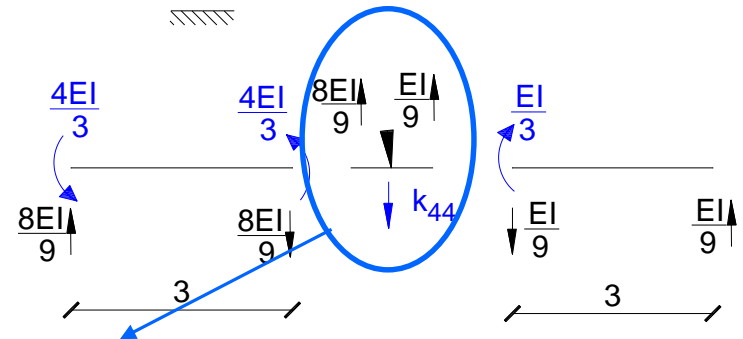

# Wykresy jednostkowe:

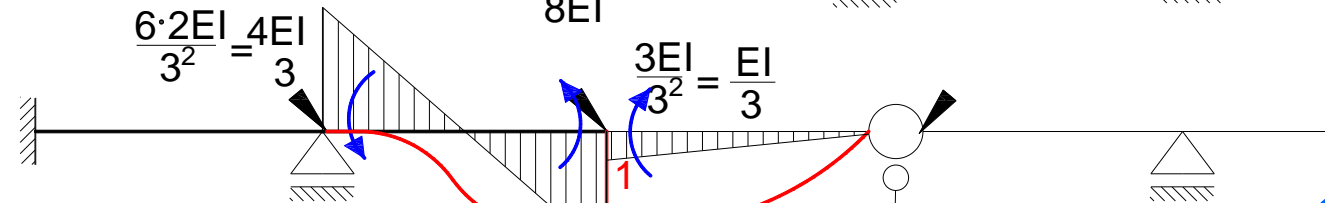
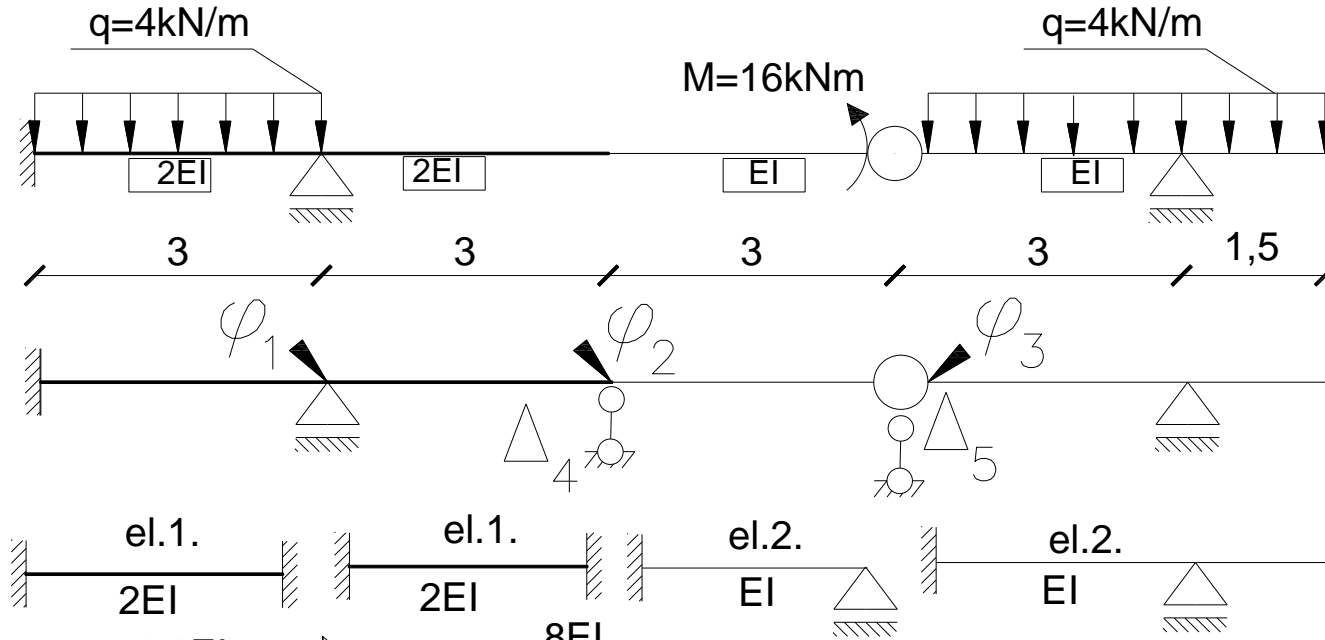

Stan  $\Delta_4=1$

$$k_{14} = -\frac{4EI}{3}$$

$$k_{34} = 0$$

$$k_{24} = -\frac{4EI}{3} + \frac{EI}{3} = -EI$$

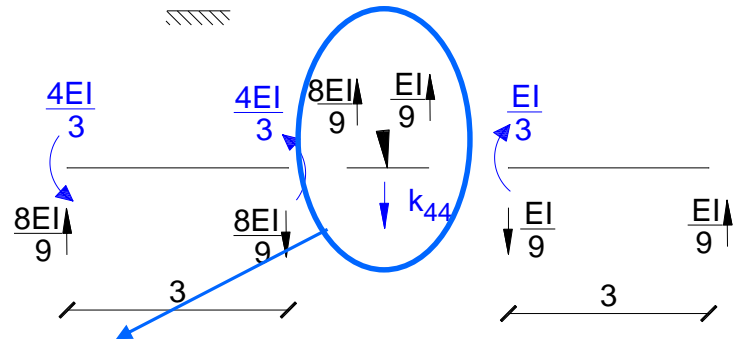

$$\sum R_y = \frac{EI}{9} + \frac{8EI}{9} - k_{44} = 0 \rightarrow k_{44} = EI \quad \text{dr inż. Hanna Weber}$$

# Wykresy jednostkowe:

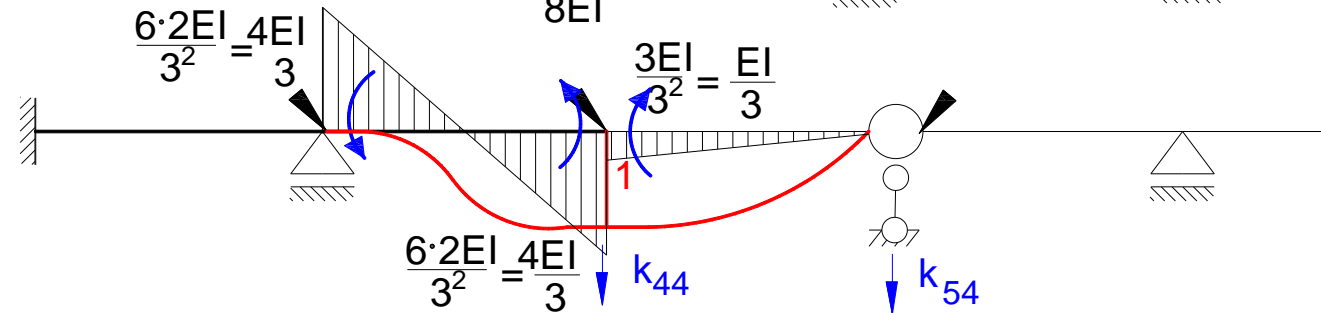
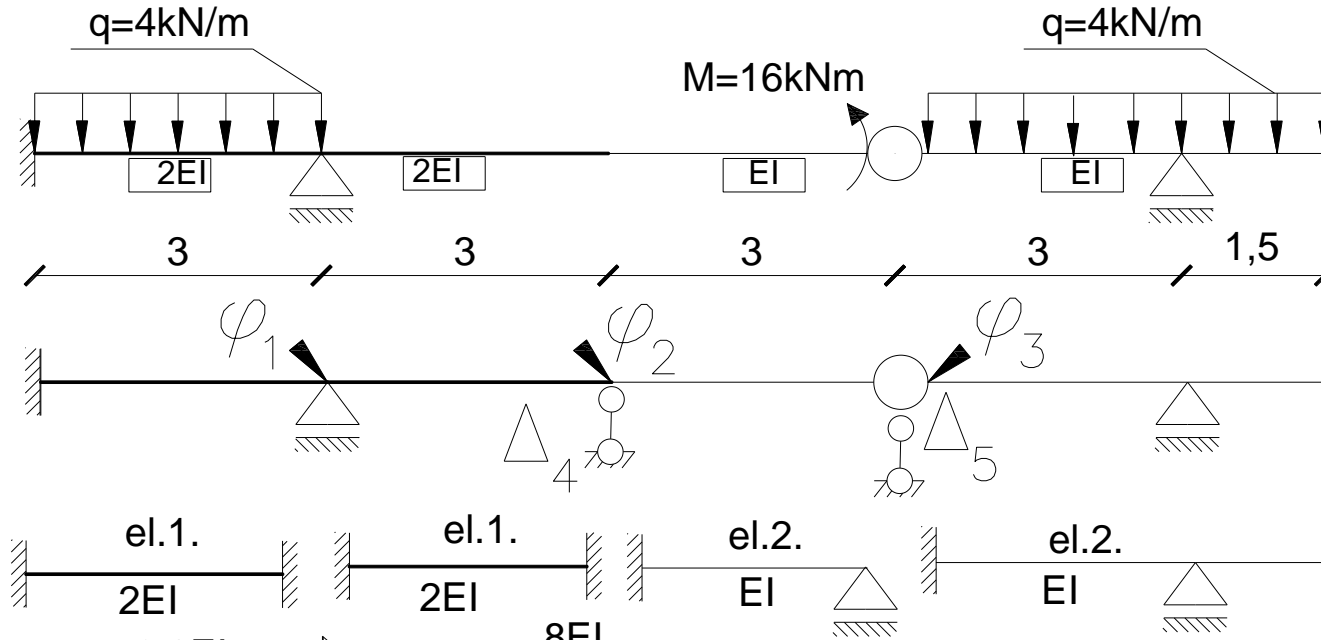

Stan  $\Delta_4=1$

$$k_{14} = -\frac{4EI}{3}$$

$$k_{34} = 0$$

$$k_{24} = -\frac{4EI}{3} + \frac{EI}{3} = -EI$$

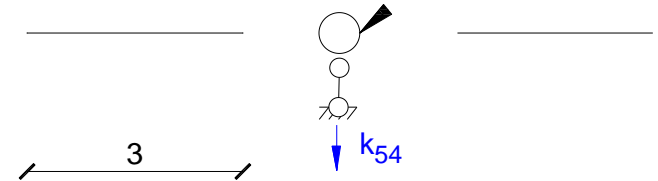

# Wykresy jednostkowe:

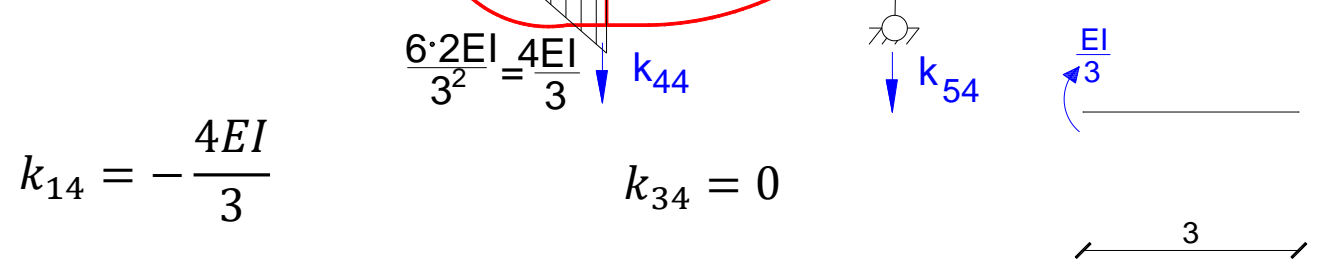
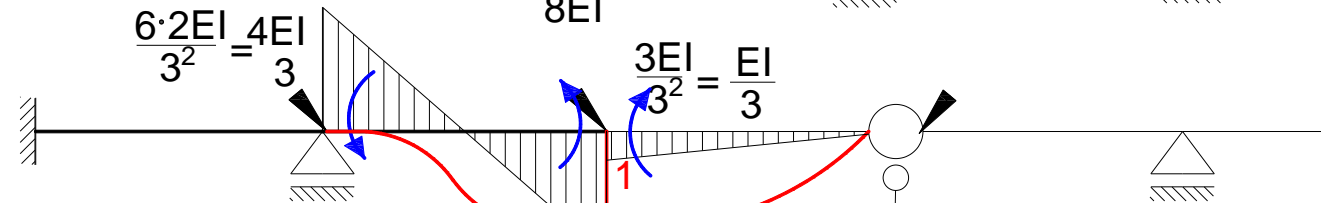
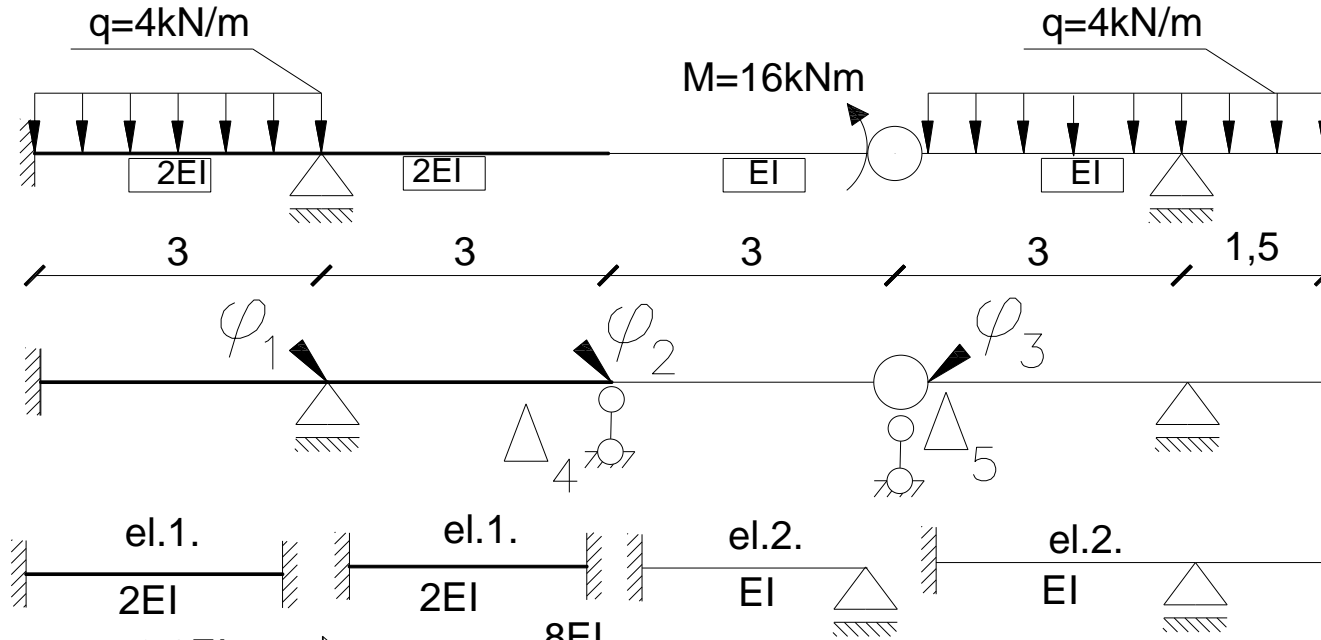

$$k_{14} = -\frac{4EI}{3}$$

$$k_{34} = 0$$

$$k_{24} = -\frac{4EI}{3} + \frac{EI}{3} = -EI$$

Stan  $\Delta_4=1$

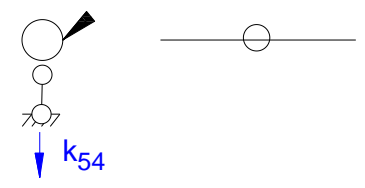

# Wykresy jednostkowe:

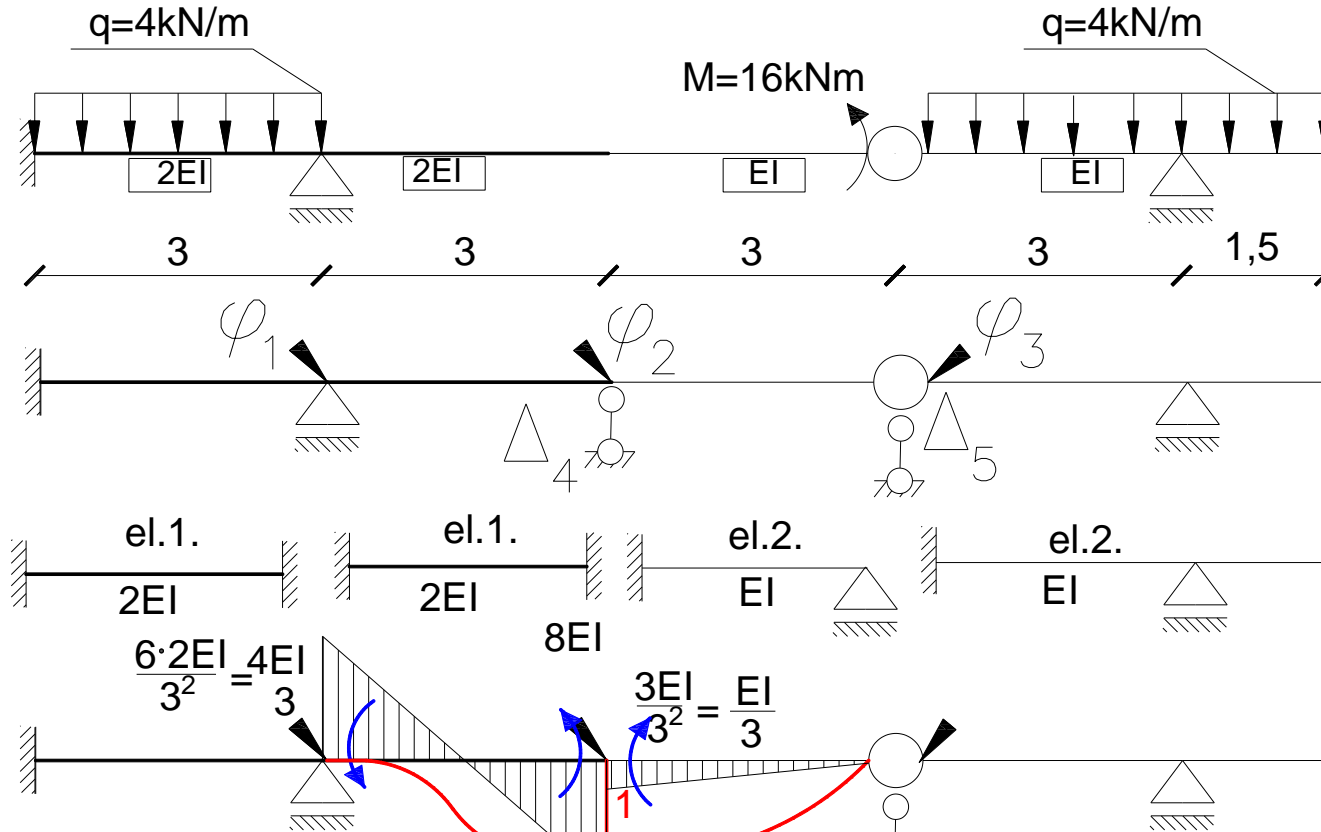

Stan  $\Delta_4=1$

$$k_{14} = -\frac{4EI}{3}$$

$$k_{34} = 0$$

$$k_{24} = -\frac{4EI}{3} + \frac{EI}{3} = -EI$$

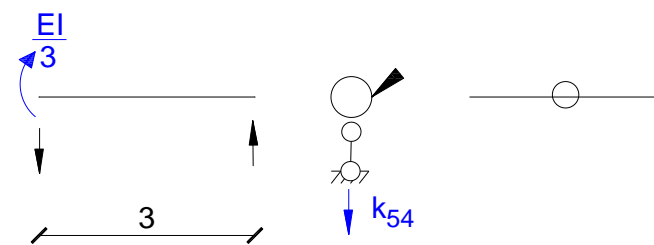

# Wykresy jednostkowe:

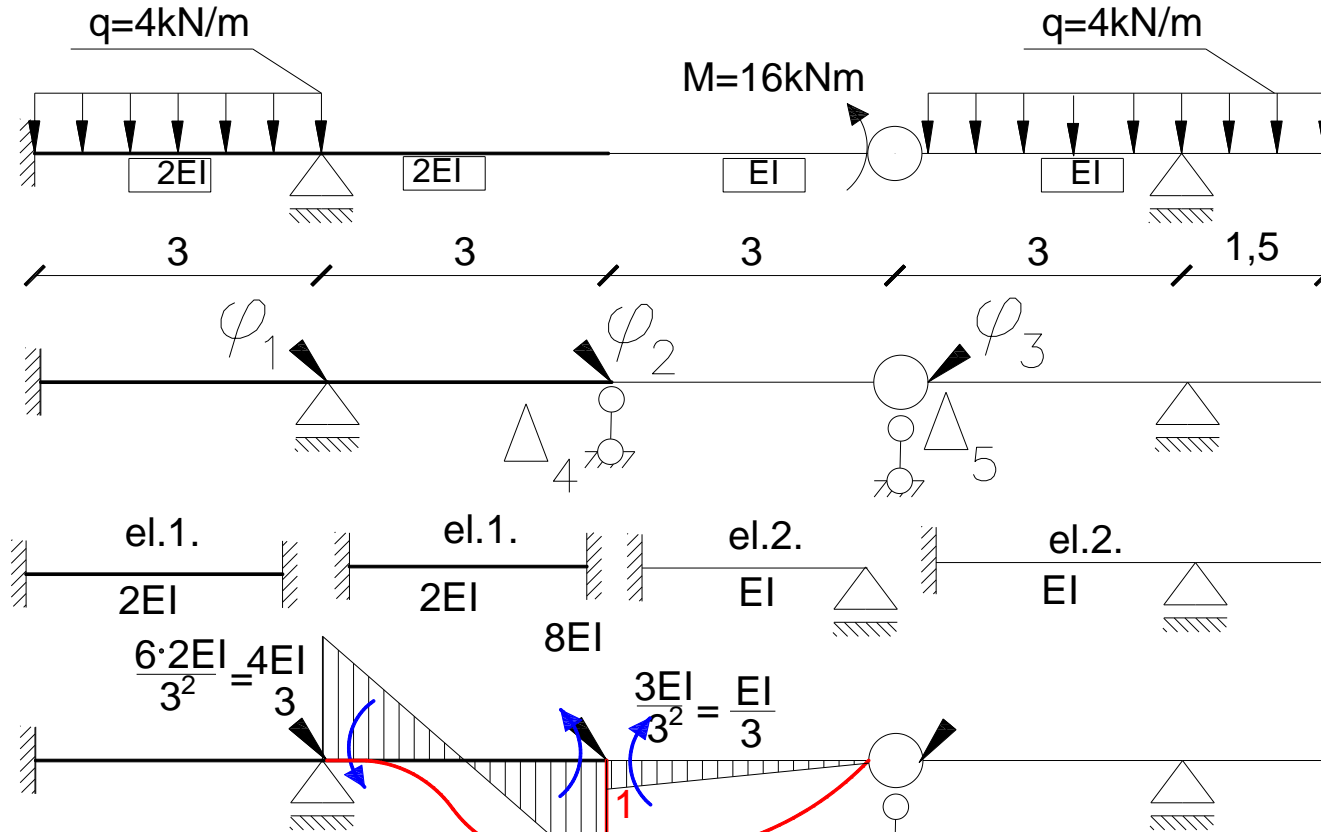

Stan  $\Delta_4=1$

$$k_{14} = -\frac{4EI}{3}$$

$$k_{34} = 0$$

$$k_{24} = -\frac{4EI}{3} + \frac{EI}{3} = -EI$$

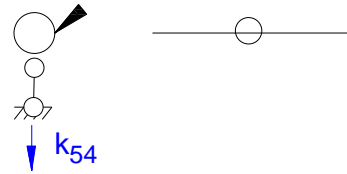
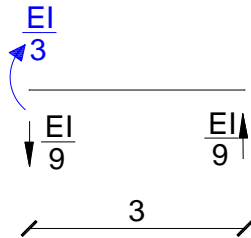

# Wykresy jednostkowe:

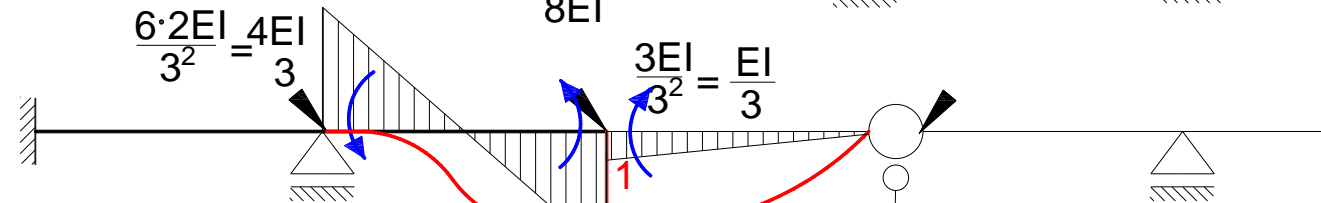
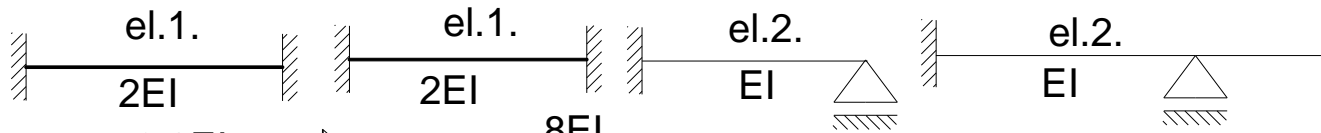
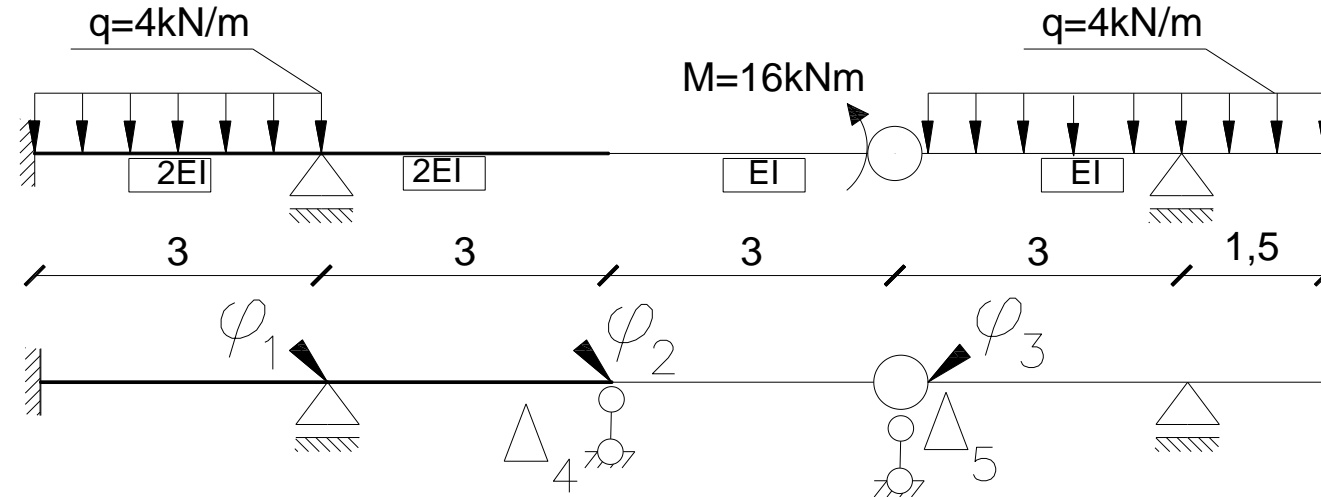

Stan  $\Delta_4=1$

$$k_{14} = -\frac{4EI}{3}$$

$$k_{34} = 0$$

$$k_{24} = -\frac{4EI}{3} + \frac{EI}{3} = -EI$$

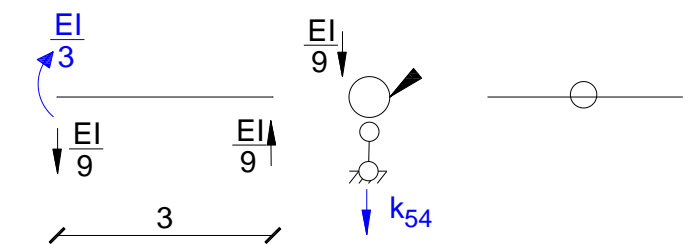

# Wykresy jednostkowe:

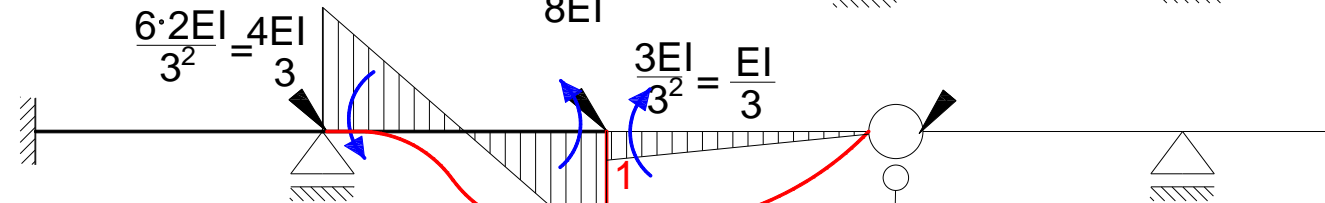
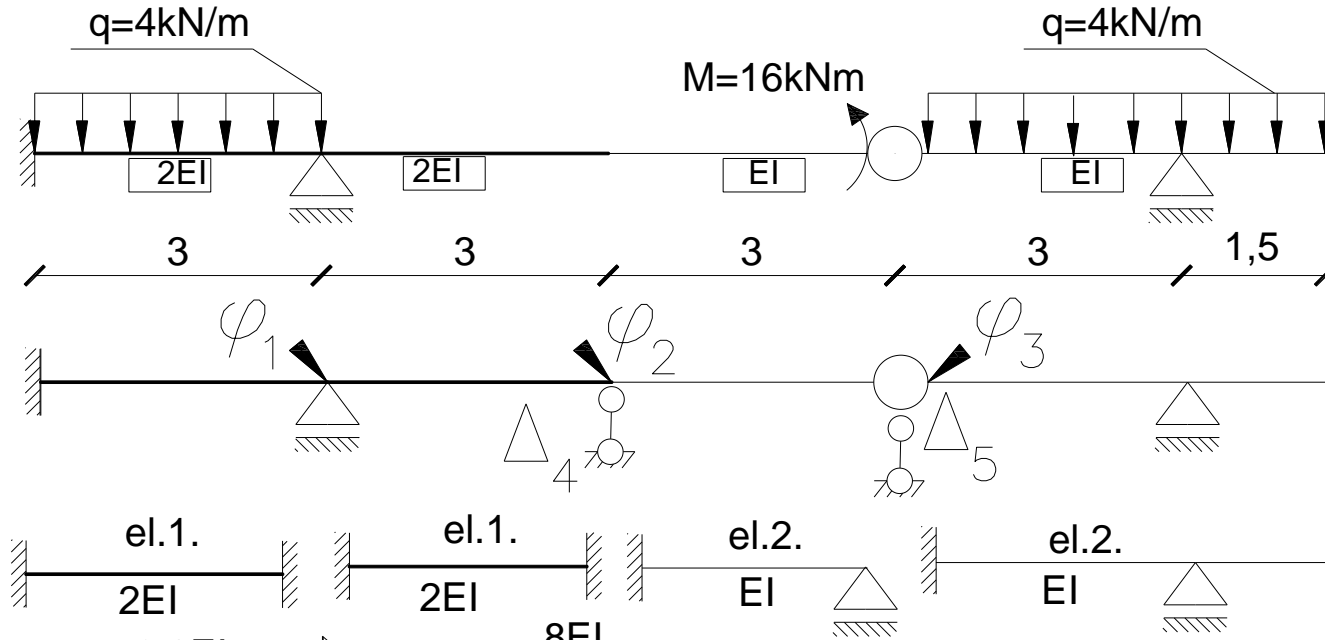

Stan  $\Delta_4=1$

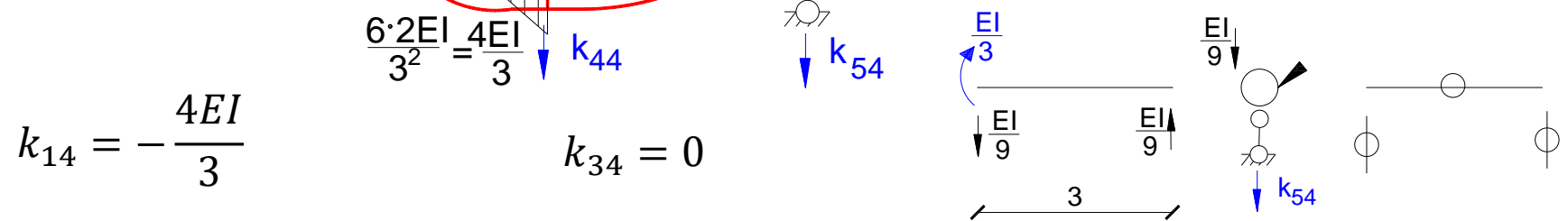

$$k_{14} = -\frac{4EI}{3}$$

$$k_{24} = -\frac{4EI}{3} + \frac{EI}{3} = -EI$$

$$k_{34} = 0$$



# Wykresy jednostkowe:

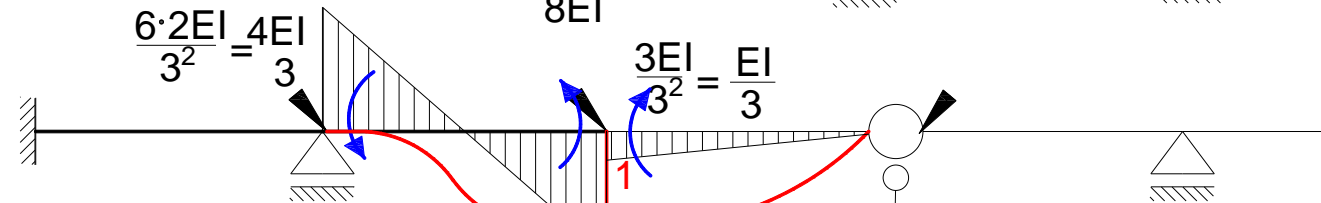
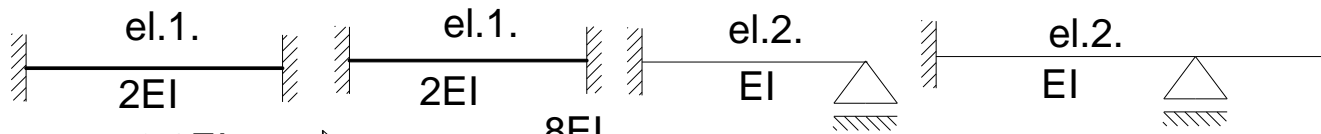
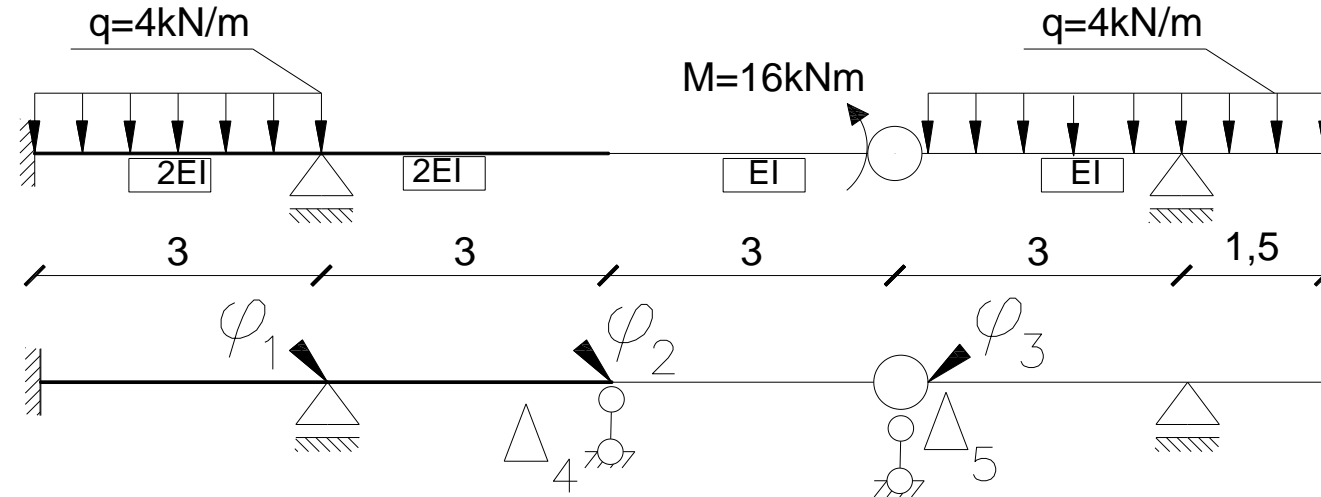

Stan  $\Delta_4=1$

$$k_{14} = -\frac{4EI}{3}$$

$$k_{34} = 0$$

$$k_{24} = -\frac{4EI}{3} + \frac{EI}{3} = -EI$$

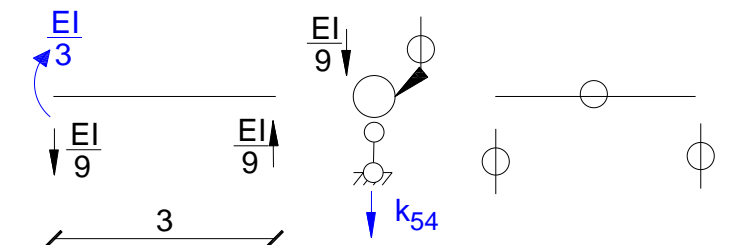

# Wykresy jednostkowe:

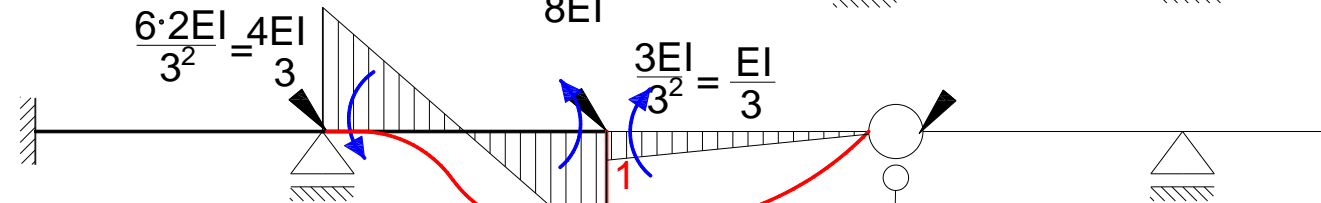
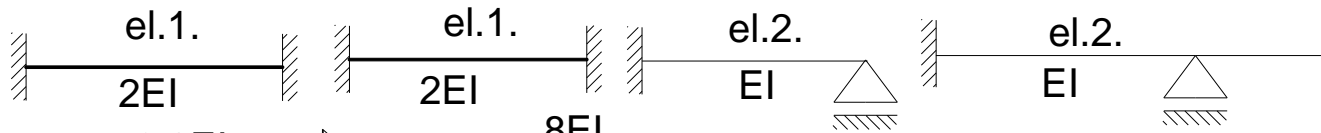
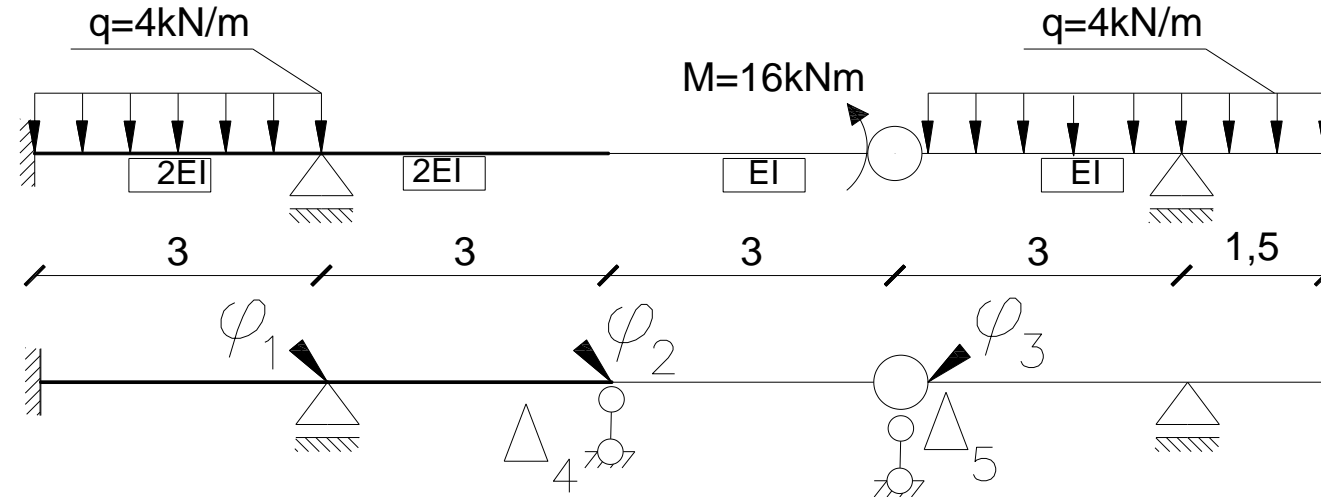

Stan  $\Delta_4=1$

$$k_{14} = -\frac{4EI}{3}$$

$$k_{34} = 0$$

$$k_{24} = -\frac{4EI}{3} + \frac{EI}{3} = -EI$$

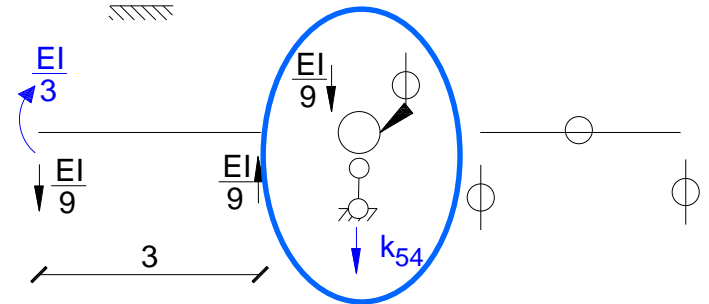

# Wykresy jednostkowe:

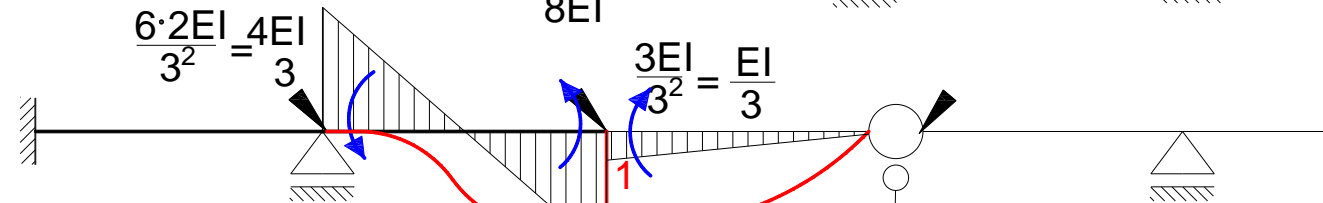
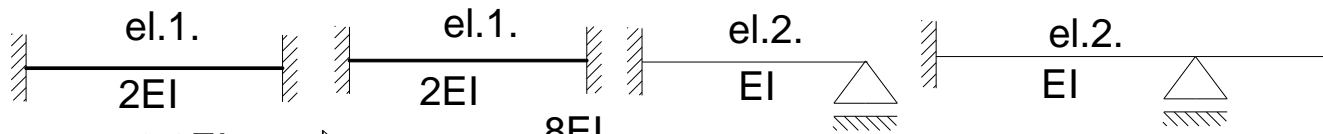
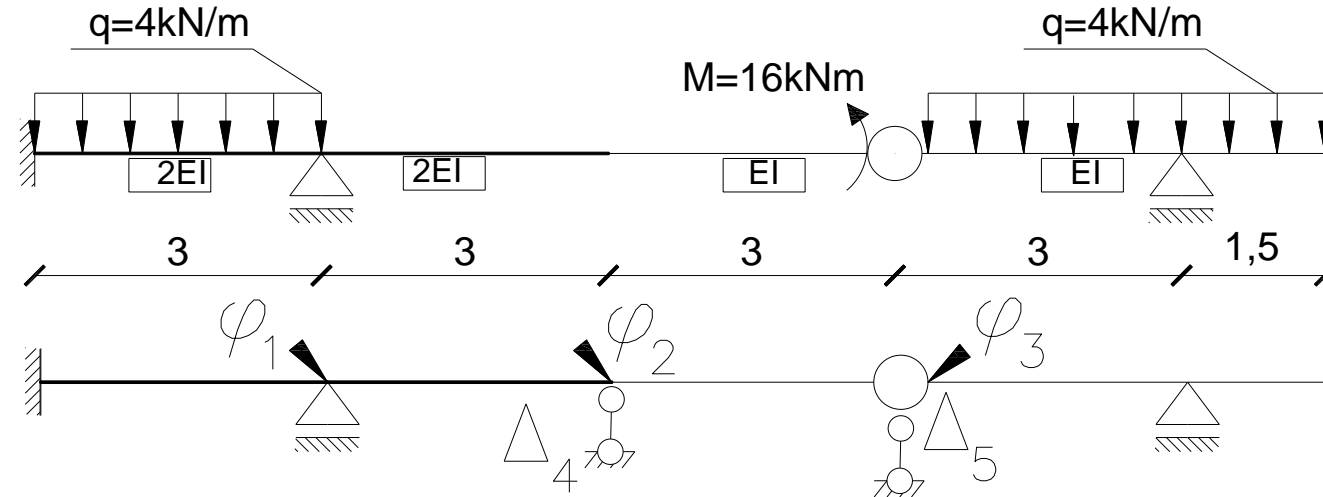

Stan  $\Delta_4=1$

$$k_{14} = -\frac{4EI}{3}$$

$$k_{34} = 0$$

$$k_{24} = -\frac{4EI}{3} + \frac{EI}{3} = -EI$$

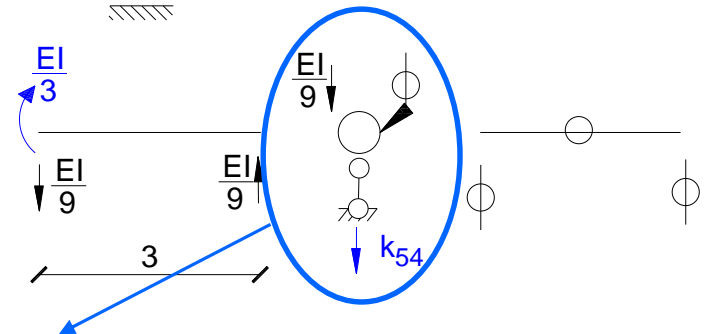

# Wykresy jednostkowe:

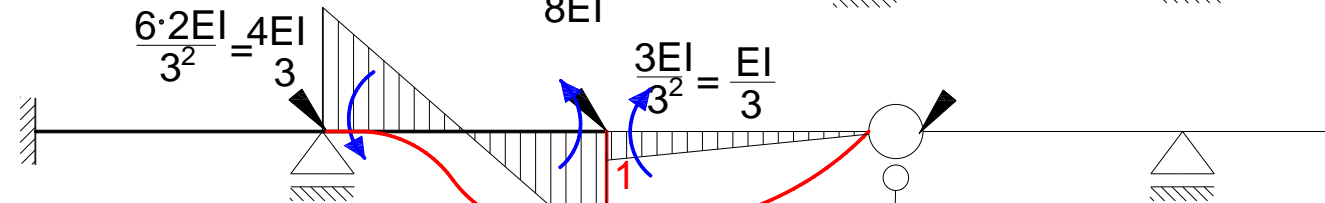
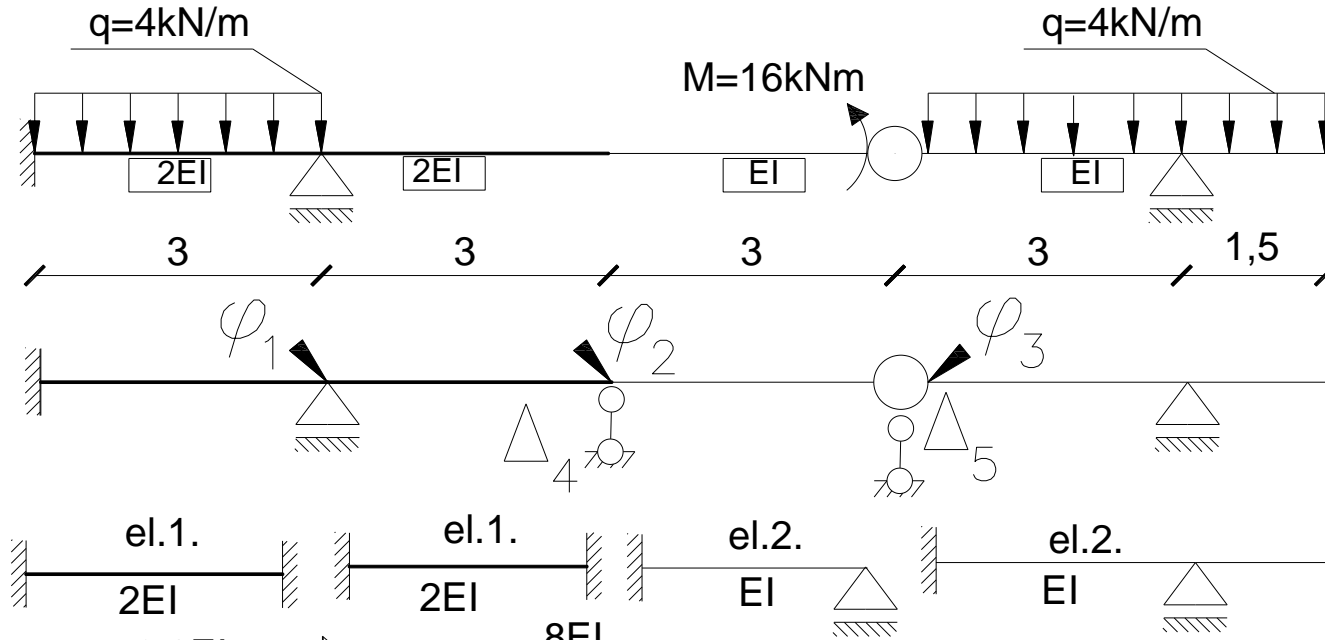

Stan  $\Delta_4=1$

$$k_{14} = -\frac{4EI}{3}$$

$$k_{34} = 0$$

$$k_{24} = -\frac{4EI}{3} + \frac{EI}{3} = -EI$$

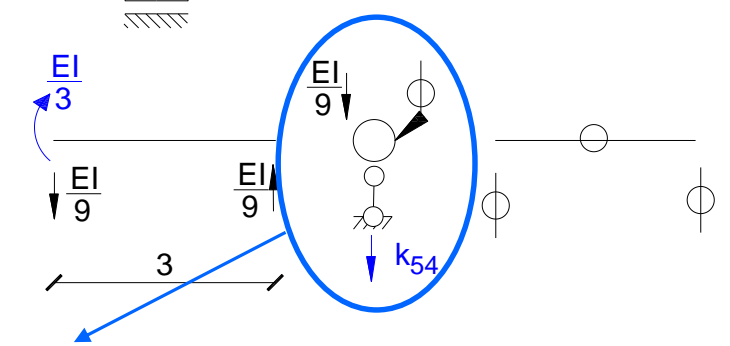

$$\sum R_y = -\frac{EI}{9} - k_{54} = 0 \rightarrow k_{54} = -\frac{EI}{9}$$

dr inż. Hanna Weber

# Wykresy jednostkowe:

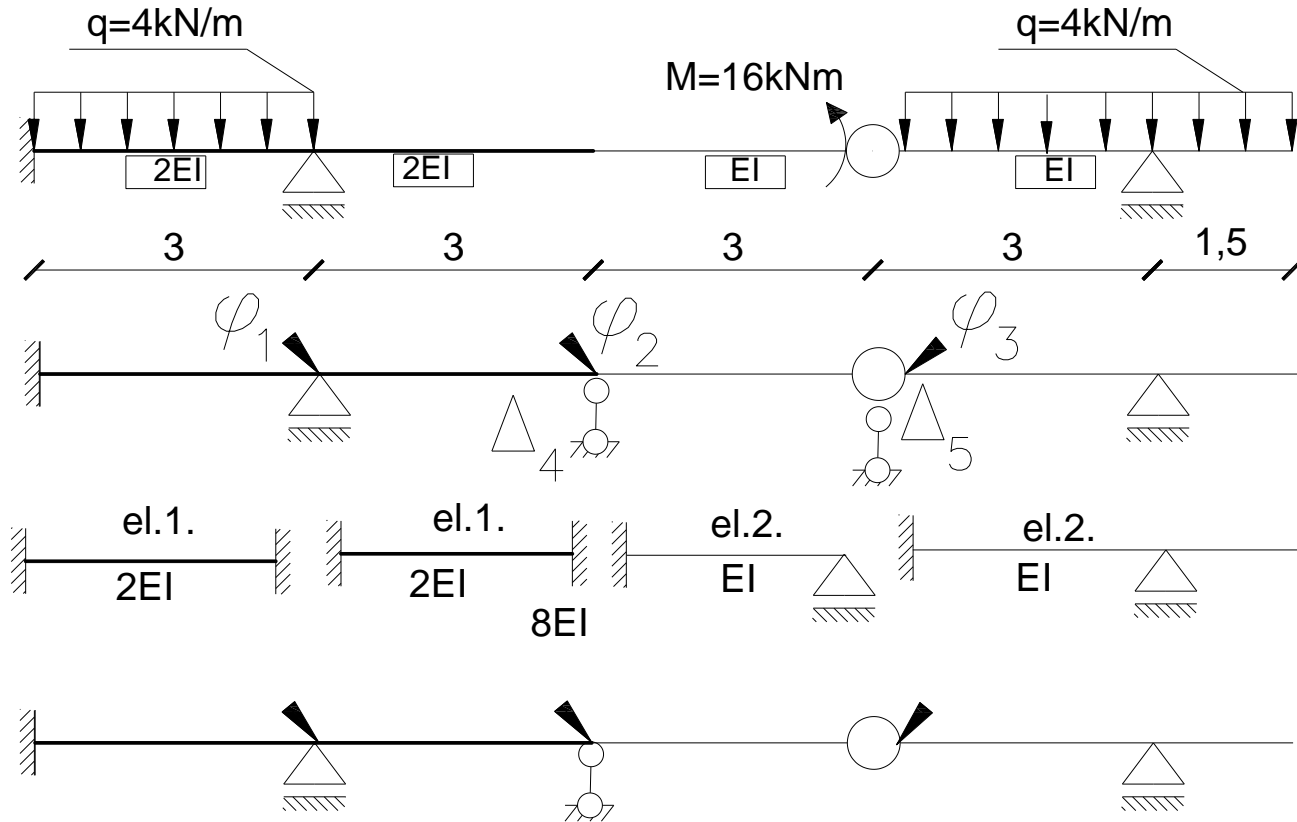

Stan  $\Delta_5=1$

# Wykresy jednostkowe:

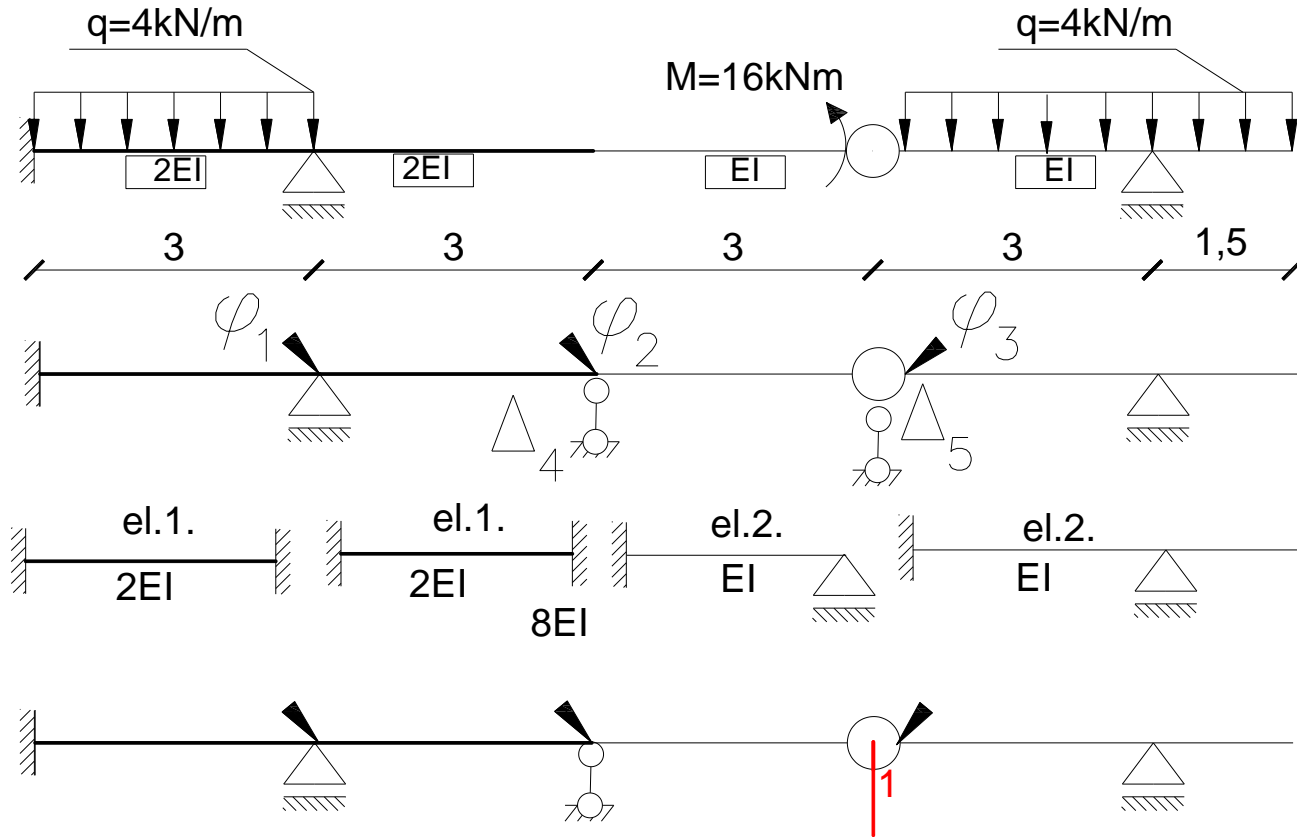

Stan  $\Delta_5=1$

# Wykresy jednostkowe:

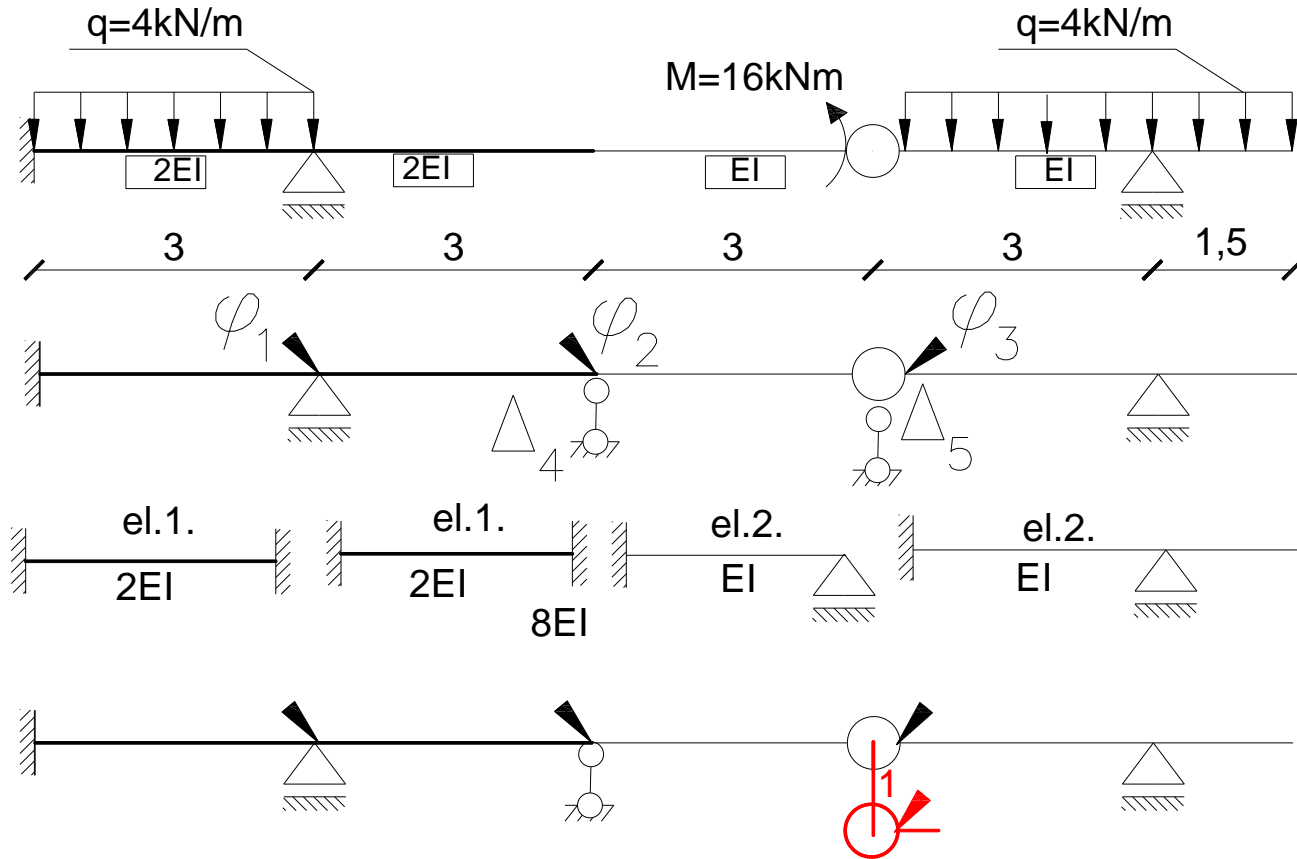

Stan  $\Delta_5=1$

# Wykresy jednostkowe:

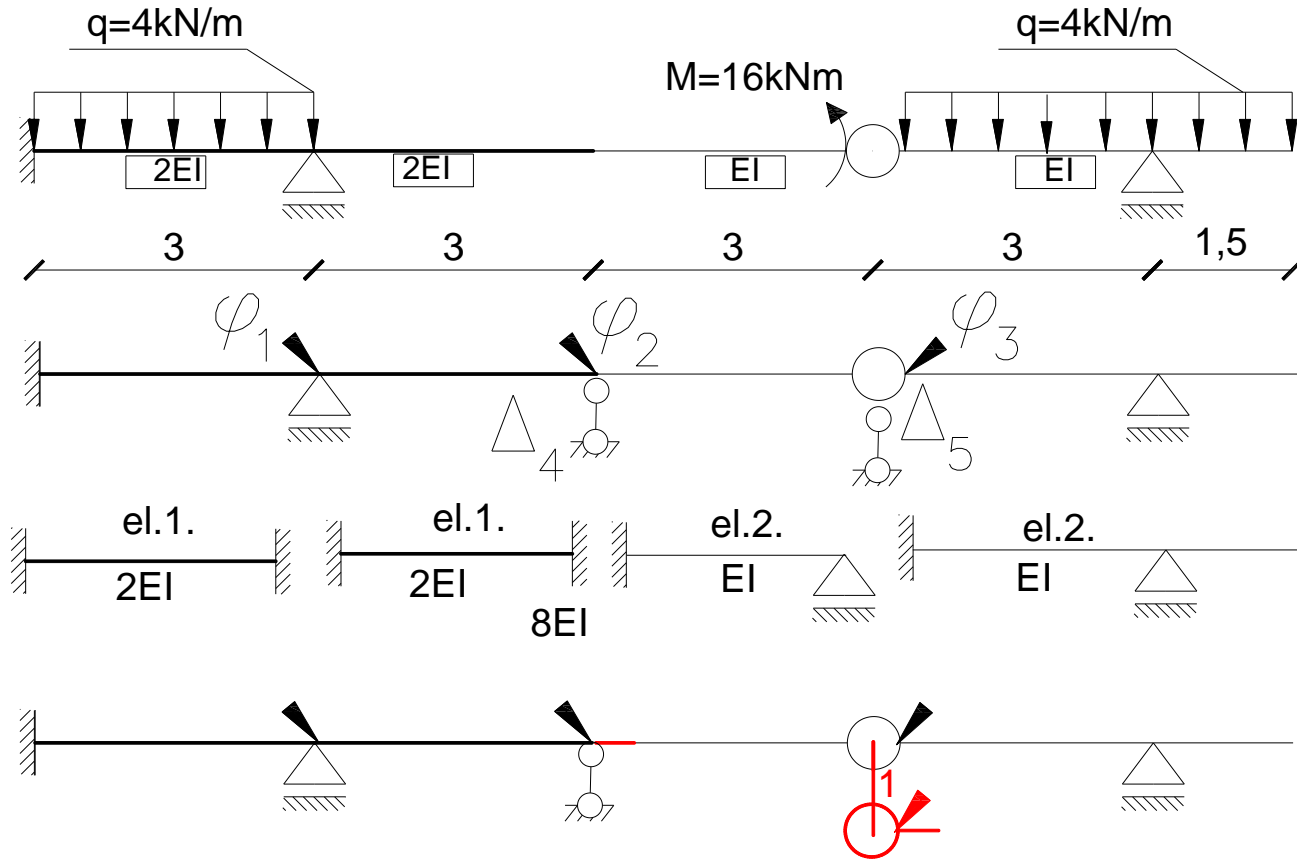

Stan  $\Delta_5=1$



# Wykresy jednostkowe:

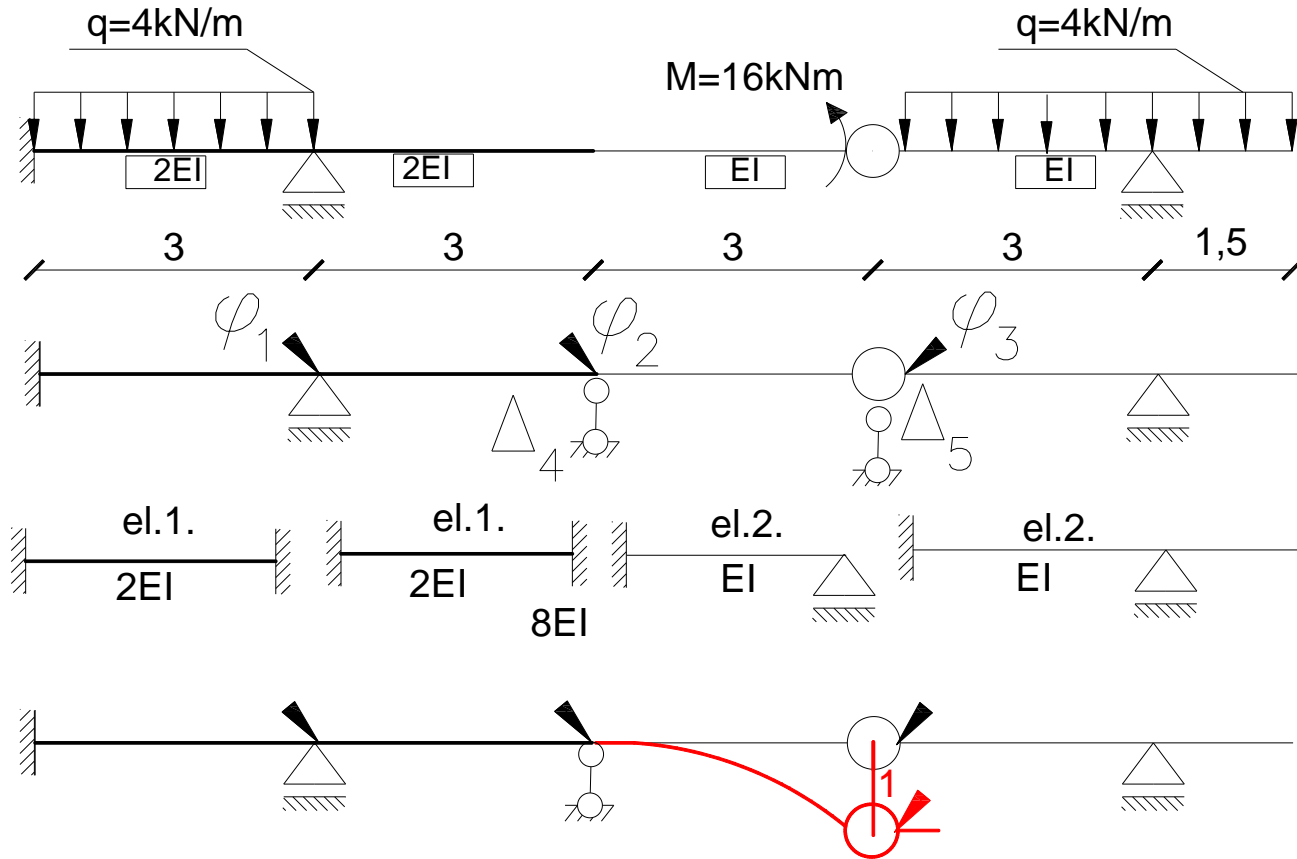

Stan  $\Delta_5=1$

# Wykresy jednostkowe:

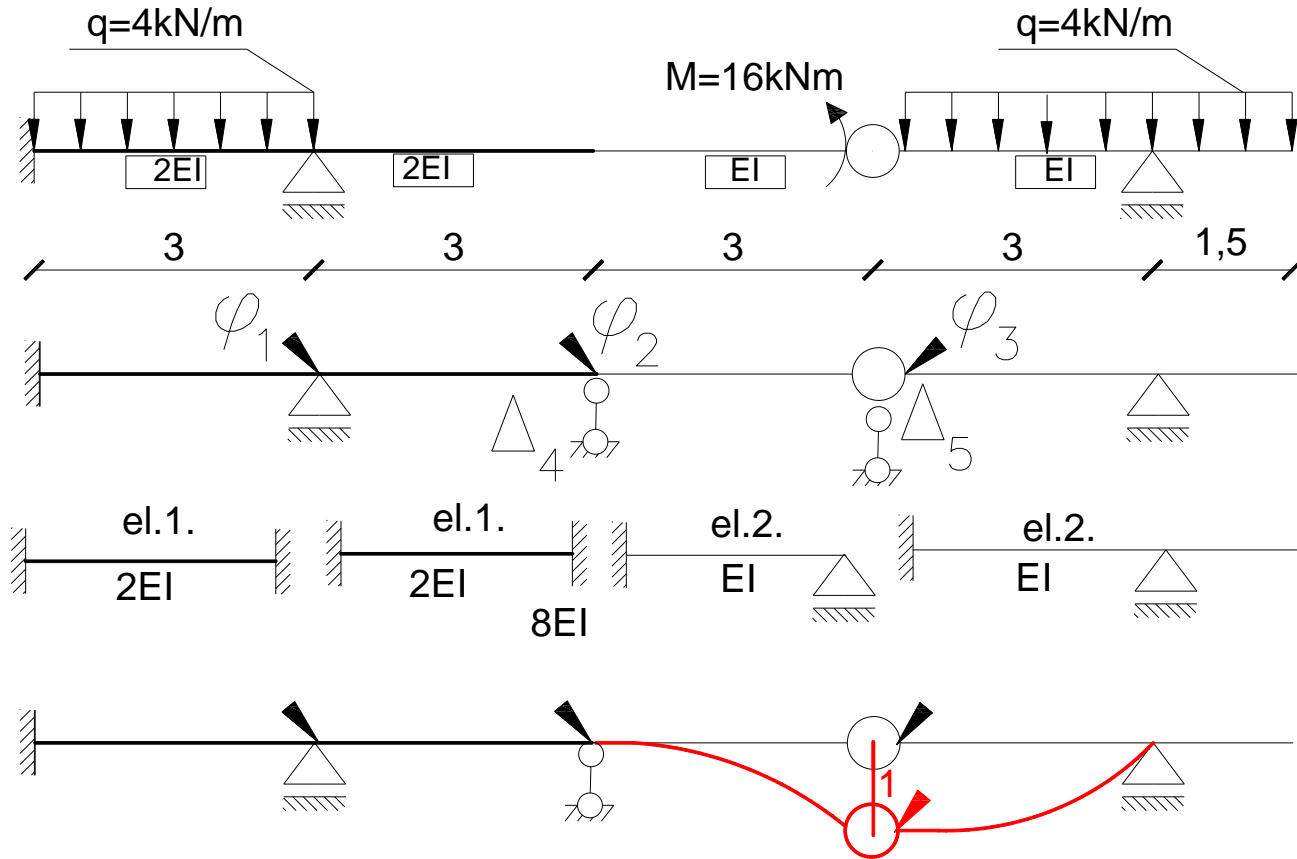

Stan  $\Delta_5=1$

# Wykresy jednostkowe:

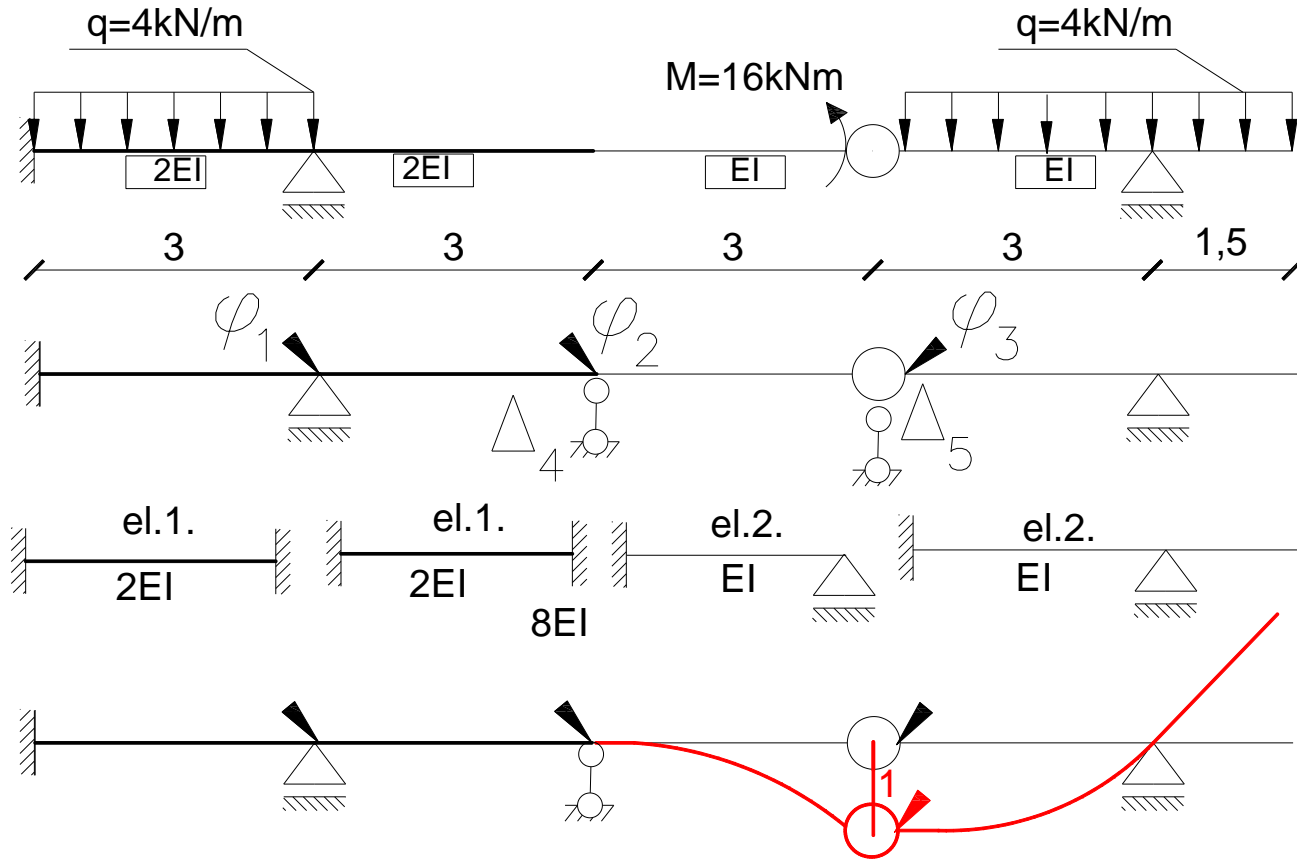

Stan  $\Delta_5=1$

# Wykresy jednostkowe:

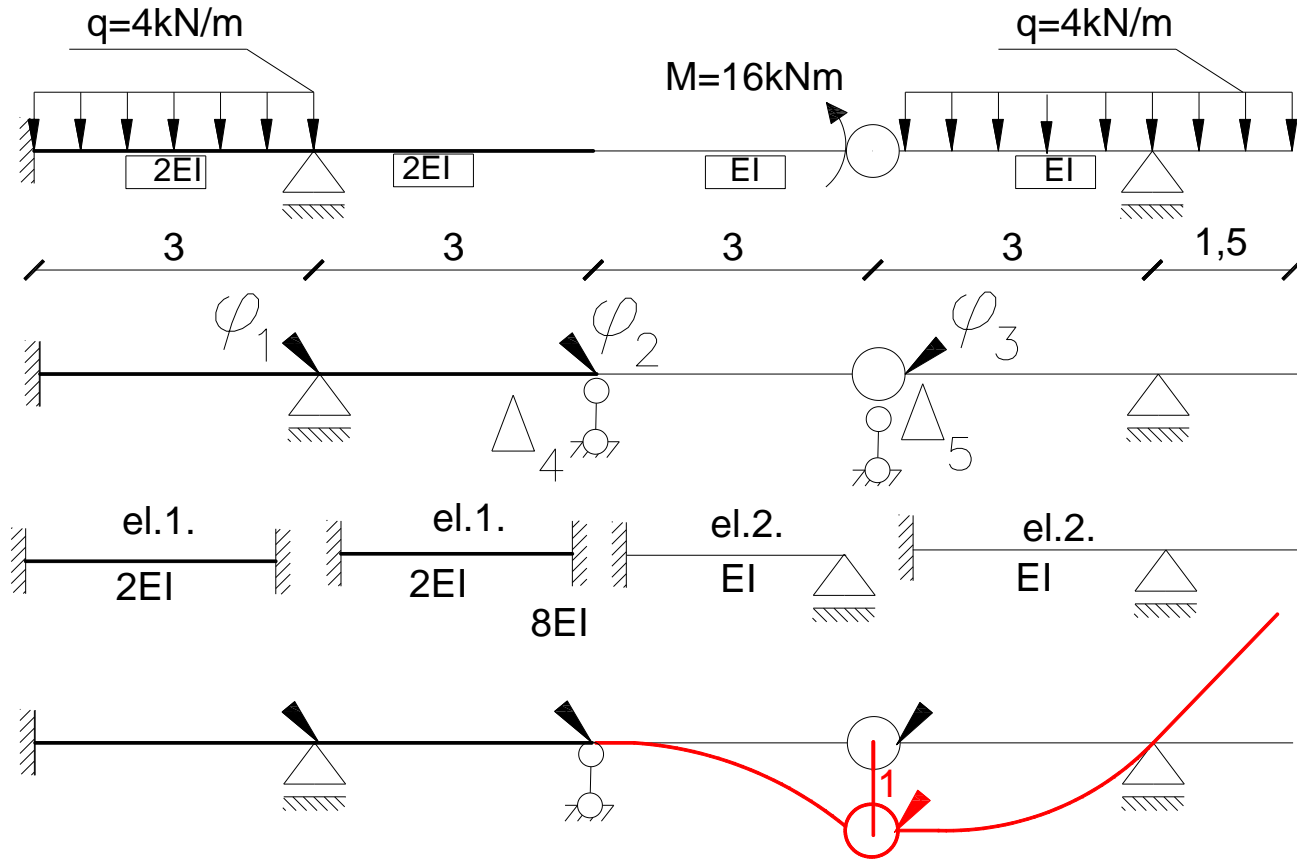

Stan  $\Delta_5=1$

23		$3 \frac{EJ}{l^2}$	0
----	--	--------------------	---



# Wykresy jednostkowe:

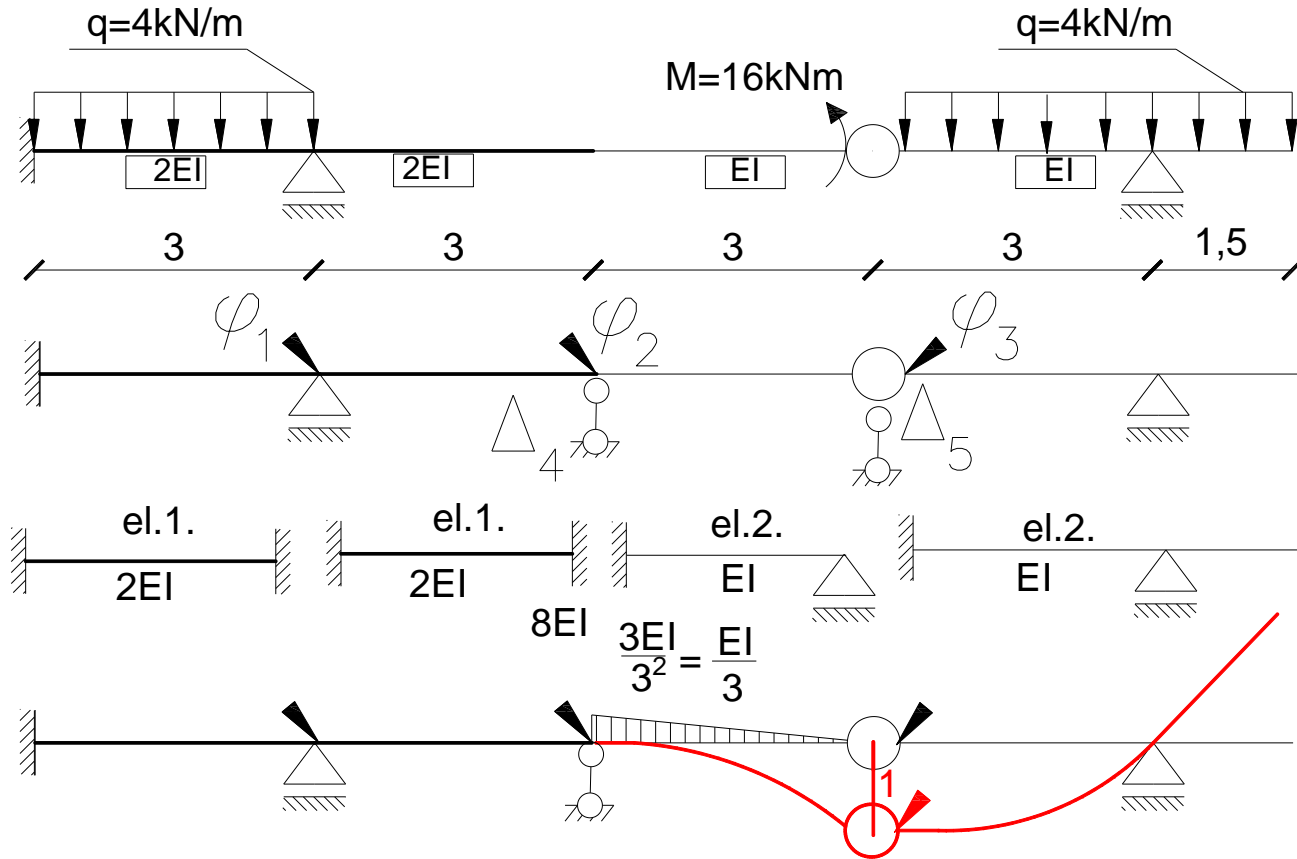

Stan  $\Delta_5=1$

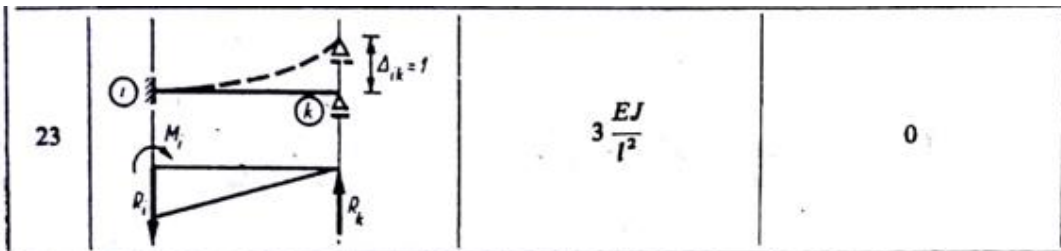

# Wykresy jednostkowe:

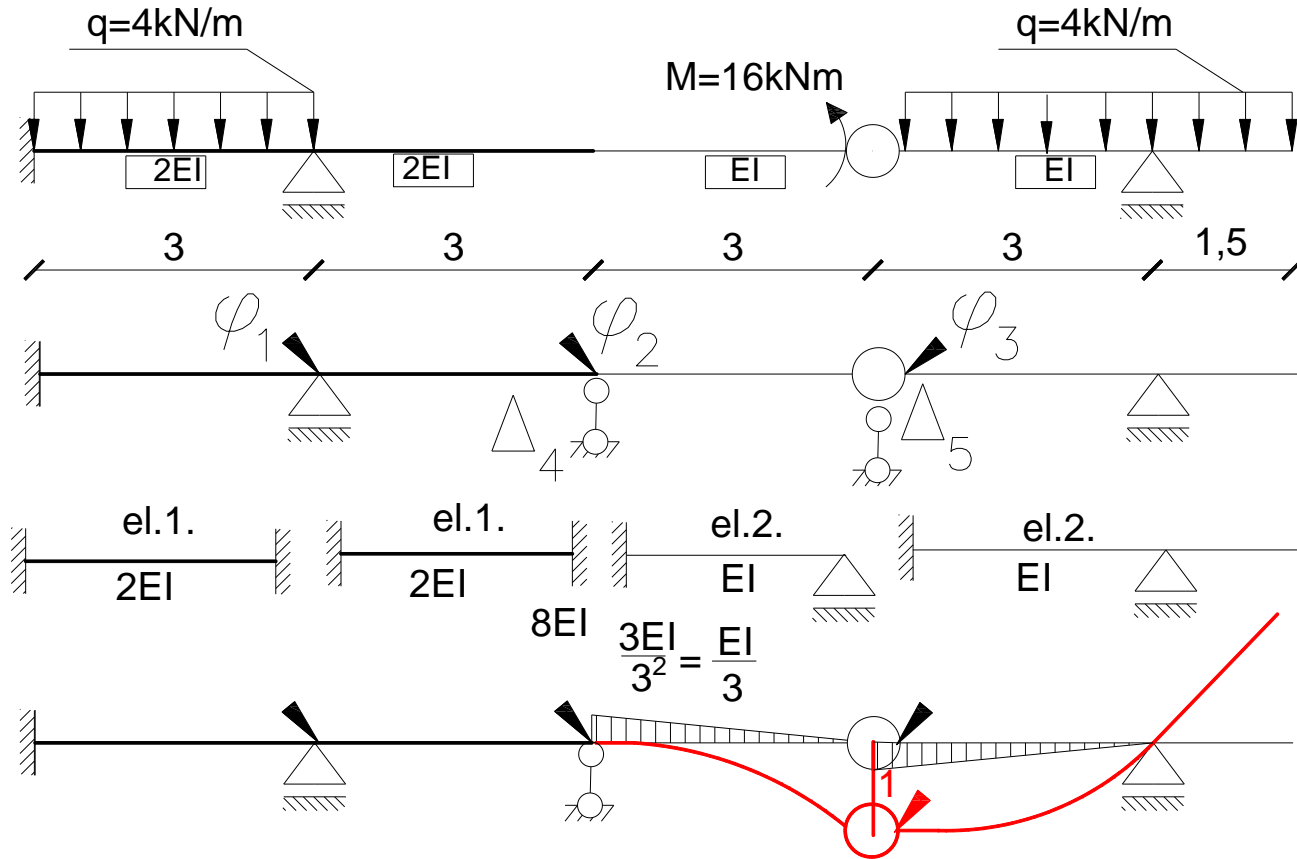

Stan  $\Delta_5=1$

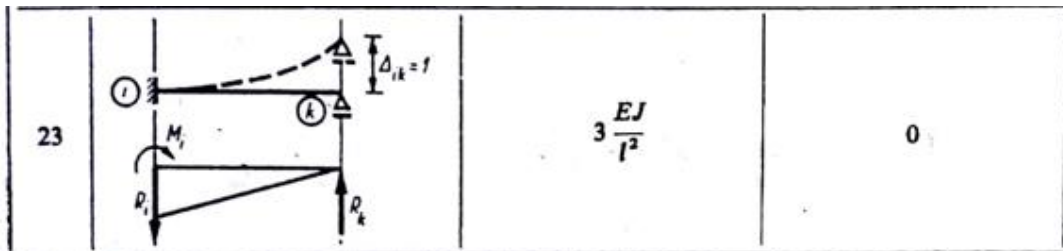

# Wykresy jednostkowe:

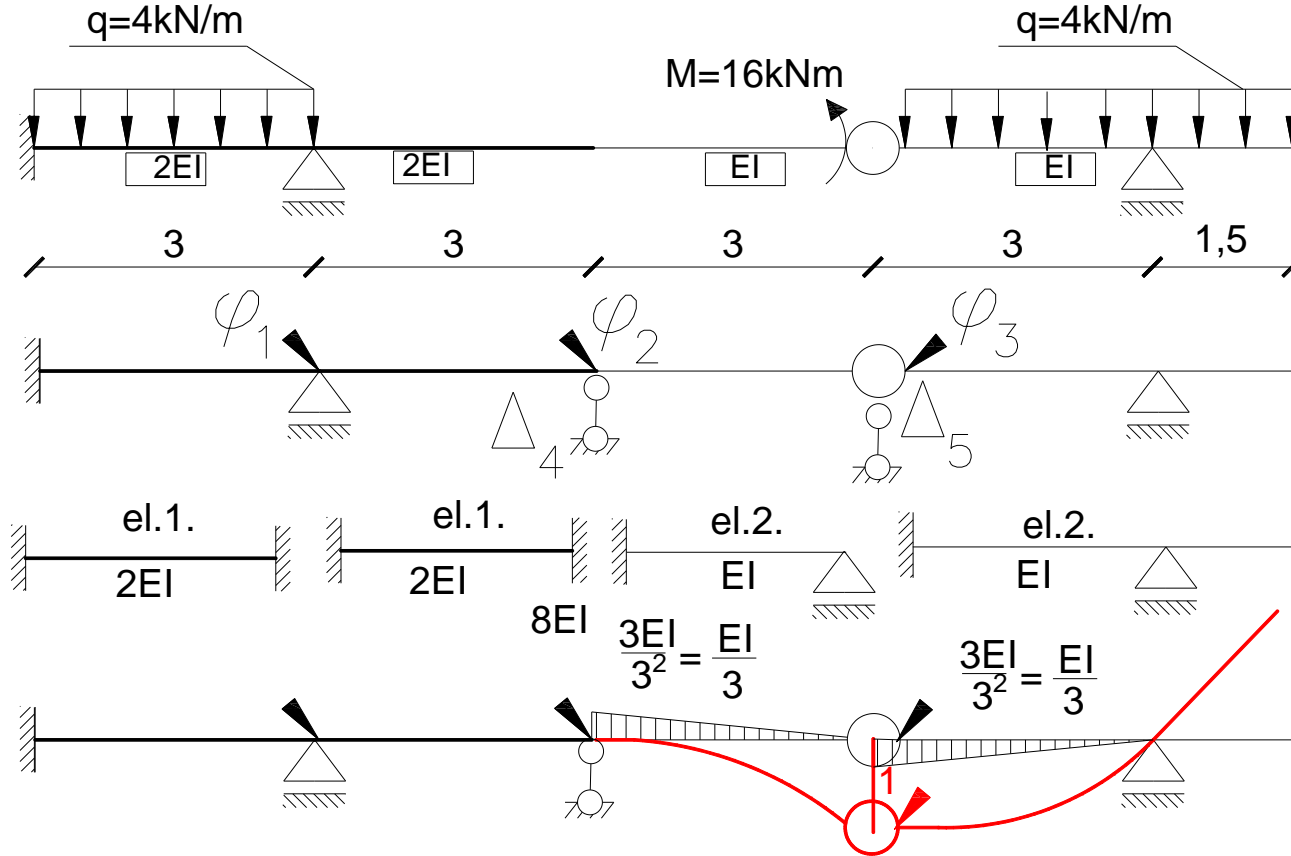

Stan  $\Delta_5=1$

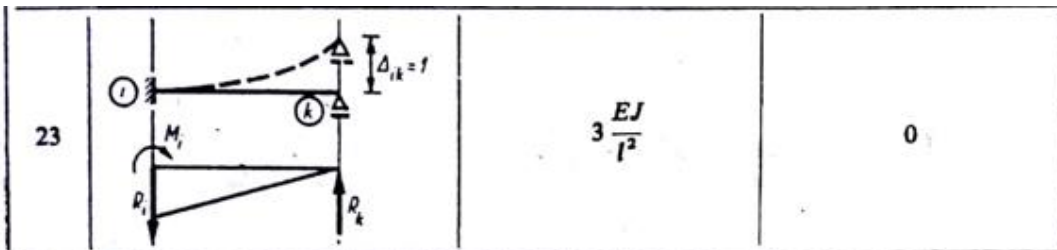



# Wykresy jednostkowe:

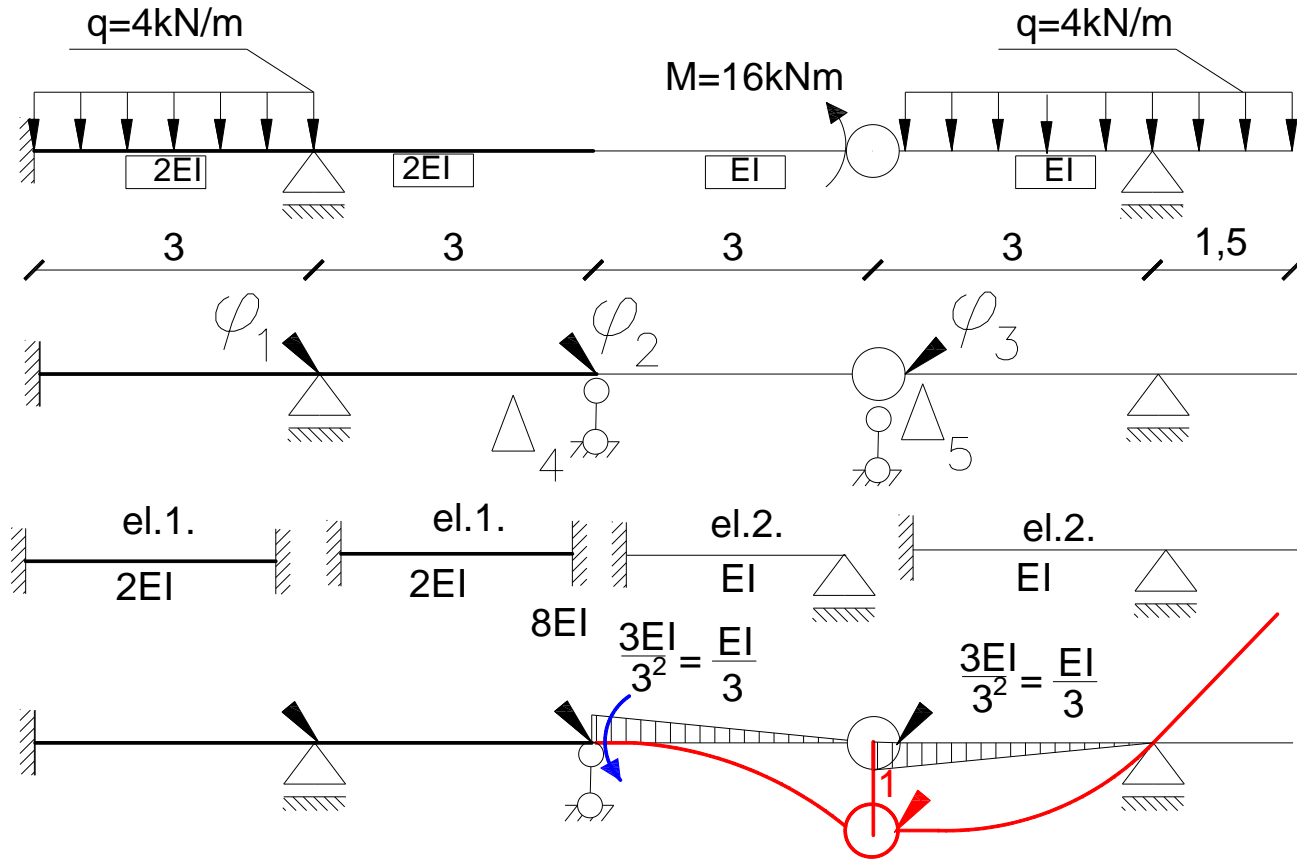

Stan  $\Delta_5=1$

# Wykresy jednostkowe:

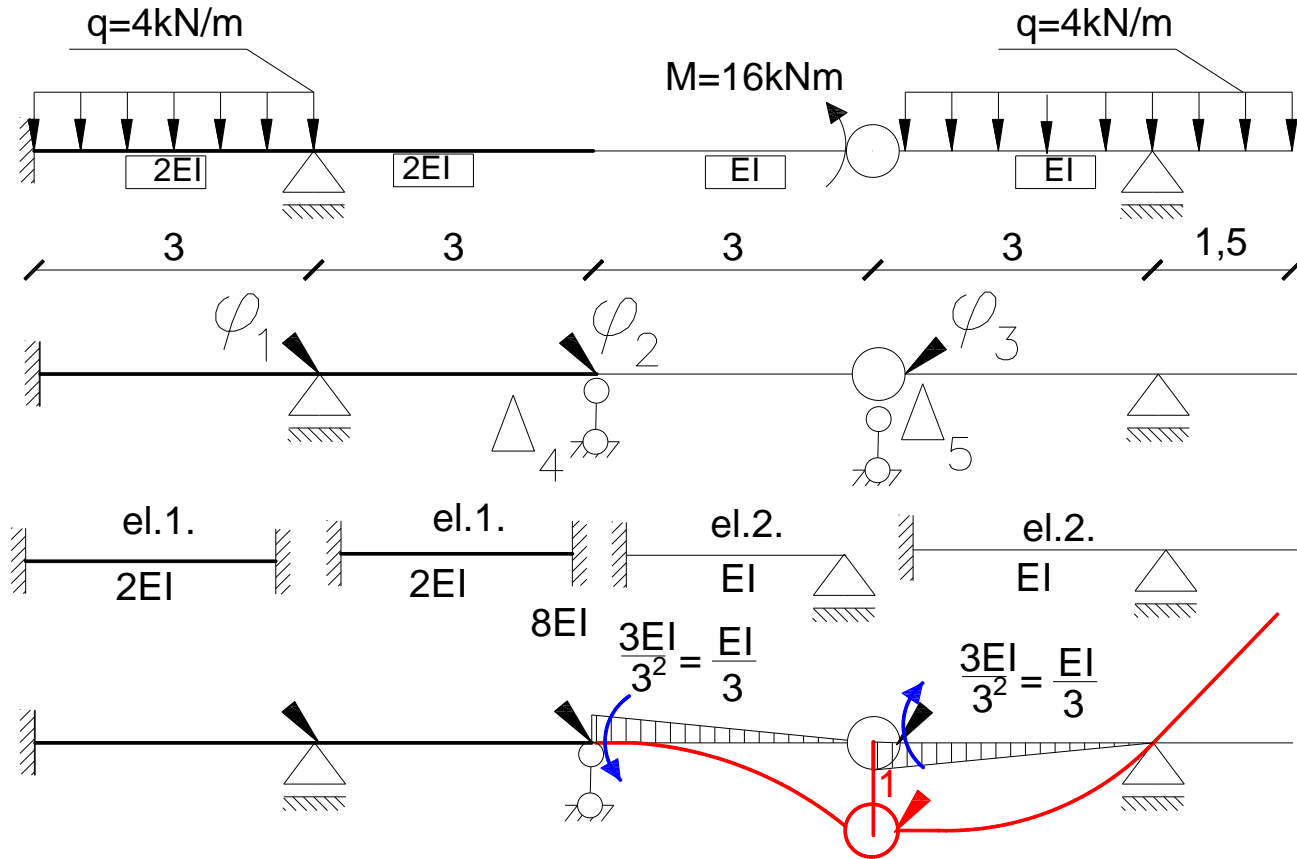

Stan  $\Delta_5=1$

# Wykresy jednostkowe:

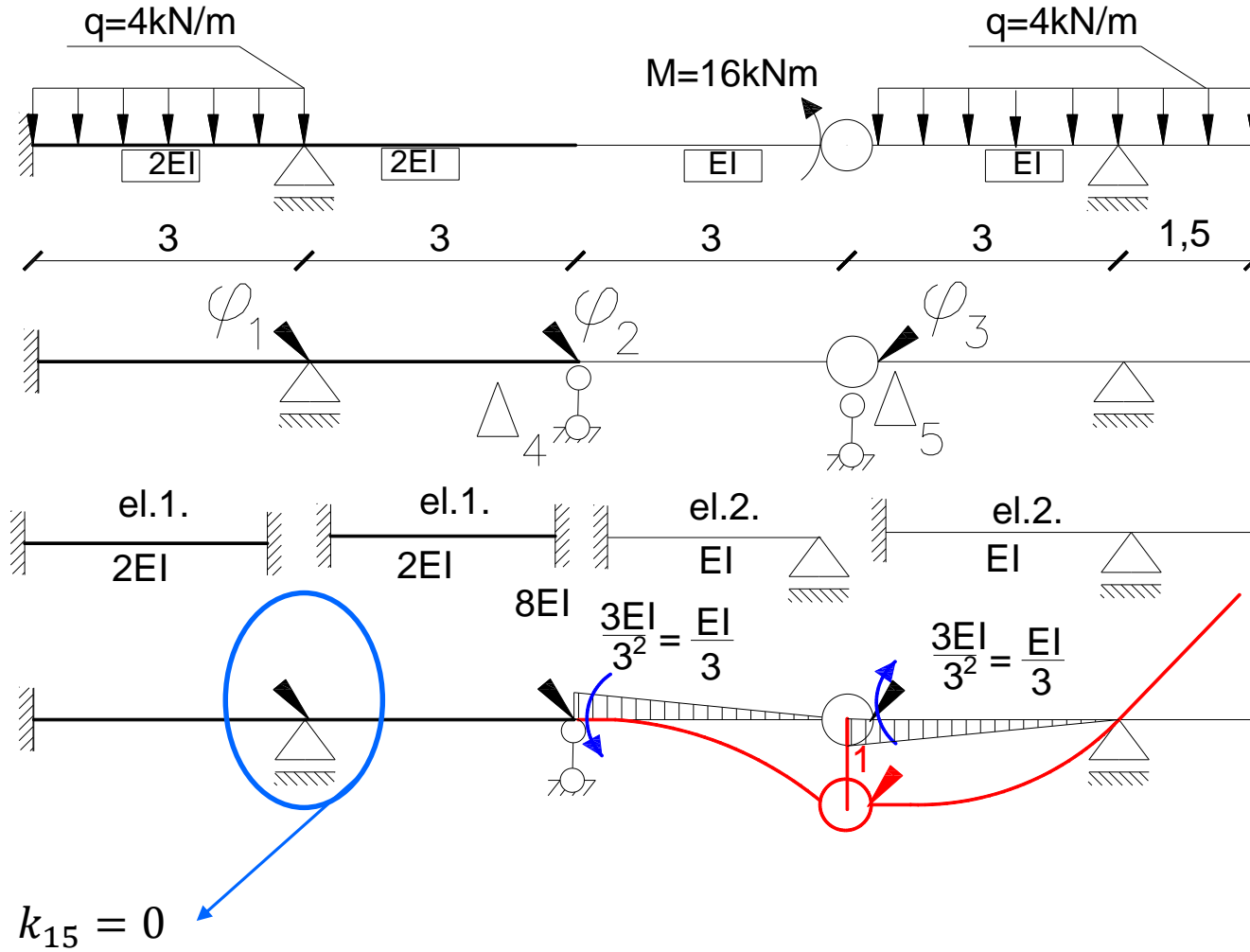

Stan  $\Delta_5=1$

# Wykresy jednostkowe:

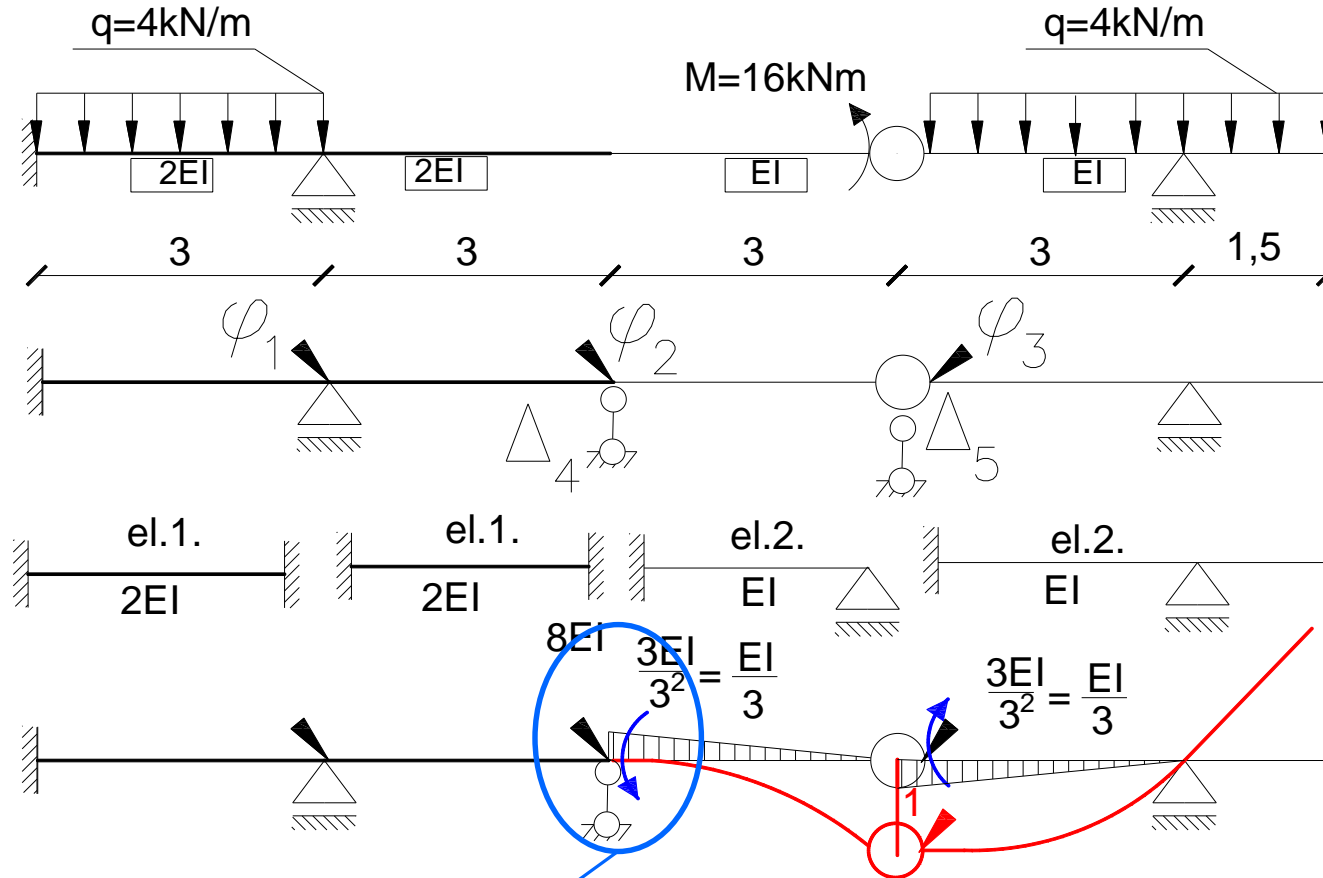

Stan  $\Delta_5=1$

$$k_{15} = 0$$

$$k_{25} = -\frac{EI}{3}$$

# Wykresy jednostkowe:

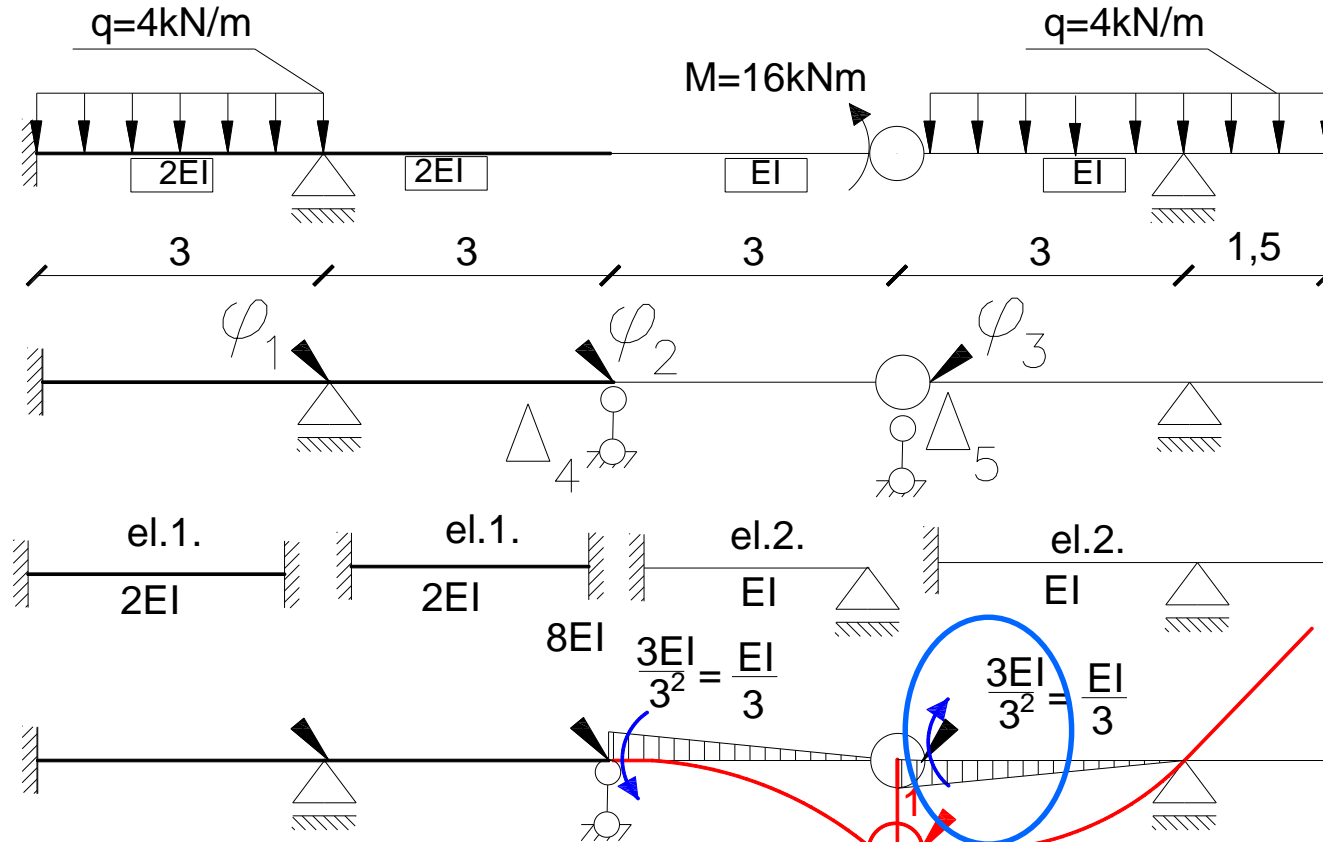

Stan  $\Delta_5=1$

$$k_{15} = 0$$

$$k_{25} = -\frac{EI}{3}$$

$$k_{35} = \frac{EI}{3}$$

# Wykresy jednostkowe:

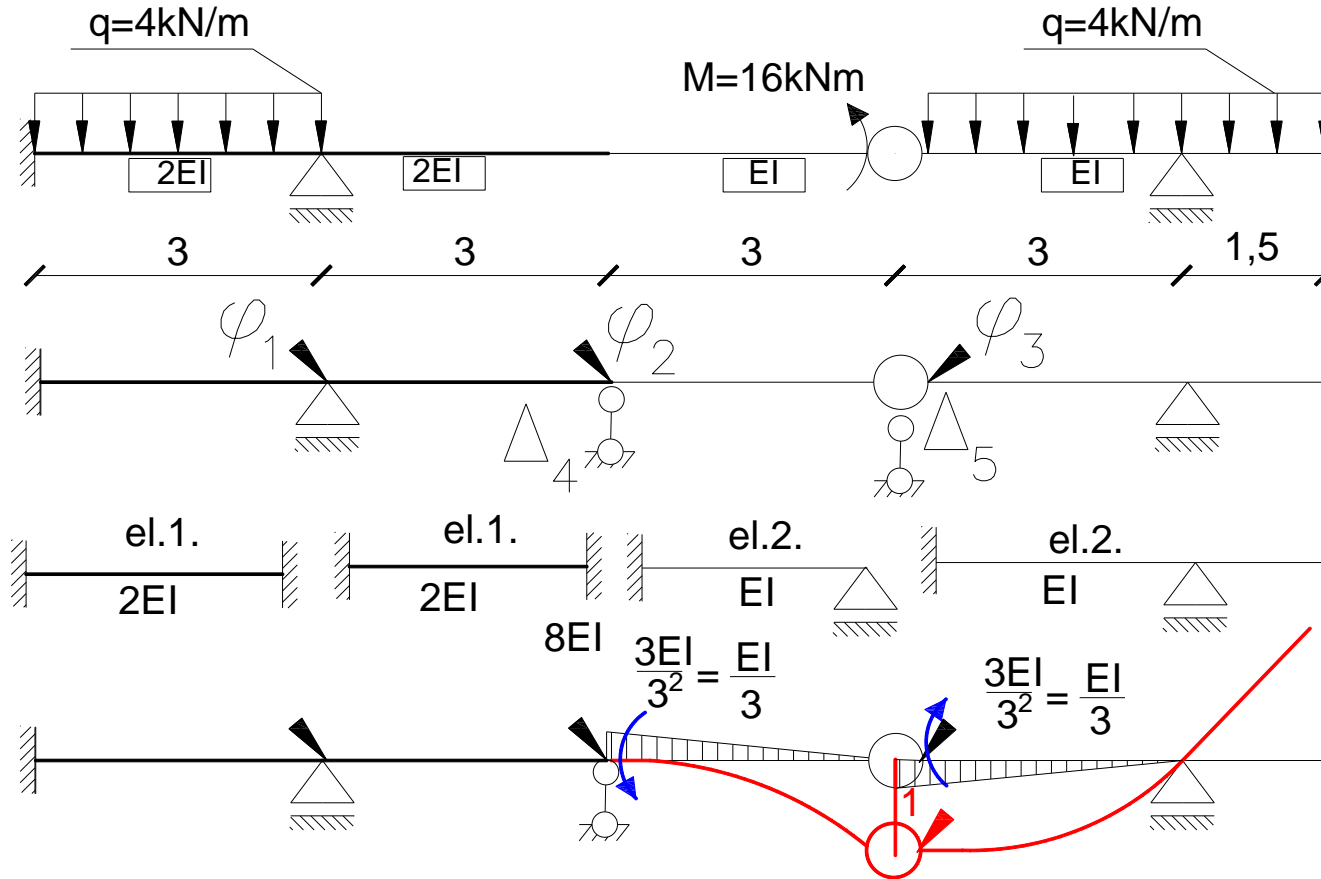

Stan  $\Delta_5=1$

$$k_{15} = 0$$

$$k_{35} = \frac{EI}{3}$$

$$k_{25} = -\frac{EI}{3}$$

# Wykresy jednostkowe:

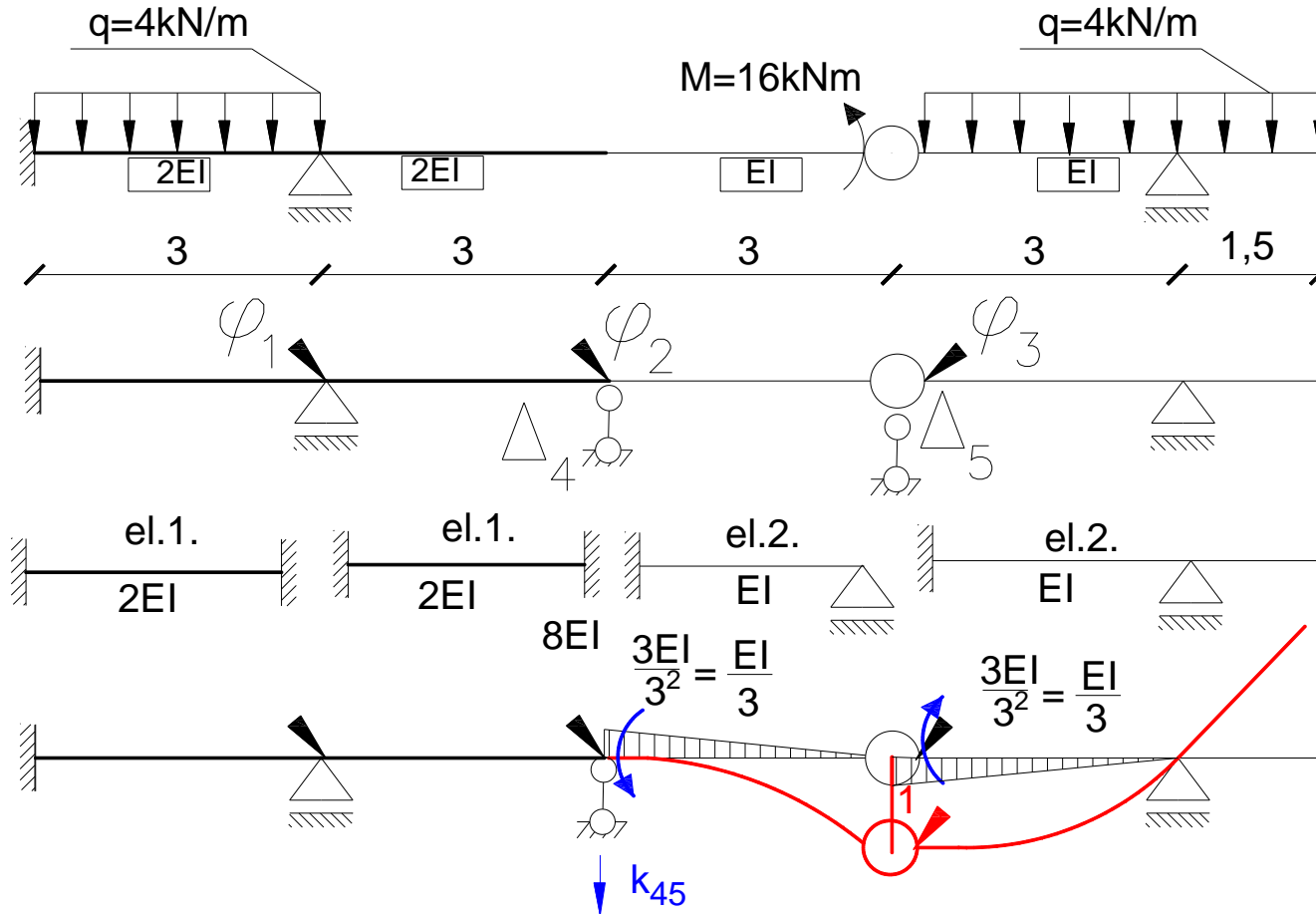

Stan  $\Delta_5=1$

$$k_{15} = 0$$

$$k_{35} = \frac{EI}{3}$$

$$k_{25} = -\frac{EI}{3}$$

# Wykresy jednostkowe:

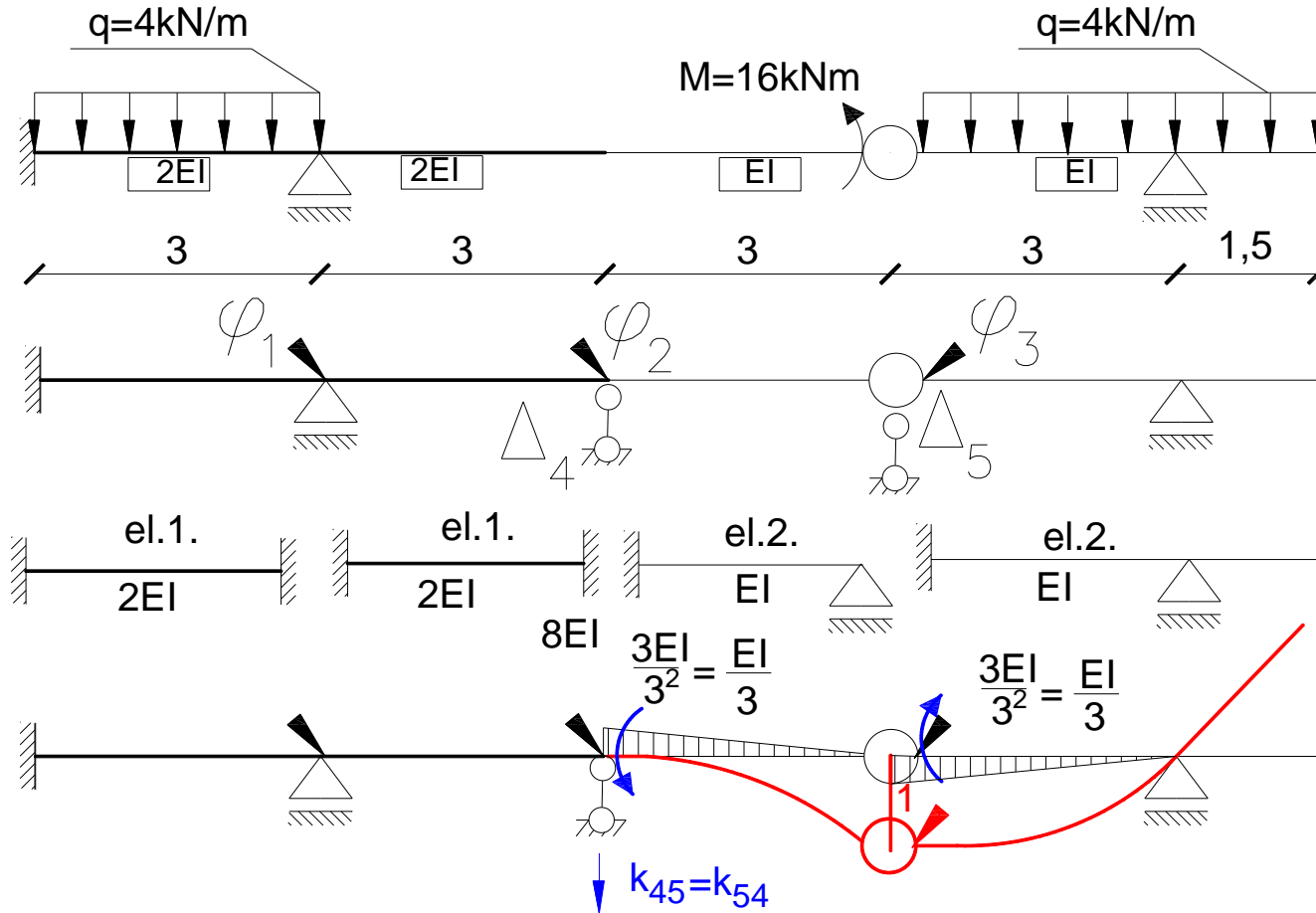

Stan  $\Delta_5=1$

$$k_{15} = 0$$

$$k_{35} = \frac{EI}{3}$$

$$k_{25} = -\frac{EI}{3}$$



# Wykresy jednostkowe:

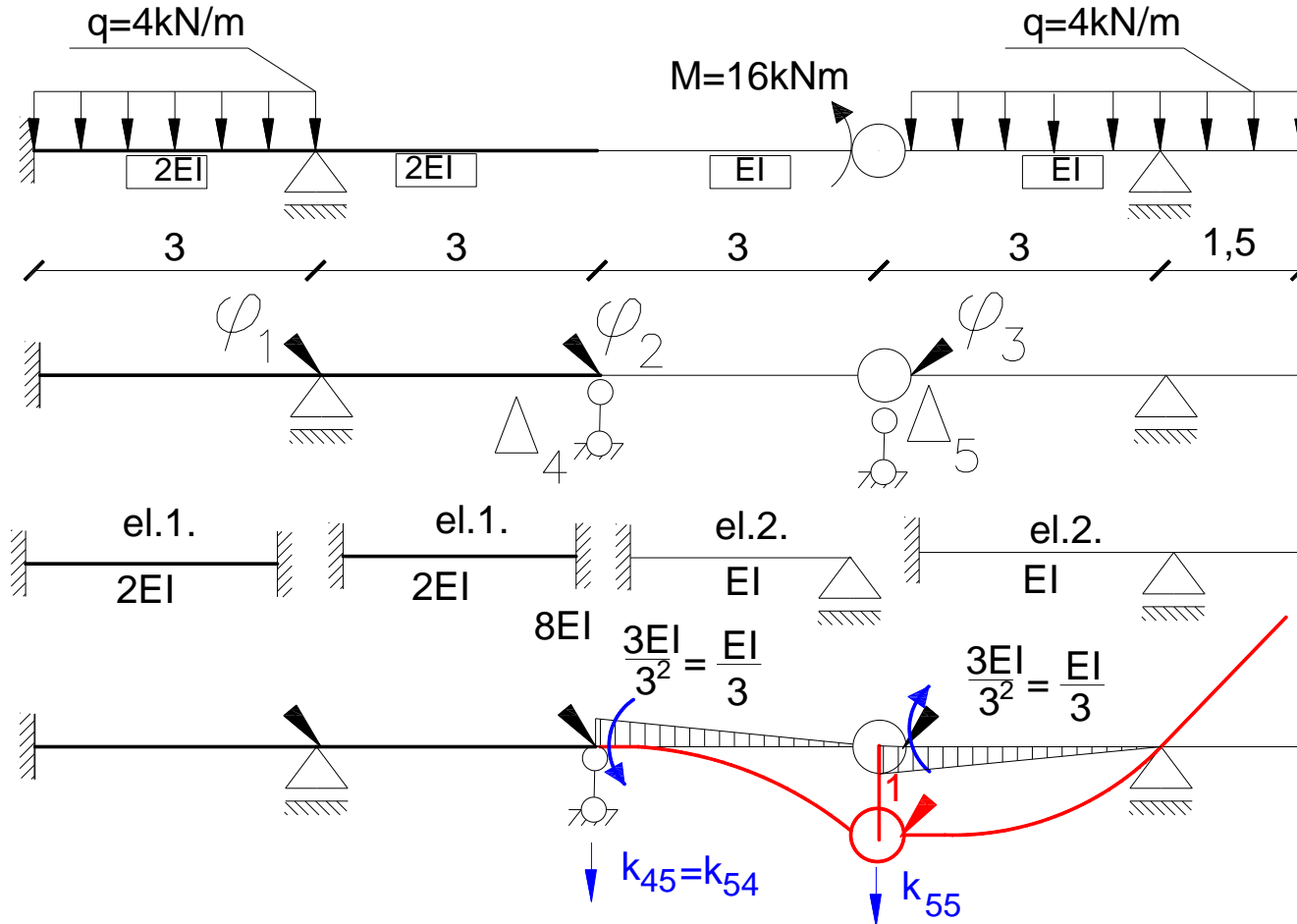

Stan  $\Delta_5=1$

$$k_{15} = 0$$

$$k_{35} = \frac{EI}{3}$$

$$k_{25} = -\frac{EI}{3}$$

# Wykresy jednostkowe:

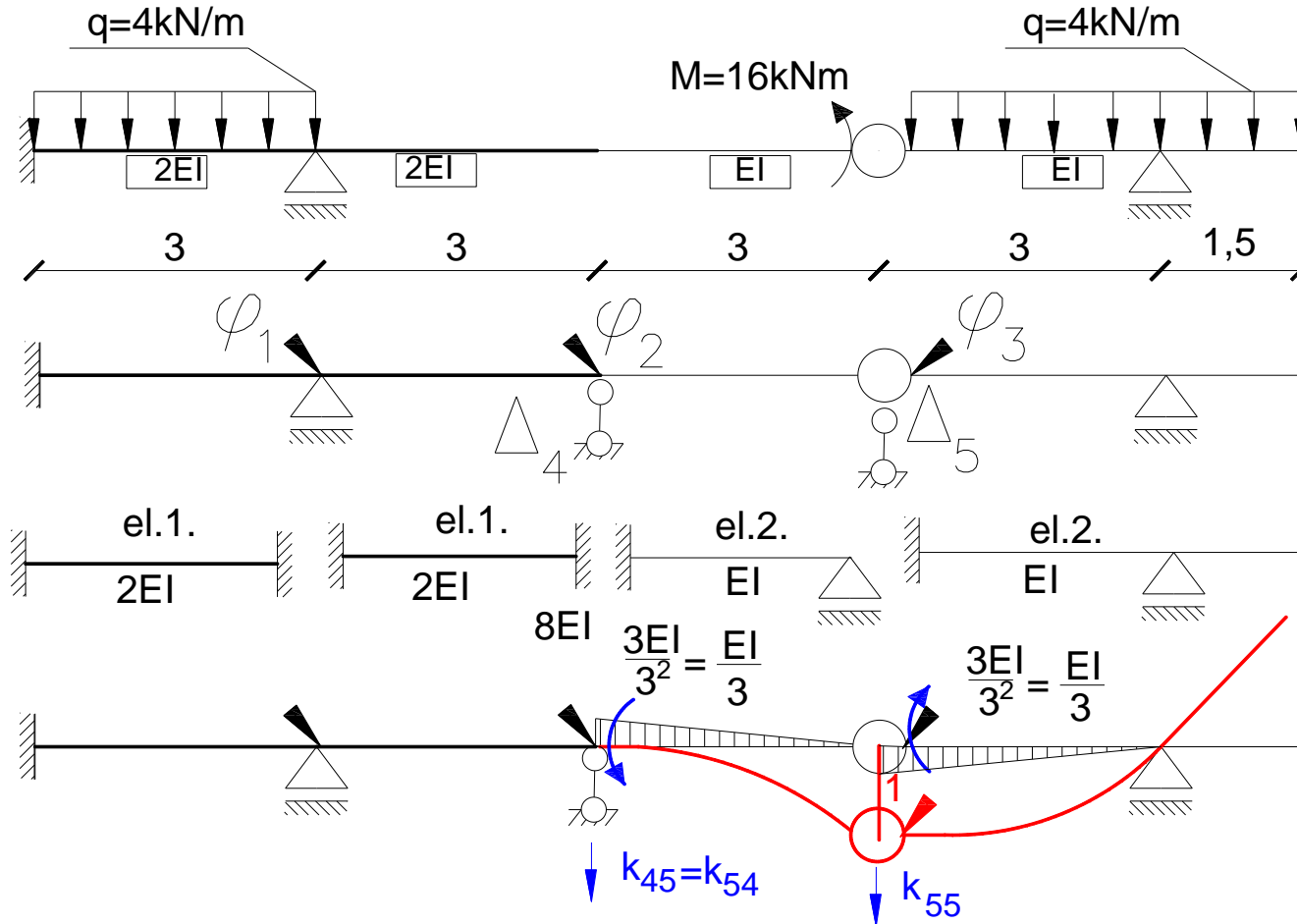

Stan  $\Delta_5=1$

$$k_{15} = 0$$

$$k_{25} = -\frac{EI}{3}$$

$$k_{35} = \frac{EI}{3}$$

$$k_{45} = k_{54}$$

$$k_{55}$$

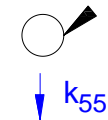

$$k_{55}$$

3

3

# Wykresy jednostkowe:

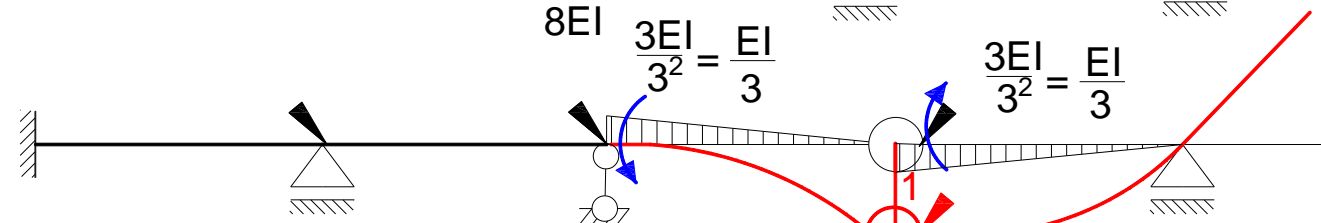
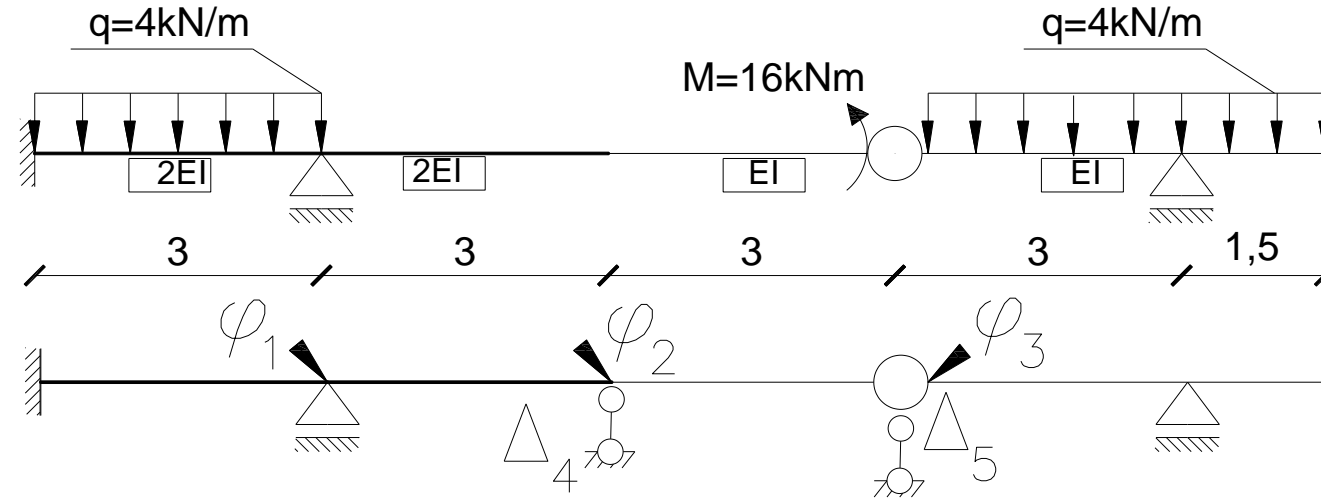

Stan  $\Delta_5=1$

$$k_{15} = 0$$

$$k_{25} = -\frac{EI}{3}$$

$$k_{35} = \frac{EI}{3}$$

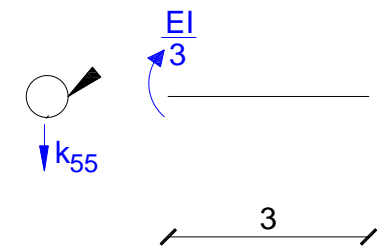

# Wykresy jednostkowe:

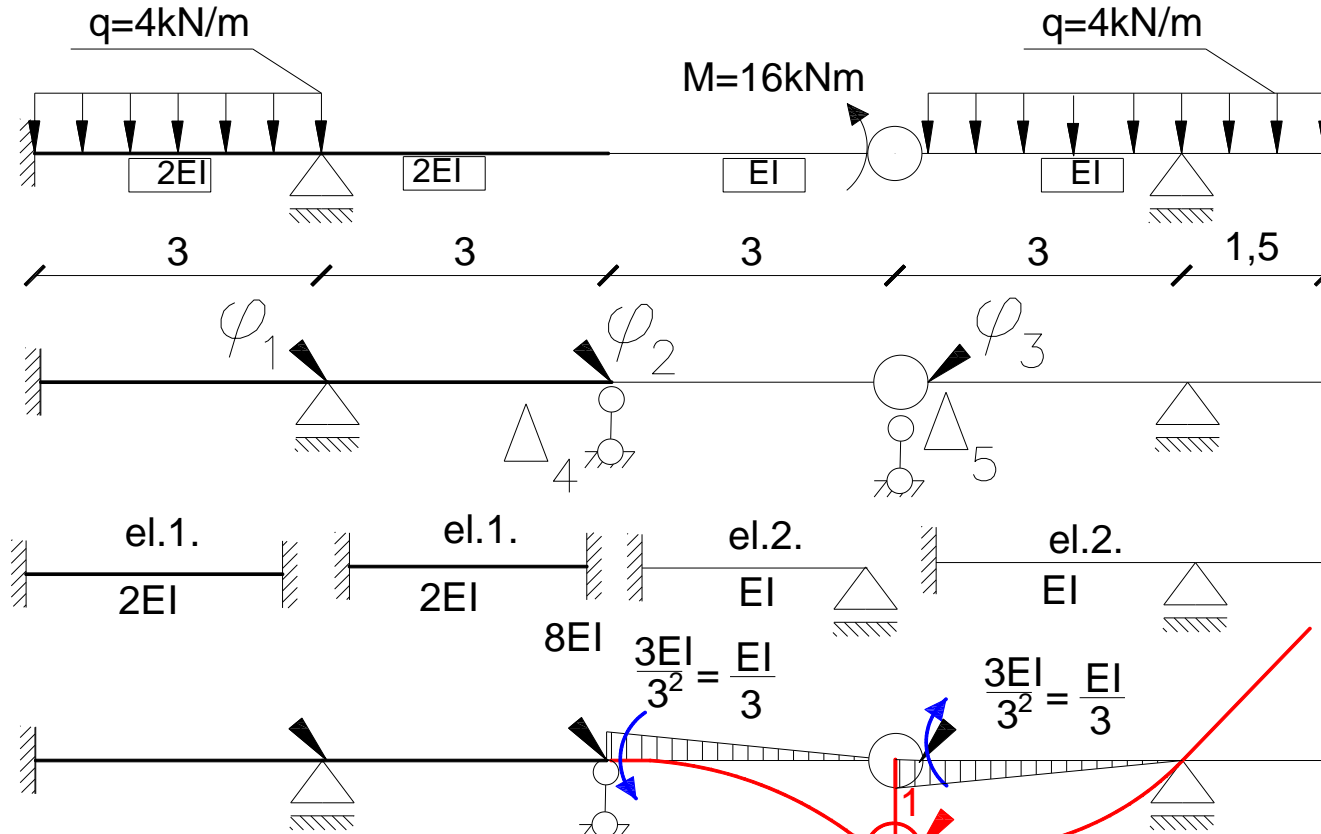

Stan  $\Delta_5=1$

$$k_{15} = 0$$

$$k_{25} = -\frac{EI}{3}$$

$$k_{35} = \frac{EI}{3}$$

$$k_{45} = k_{54}$$

$$k_{55}$$

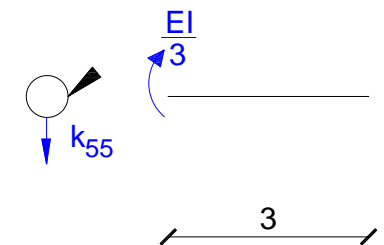
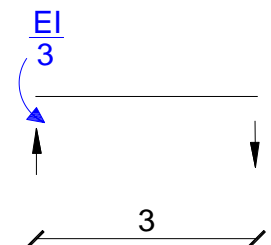

# Wykresy jednostkowe:

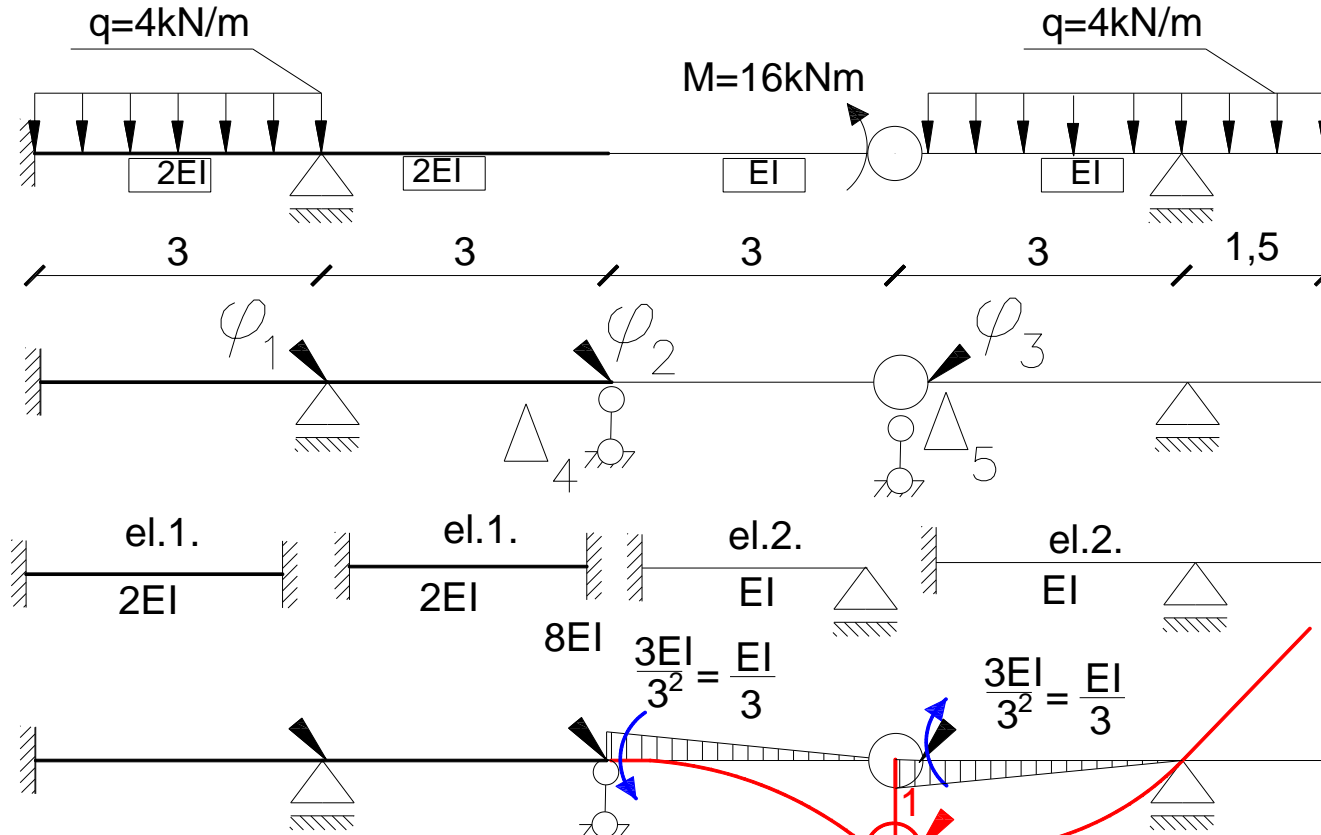

Stan  $\Delta_5=1$

$$k_{15} = 0$$

$$k_{25} = -\frac{EI}{3}$$

$$k_{35} = \frac{EI}{3}$$

$$k_{45} = k_{54}$$

$$k_{55}$$

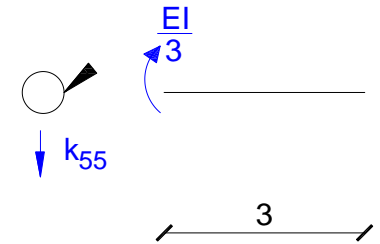
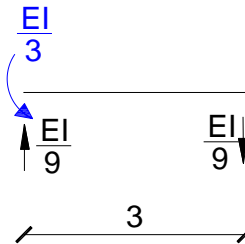

# Wykresy jednostkowe:

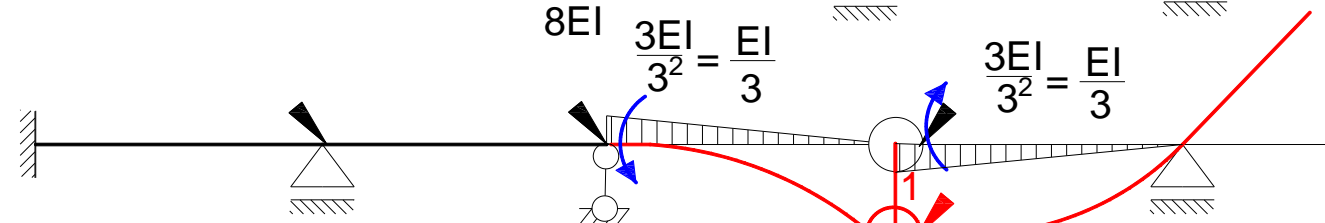
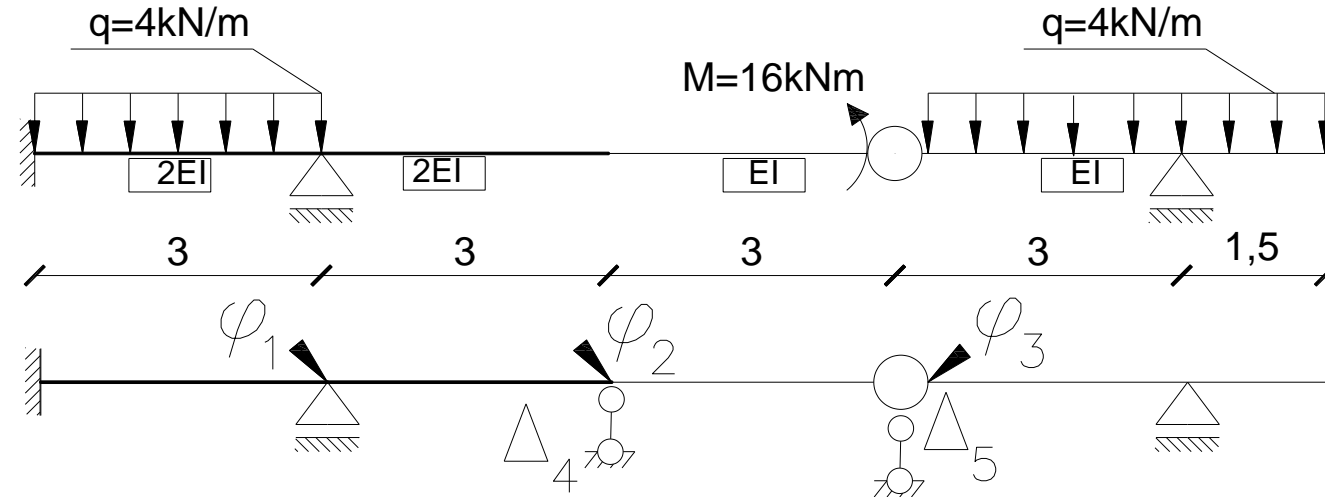

Stan  $\Delta_5=1$

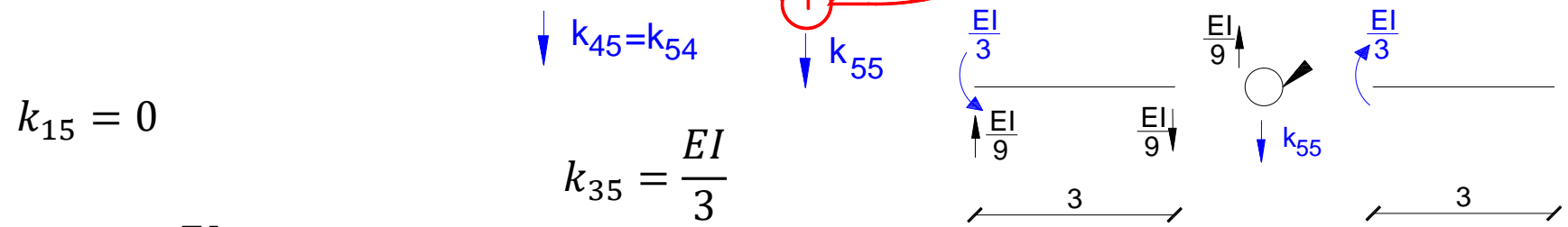

$$k_{15} = 0$$

$$k_{25} = -\frac{EI}{3}$$

$$k_{35} = \frac{EI}{3}$$

# Wykresy jednostkowe:

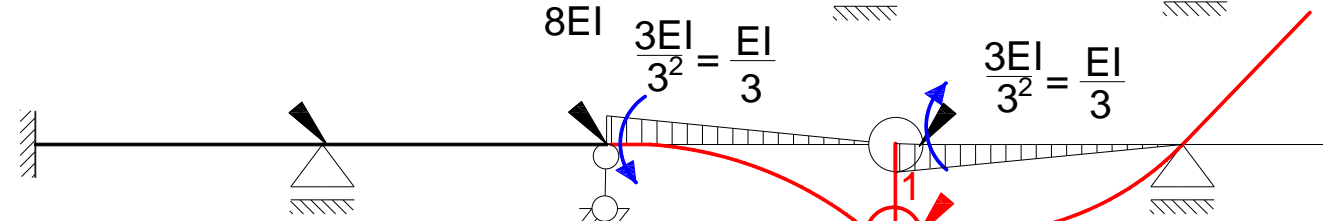
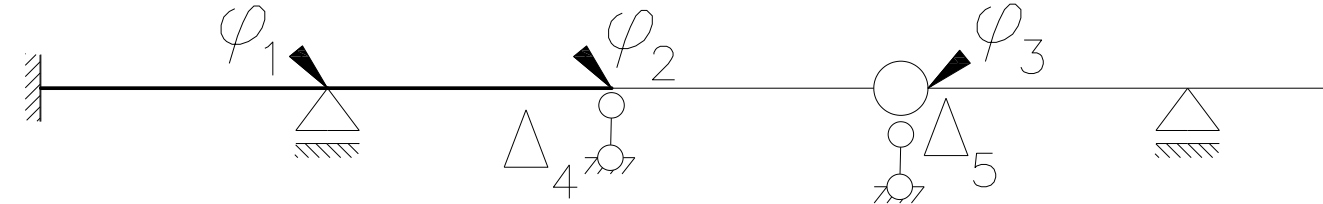
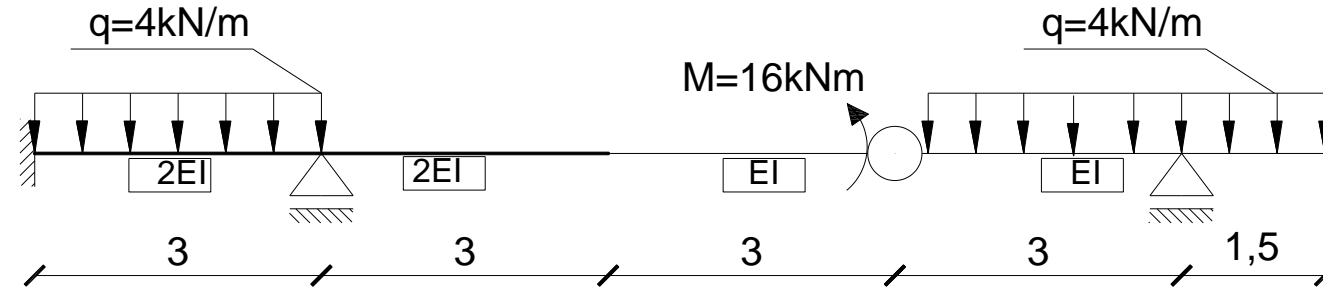

Stan  $\Delta_5=1$

$$k_{15} = 0$$

$$k_{25} = -\frac{EI}{3}$$

$$k_{35} = \frac{EI}{3}$$

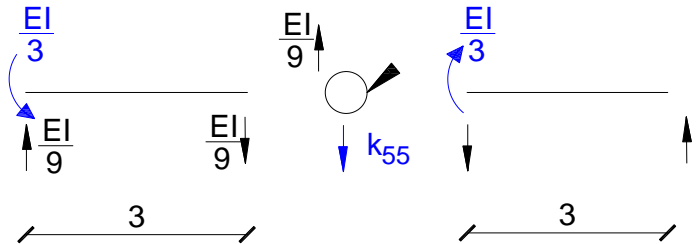

# Wykresy jednostkowe:

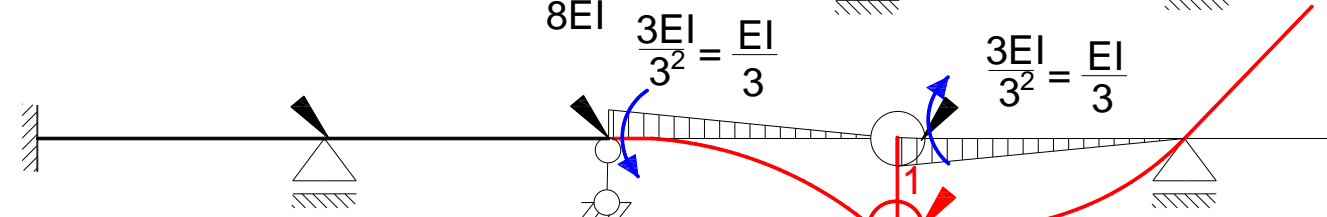
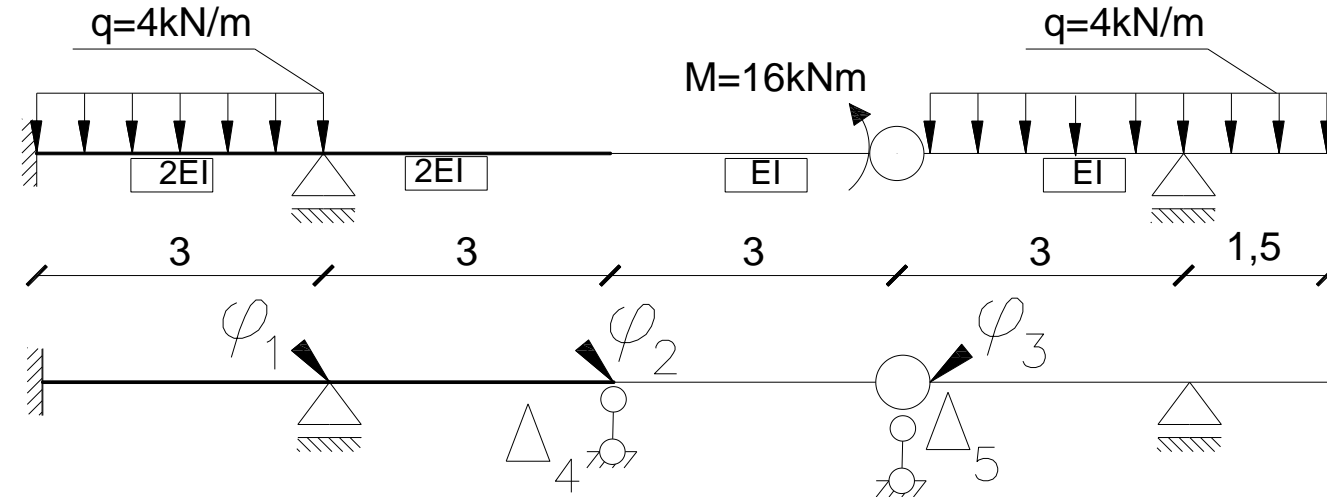

Stan  $\Delta_5=1$

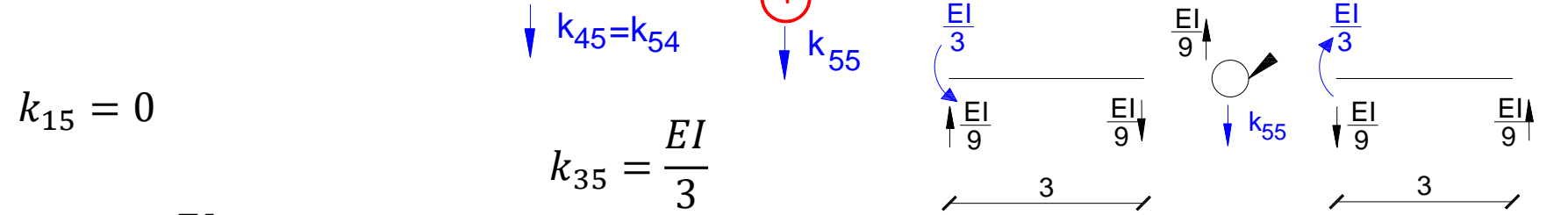

$$k_{15} = 0$$

$$k_{25} = -\frac{EI}{3}$$

$$k_{35} = \frac{EI}{3}$$

$$k_{45} = k_{54}$$

$$k_{55}$$

$$\frac{EI}{9}$$

$$\frac{EI}{3}$$



# Wykresy jednostkowe:

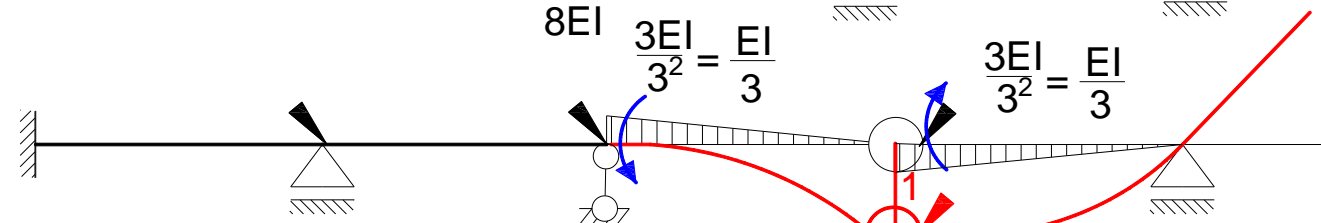
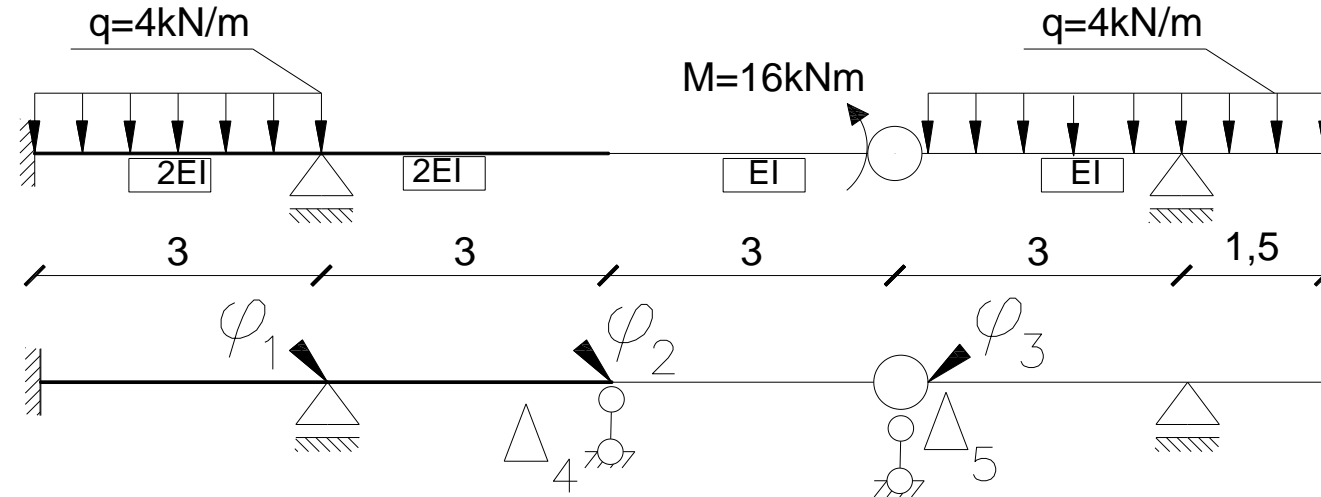

Stan  $\Delta_5=1$

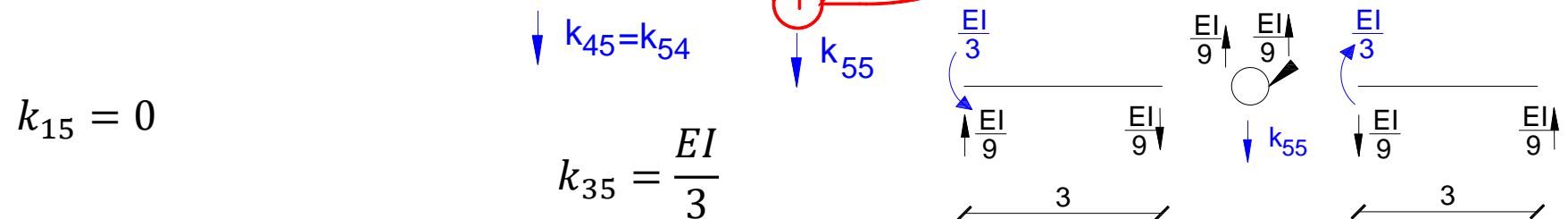

$$k_{15} = 0$$

$$k_{35} = \frac{EI}{3}$$

$$k_{25} = -\frac{EI}{3}$$

# Wykresy jednostkowe:

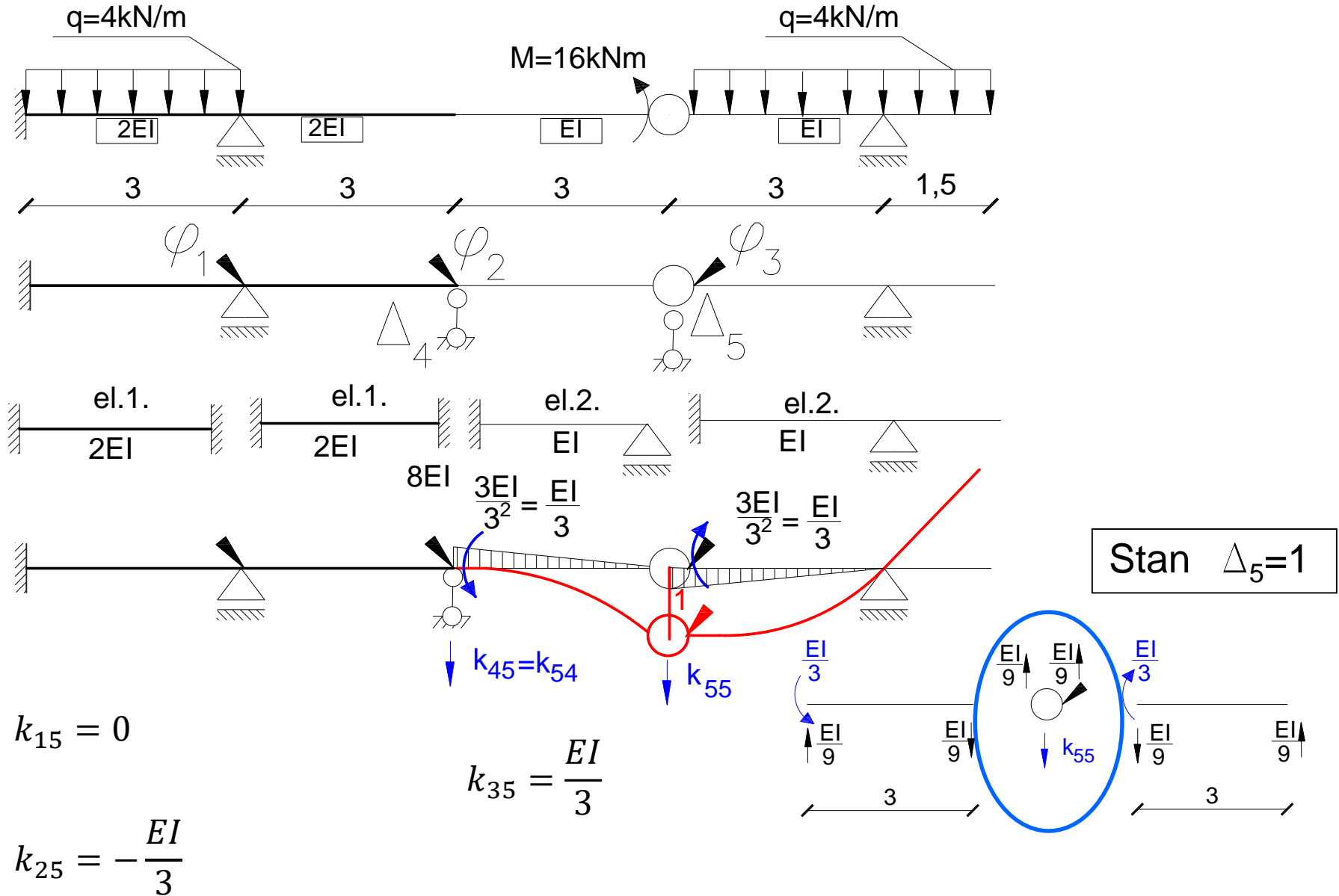

# Wykresy jednostkowe:

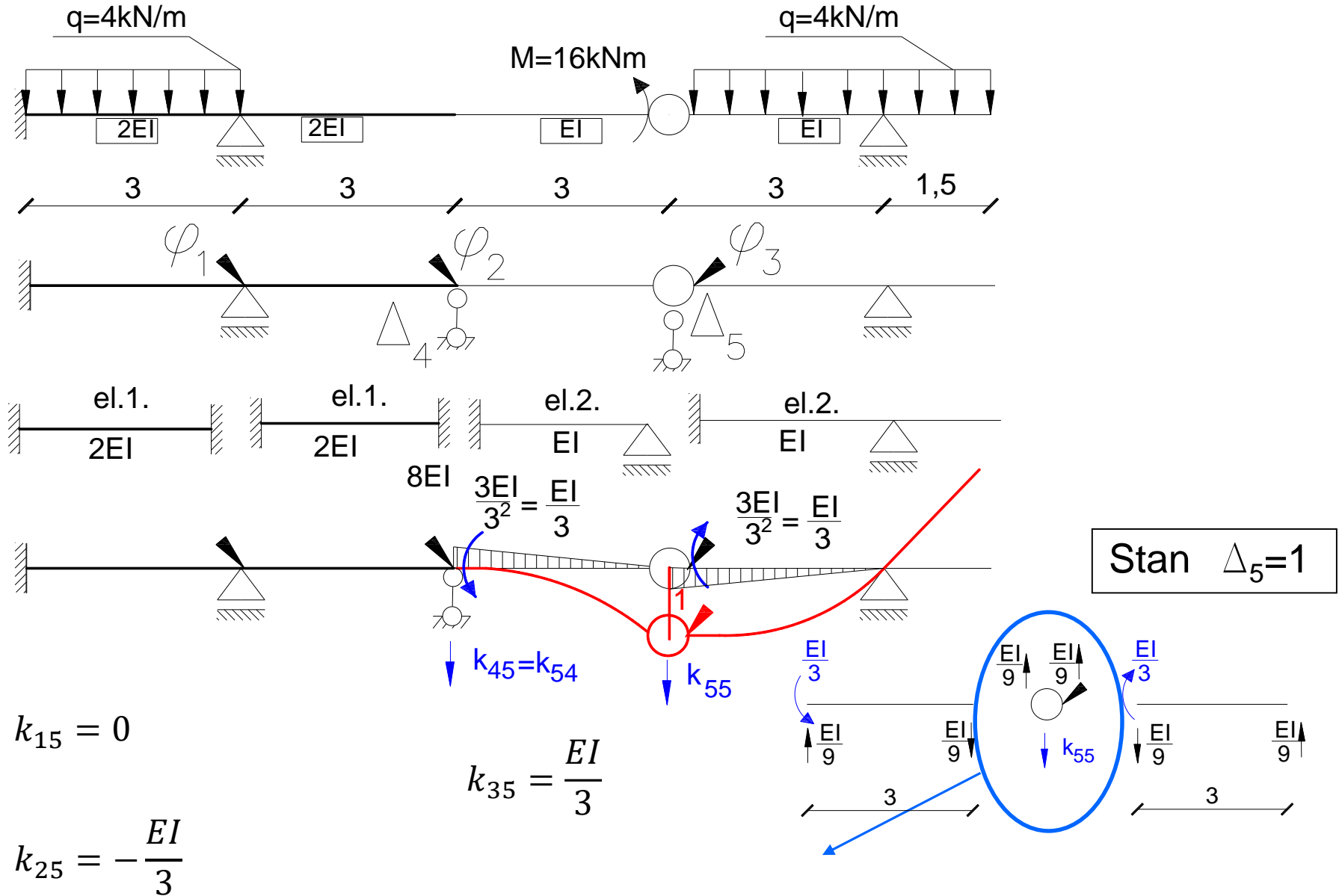

Stan  $\Delta_5=1$

# Wykresy jednostkowe:

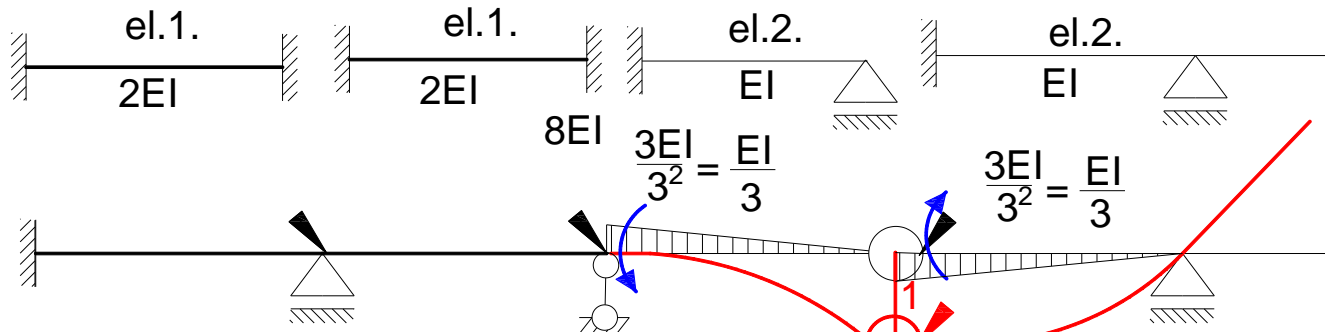
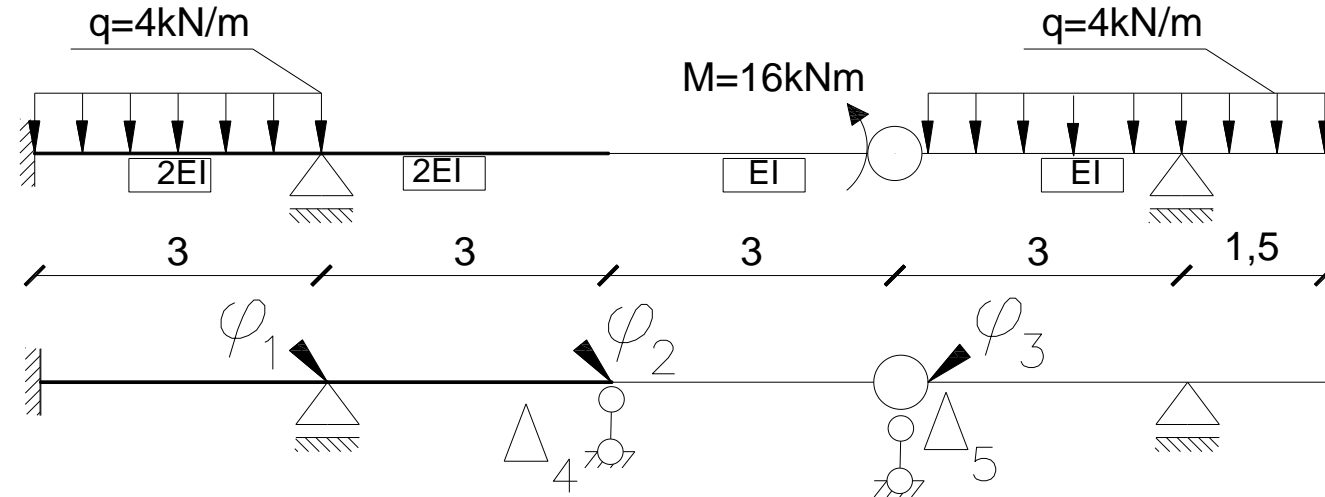

Stan  $\Delta_5=1$

$$k_{15} = 0$$

$$k_{35} = \frac{EI}{3}$$

$$k_{25} = -\frac{EI}{3}$$

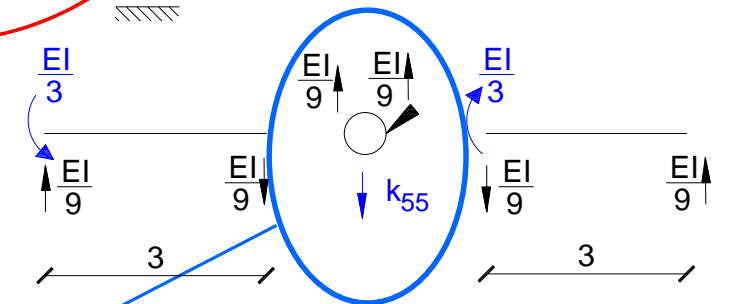

$$\sum R_y = \frac{EI}{9} + \frac{EI}{9} - k_{55} = 0 \rightarrow k_{55} = \frac{2EI}{9} \quad \text{dr inż. Hanna Weber}$$

# Wykresy od obciążenia zewnętrznego

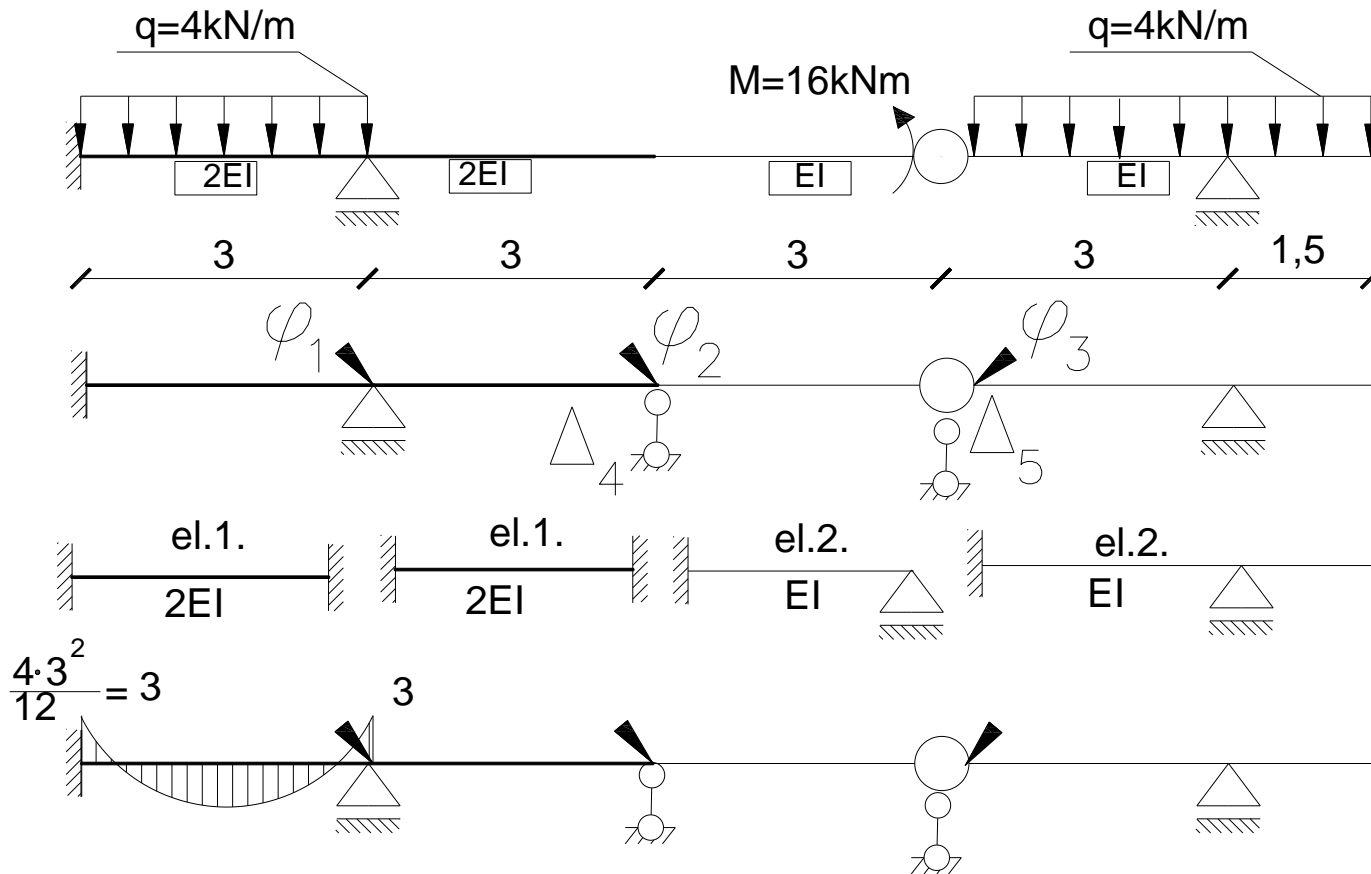

С. С. БОДУК 17.1.

1	2	3	4
6		$-\frac{ql^2}{12}$	$\frac{ql^2}{12}$

# Wykresy od obciążenia zewnętrznego

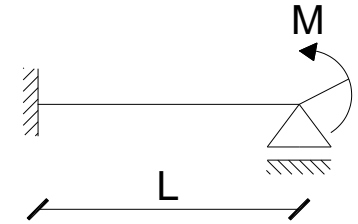
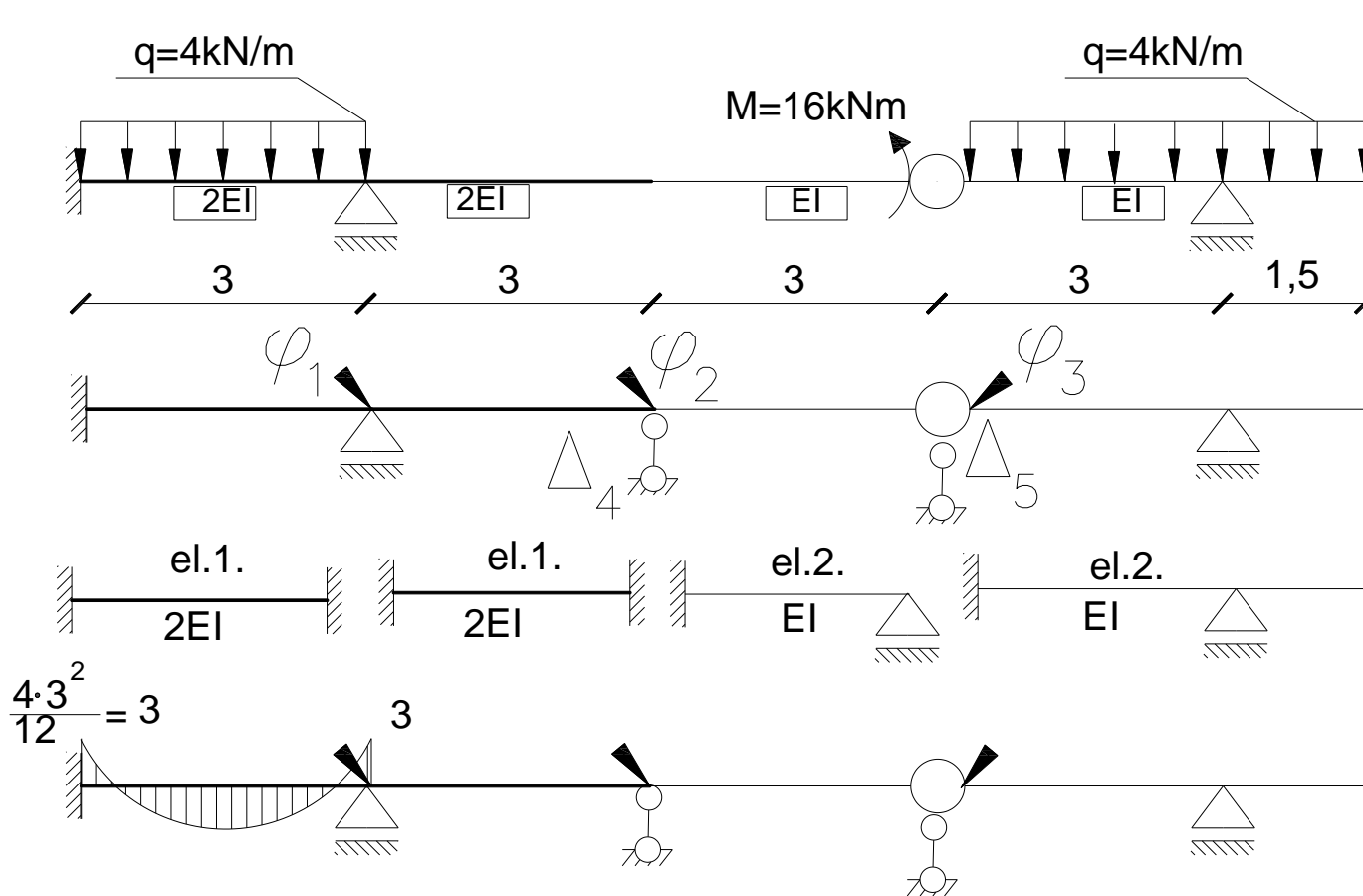

# Wykresy od obciążenia zewnętrznego

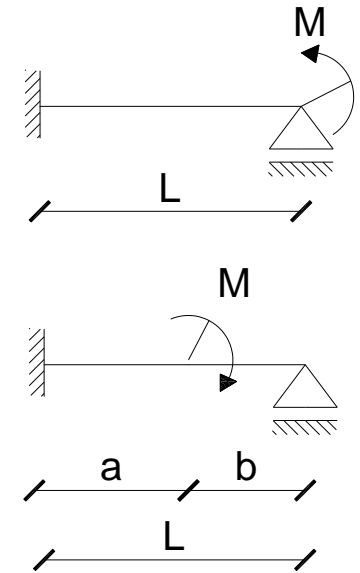
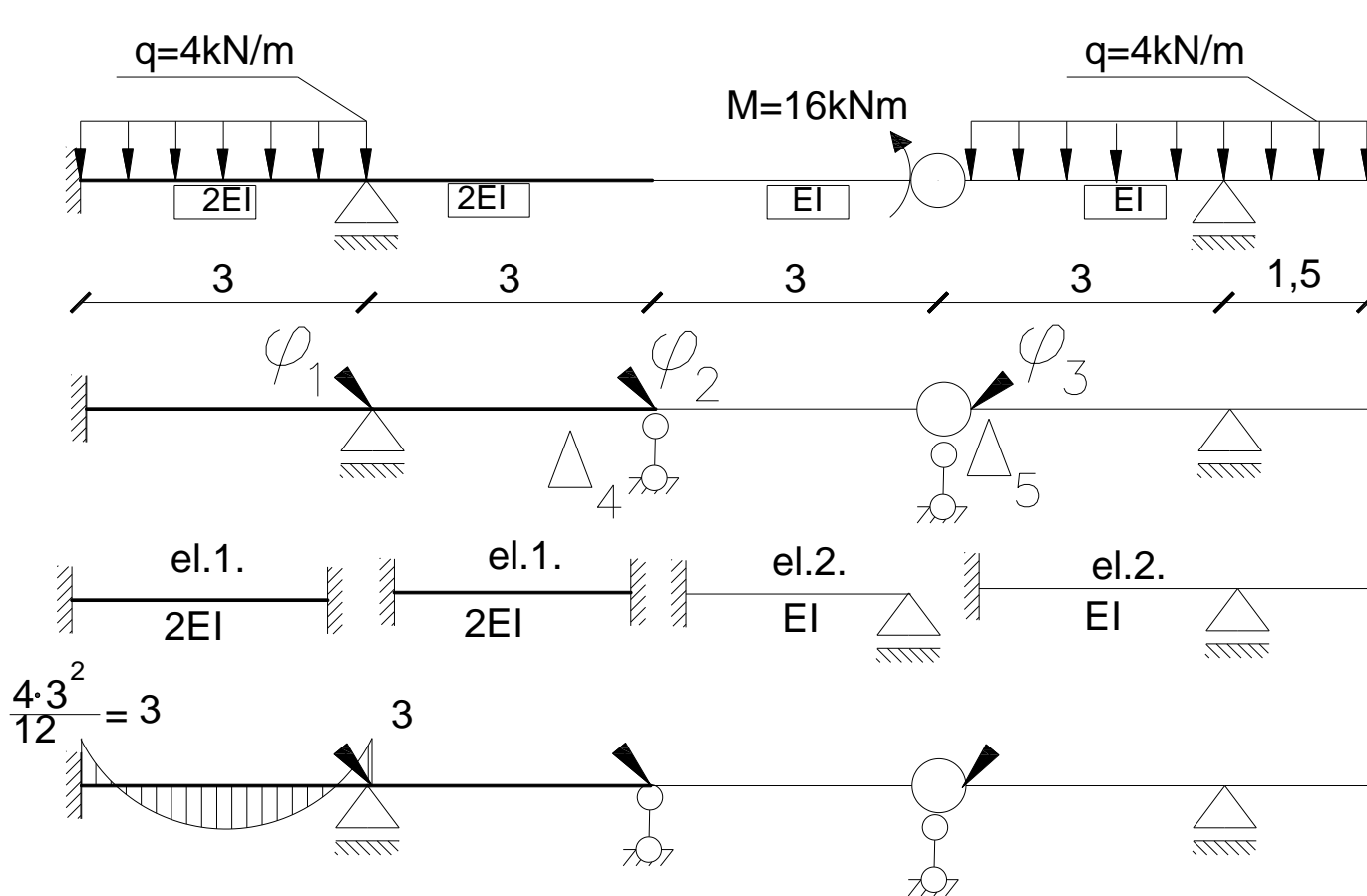

# Wykresy od obciążenia zewnętrznego

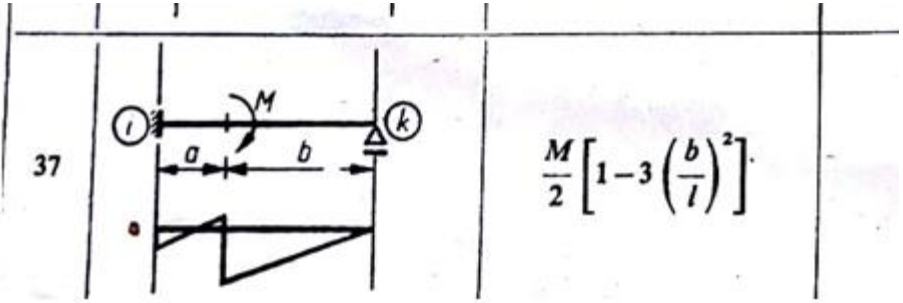
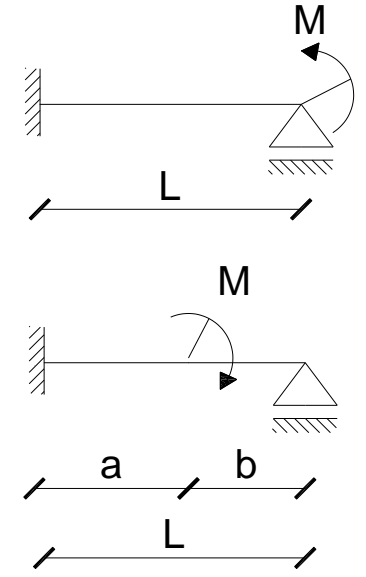
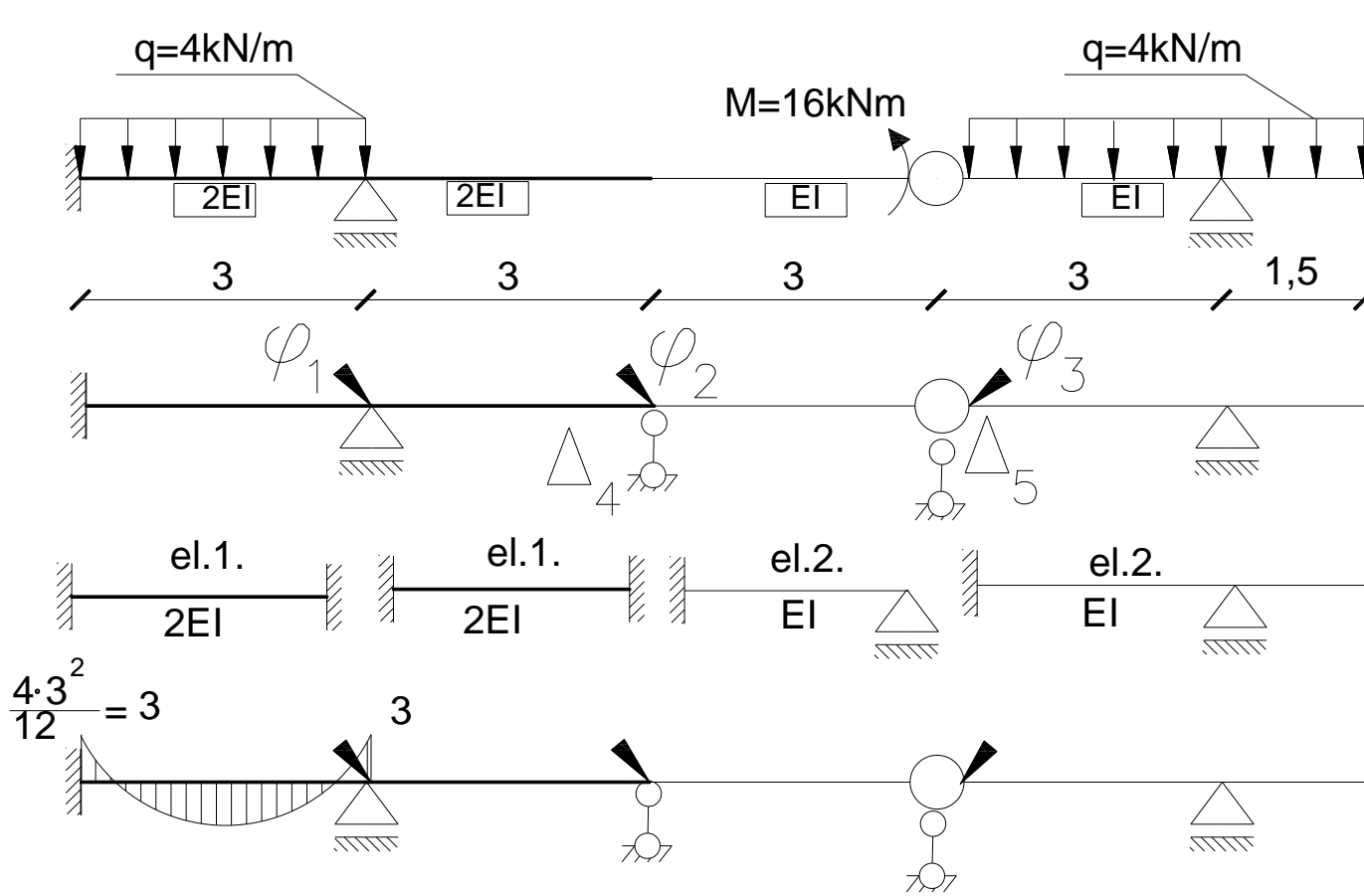



# Wykresy od obciążenia zewnętrznego

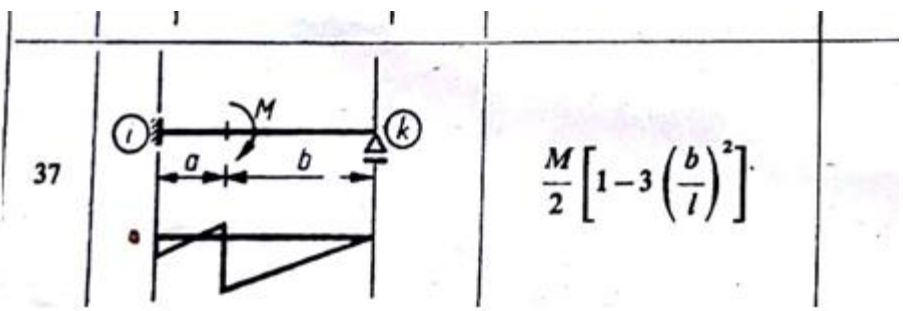
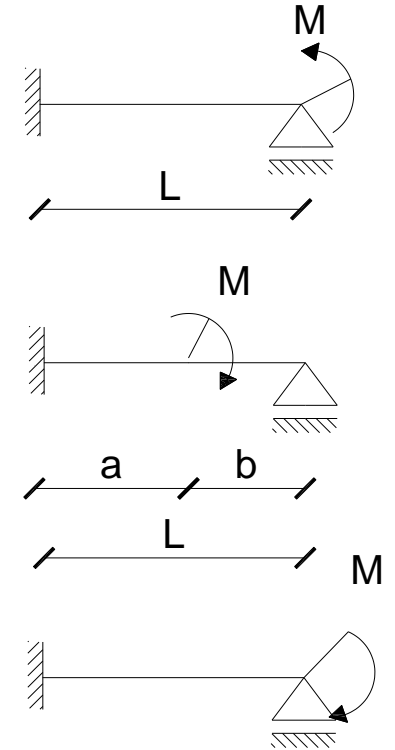
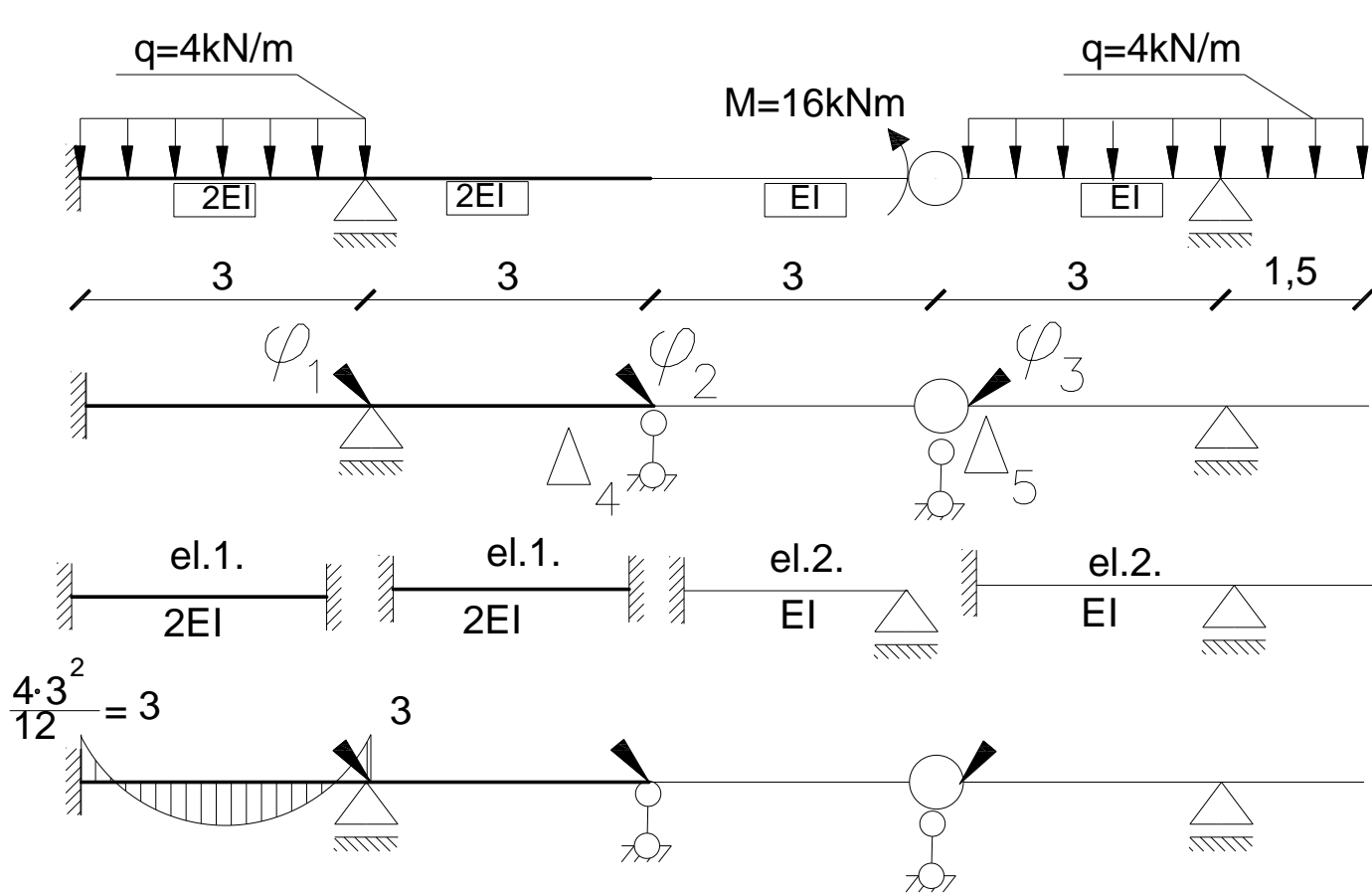

# Wykresy od obciążenia zewnętrznego

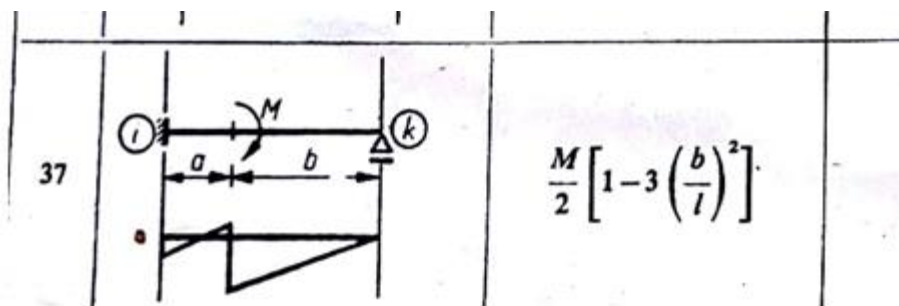
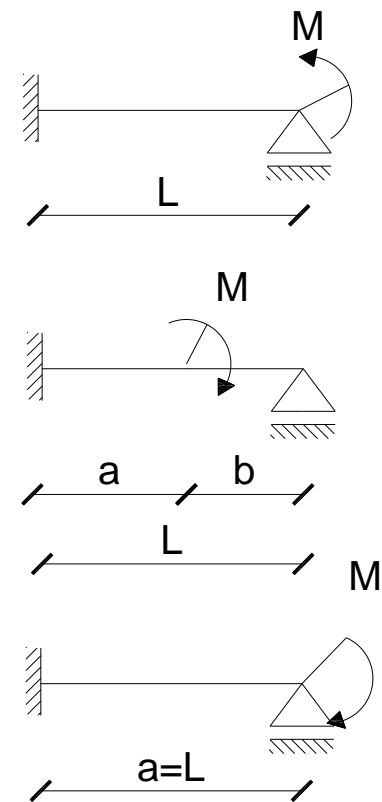
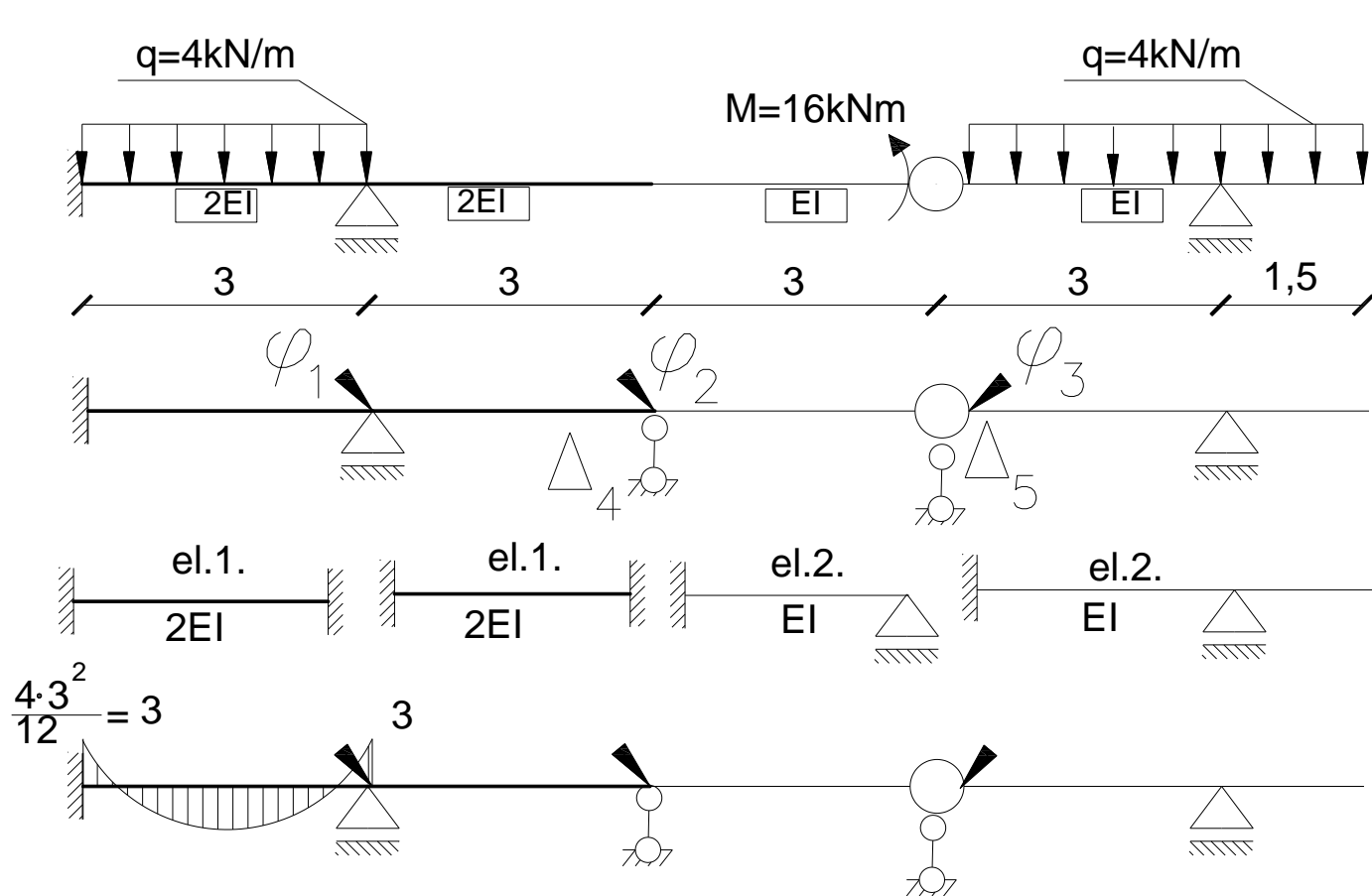

# Wykresy od obciążenia zewnętrznego

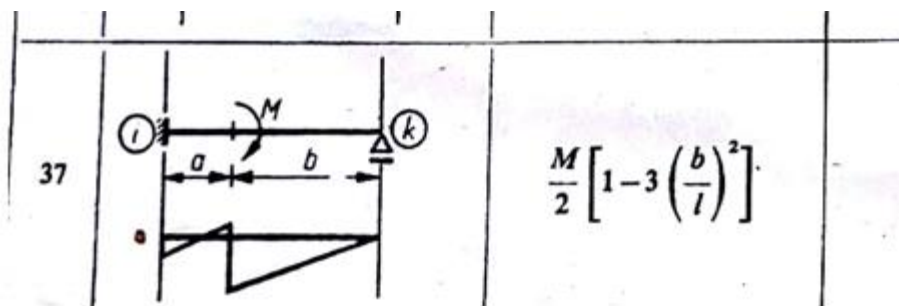
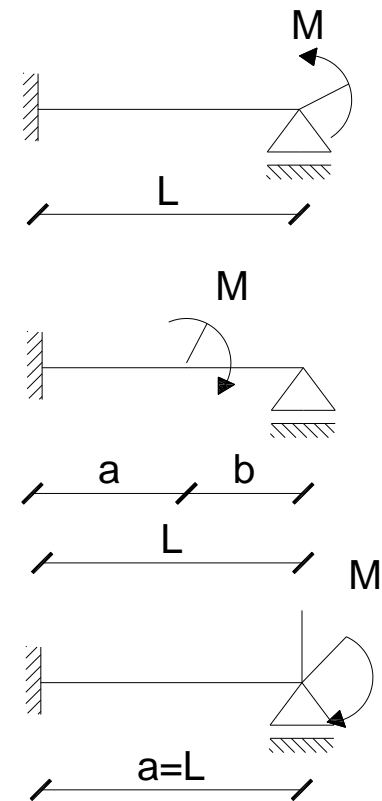
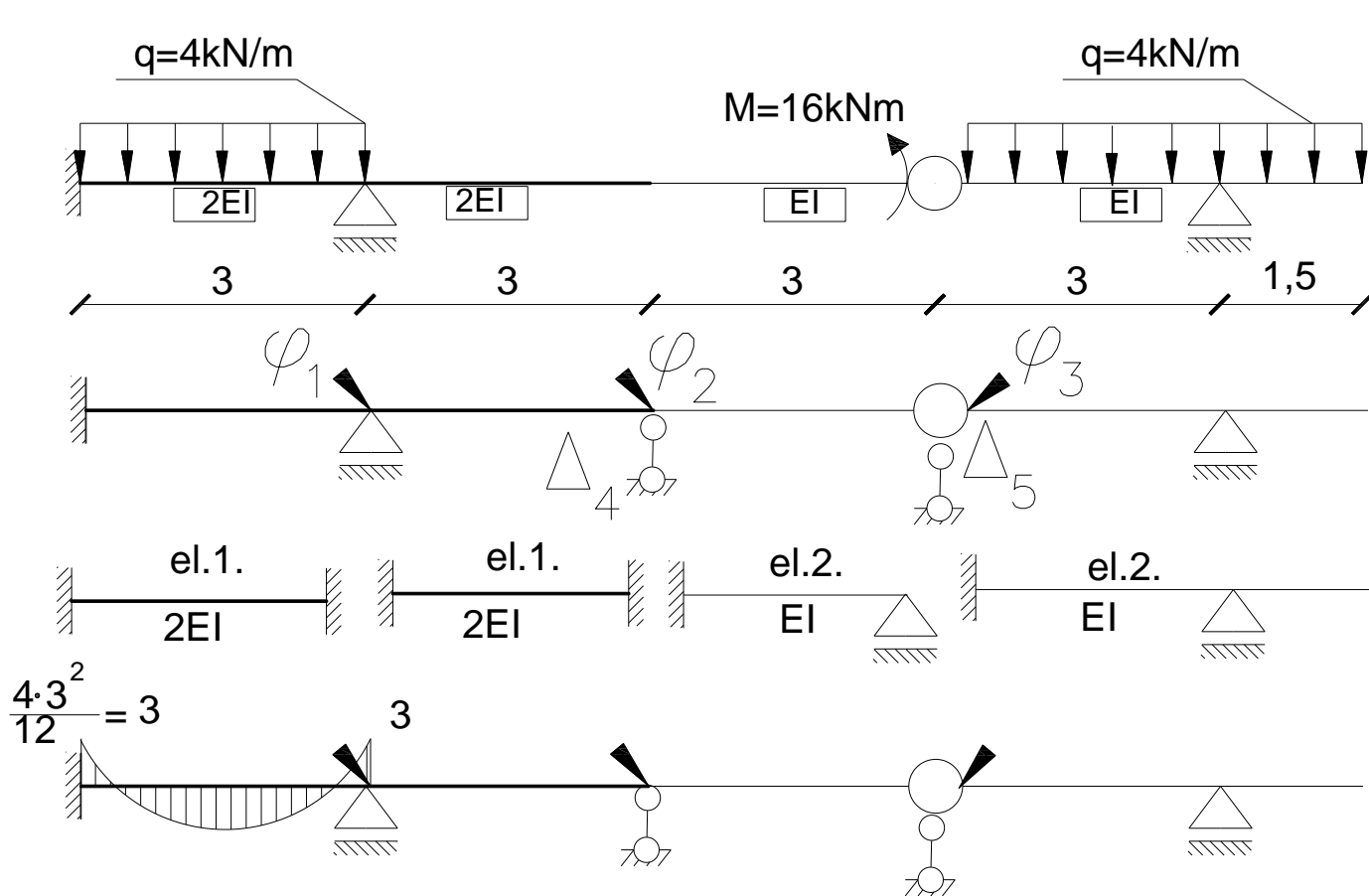

# Wykresy od obciążenia zewnętrznego

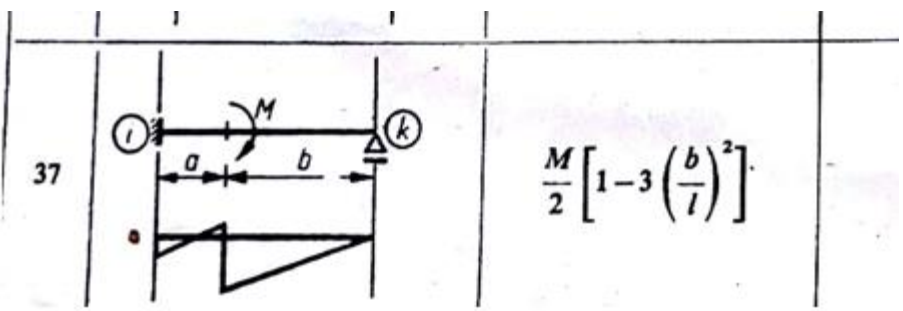
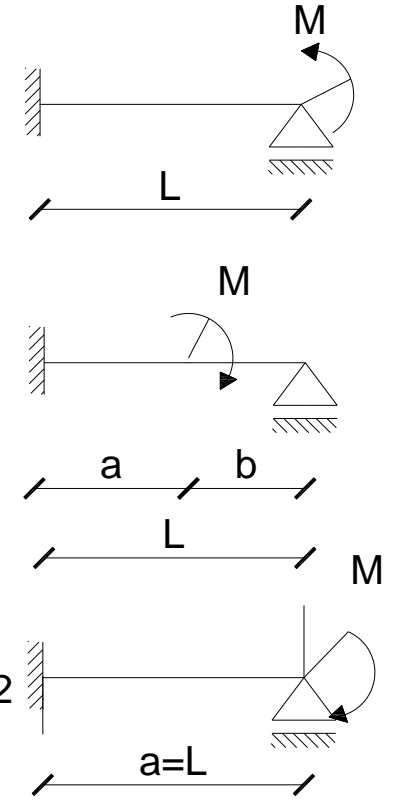
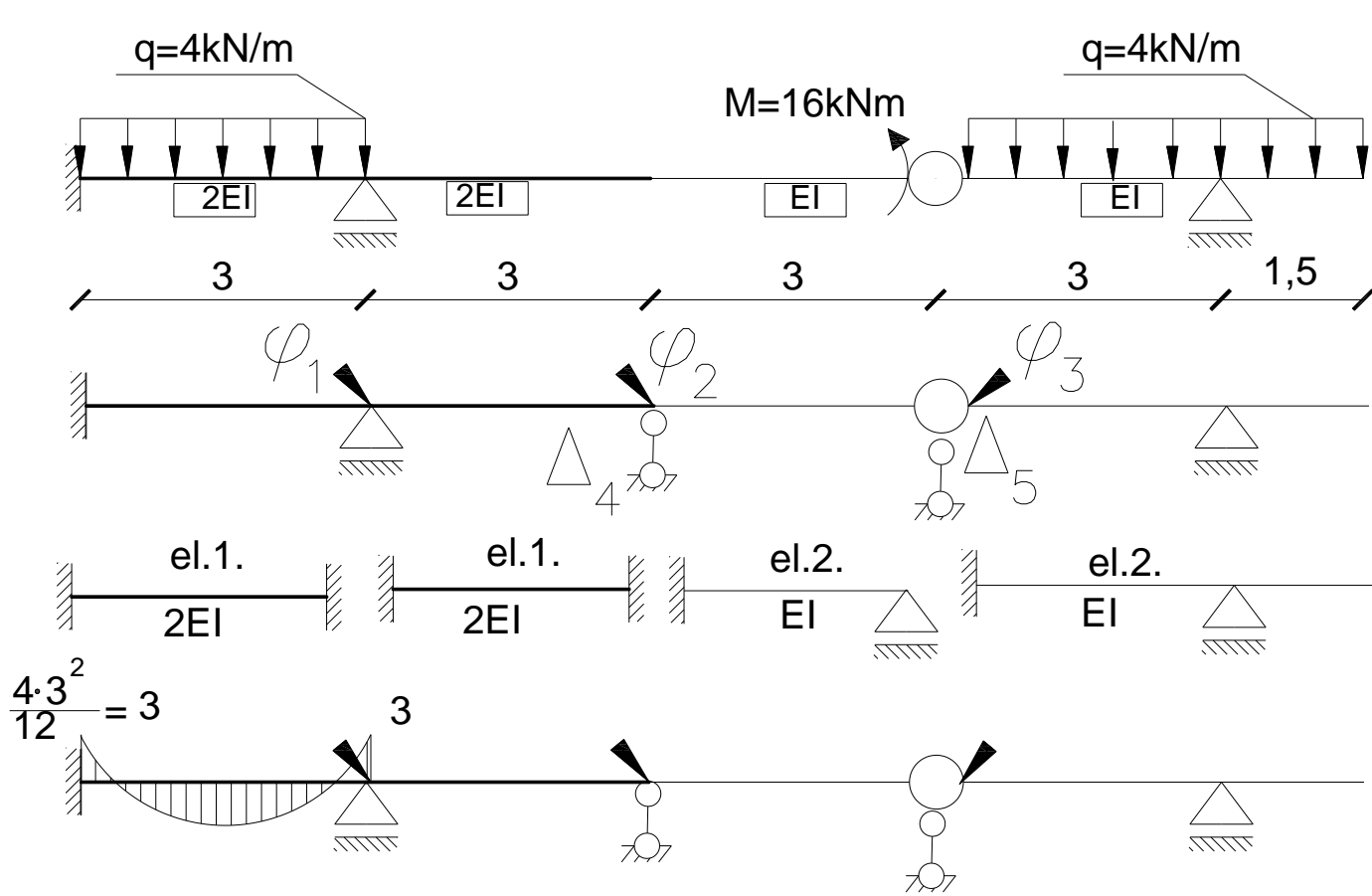

# Wykresy od obciążenia zewnętrznego

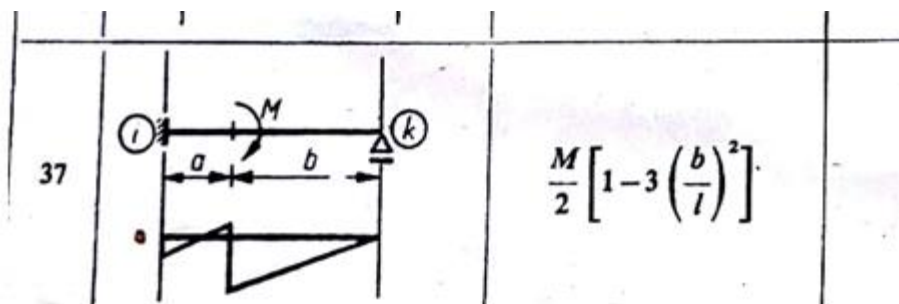
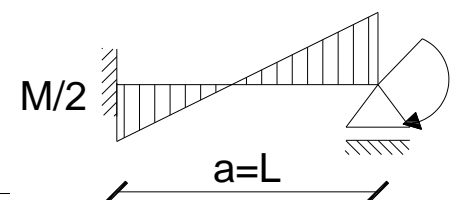
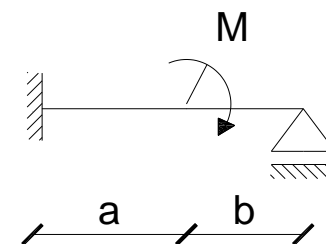
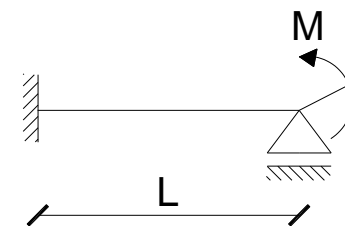
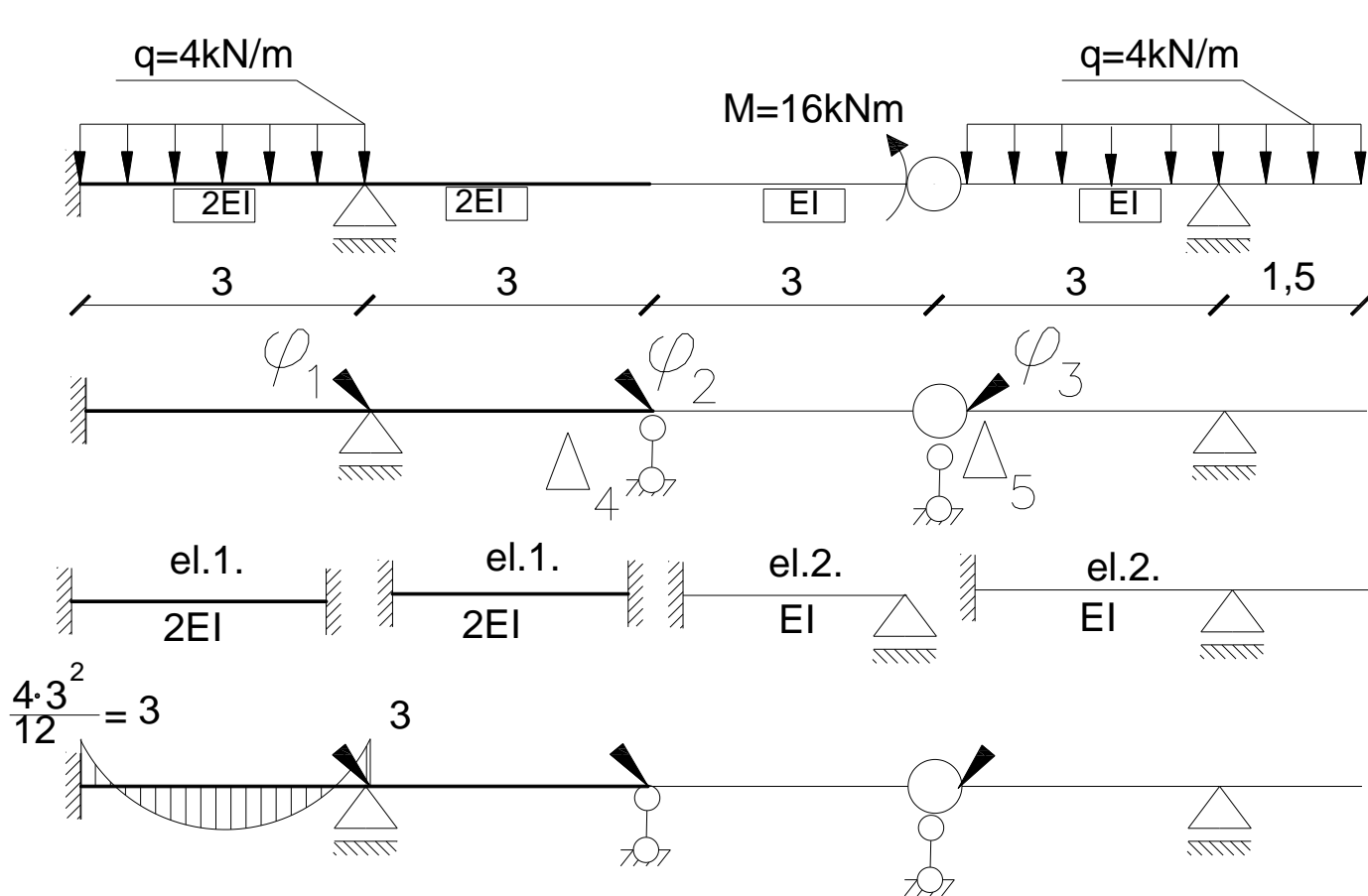

$$\frac{M}{2} \left[ 1 - 3 \left( \frac{b}{l} \right)^2 \right]$$

# Wykresy od obciążenia zewnętrznego

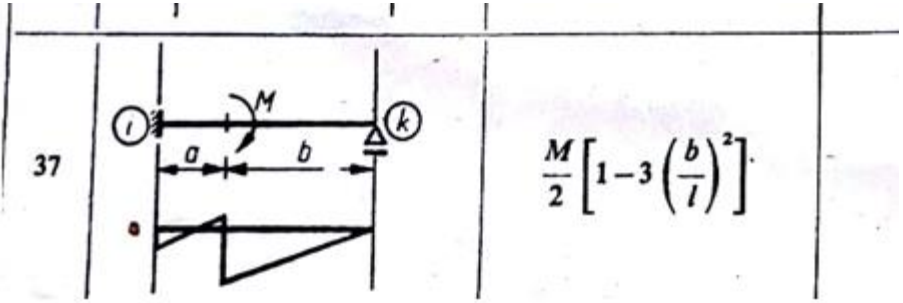
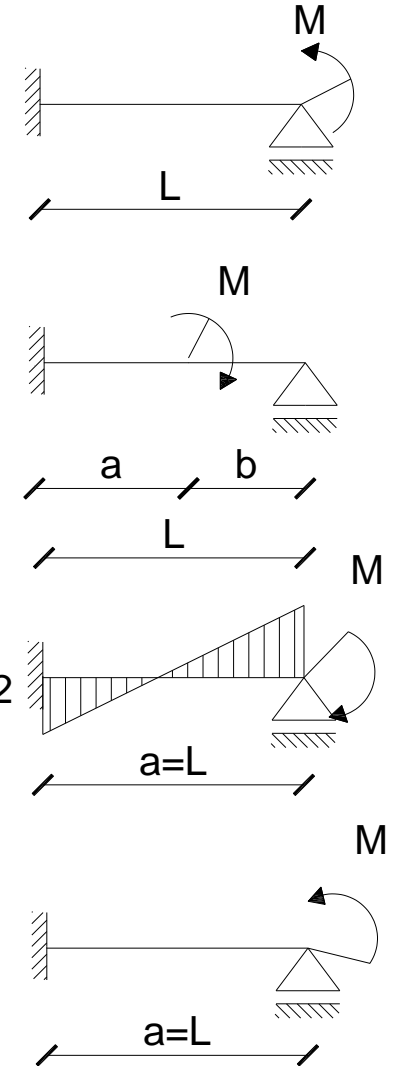
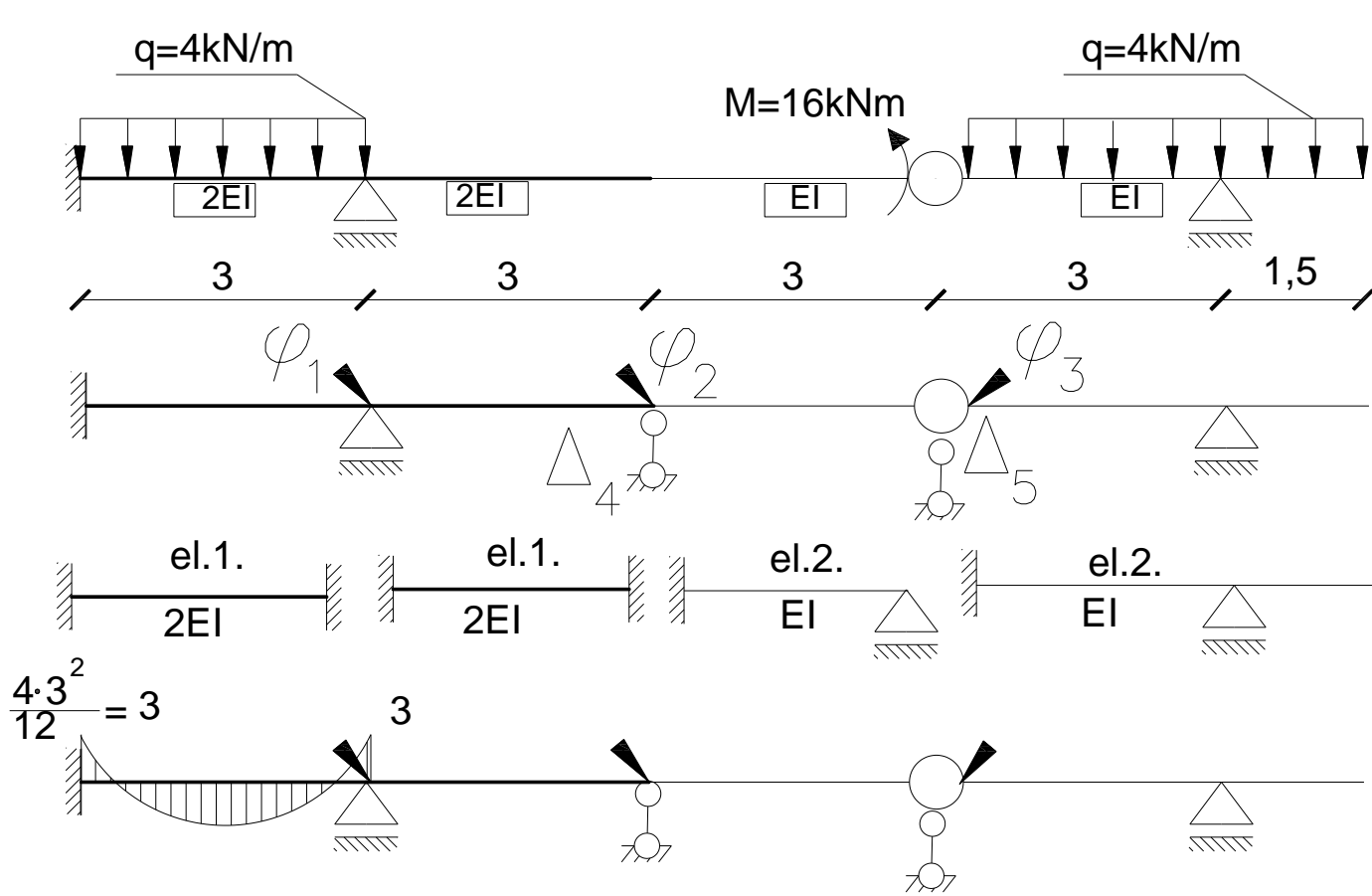

# Wykresy od obciążenia zewnętrznego

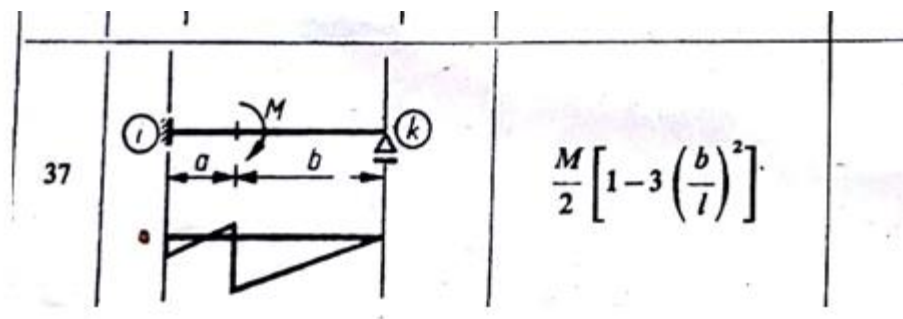
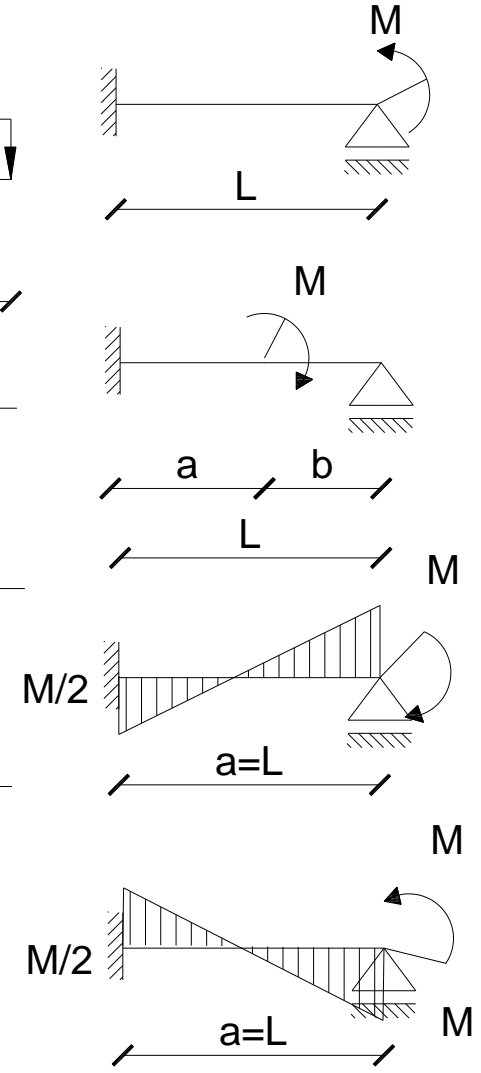
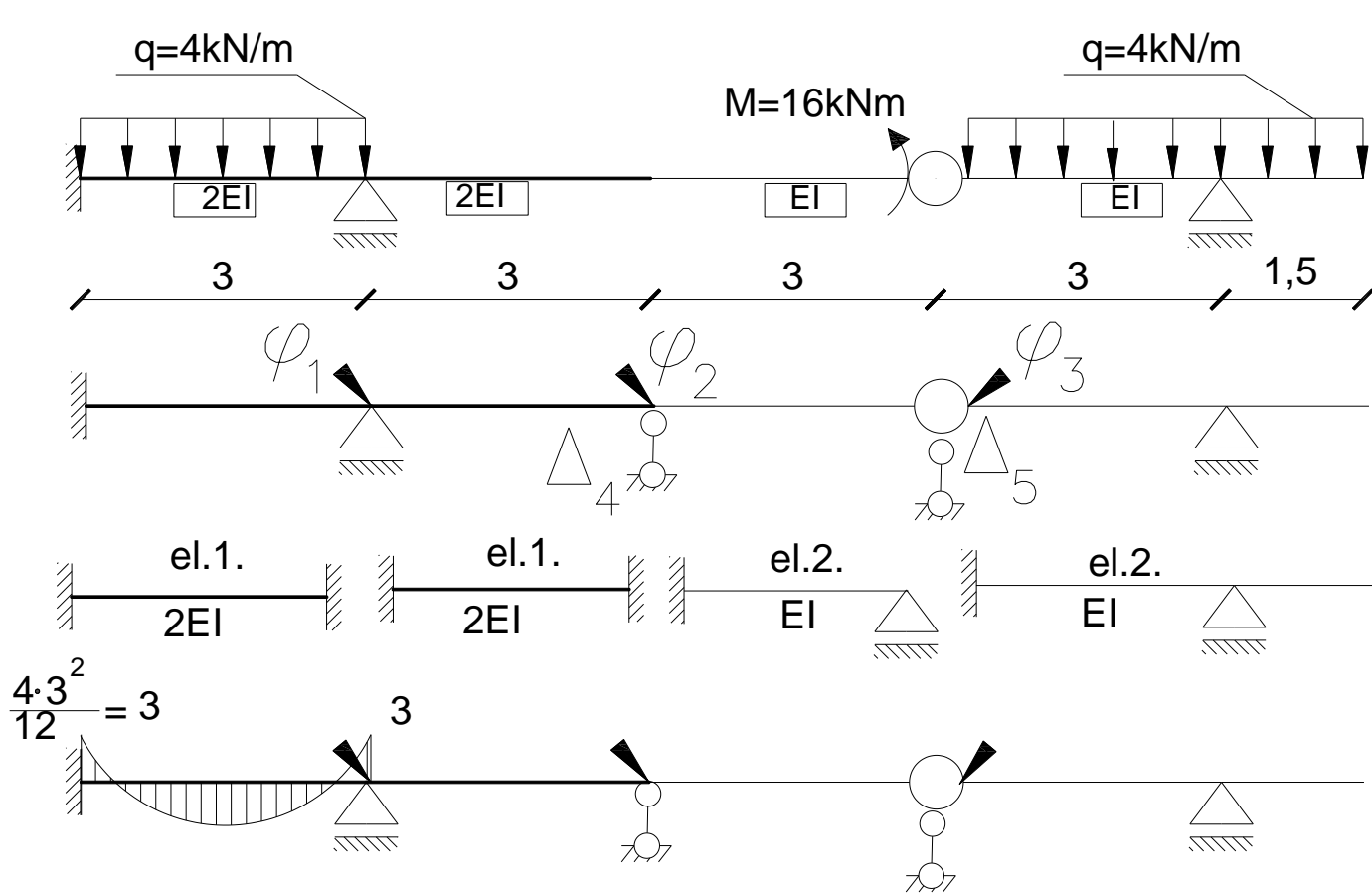

# Wykresy od obciążenia zewnętrznego

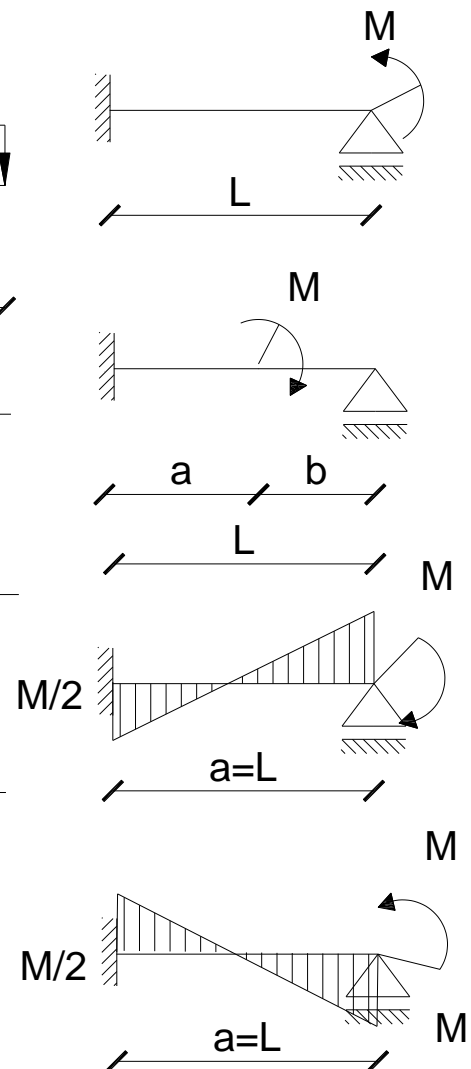
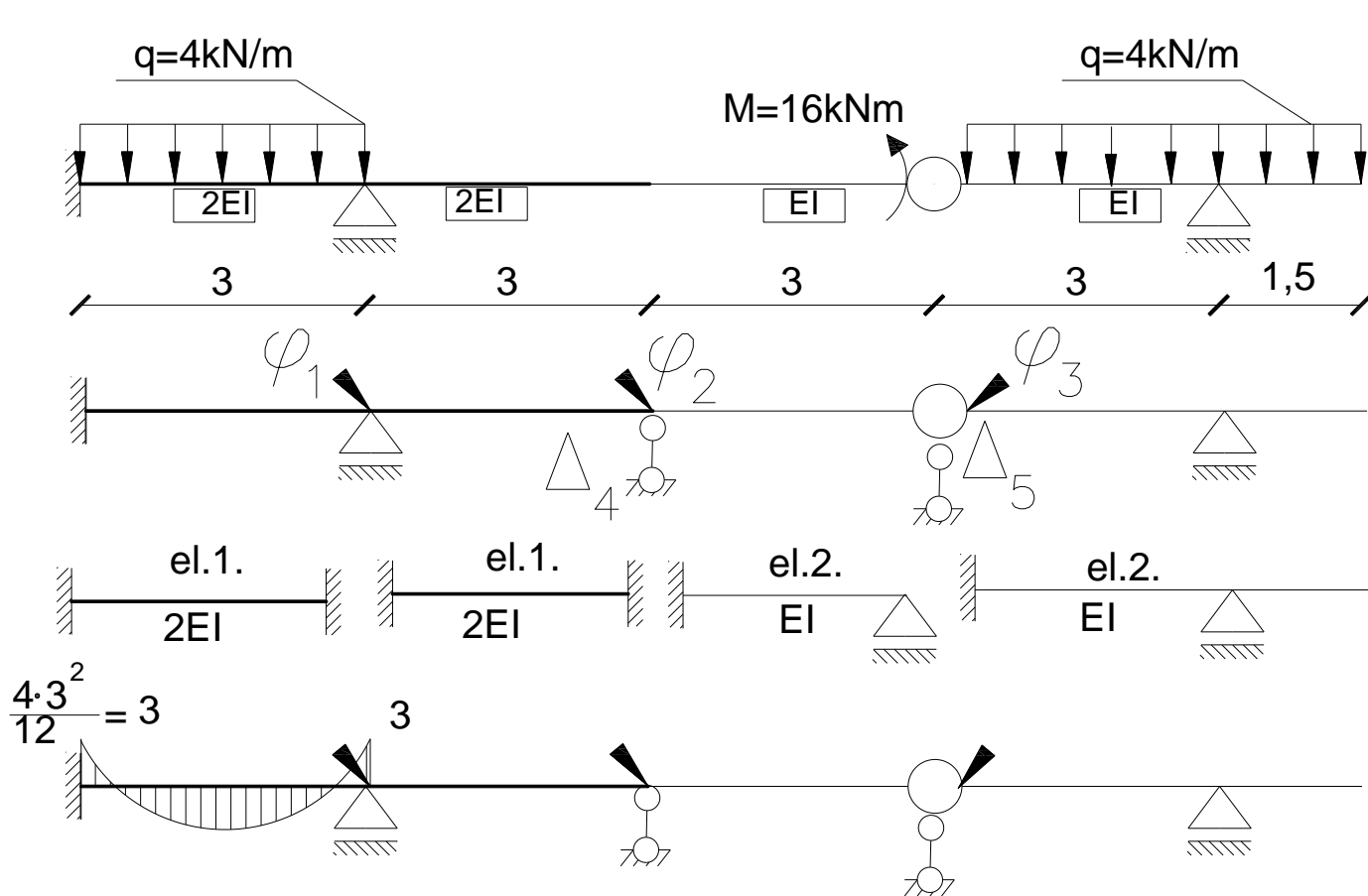



# Wykresy od obciążenia zewnętrznego

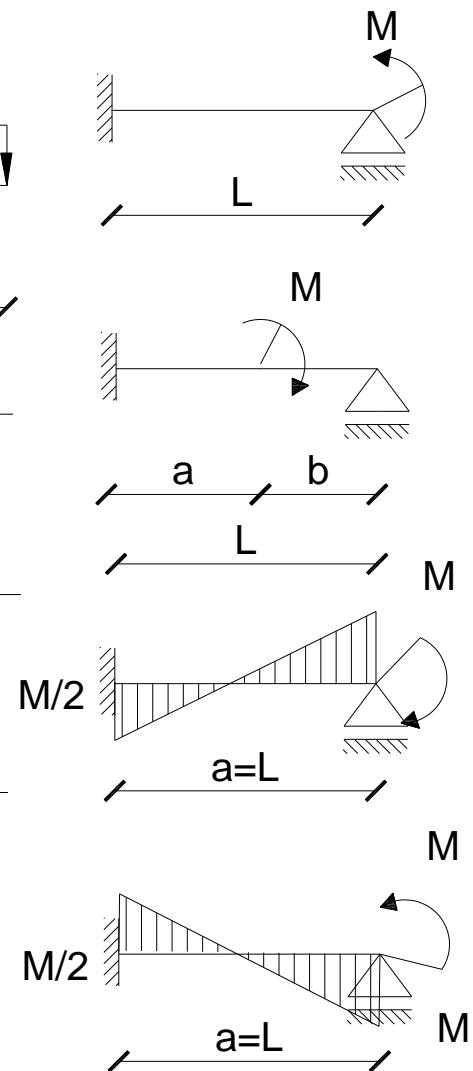
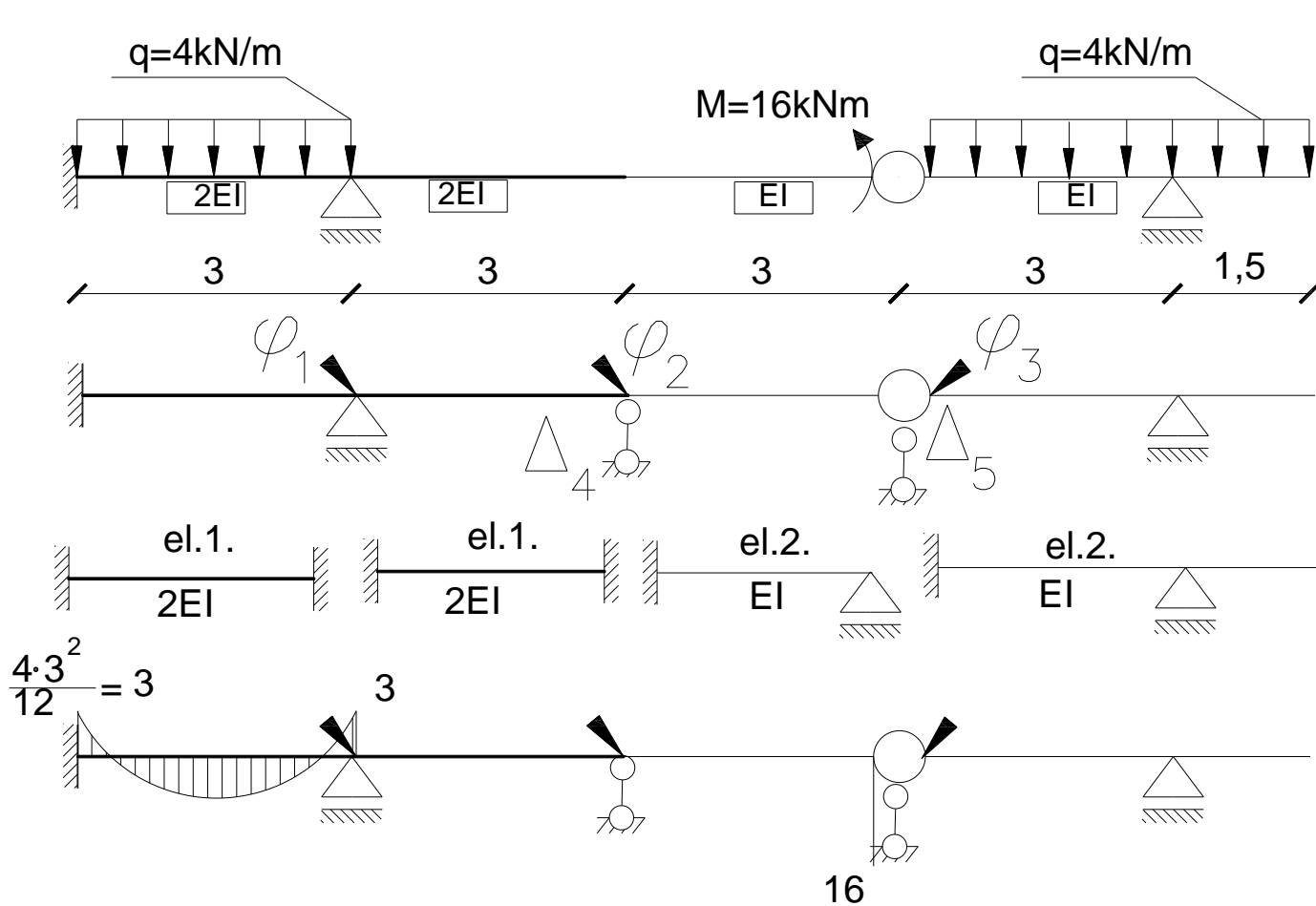

# Wykresy od obciążenia zewnętrznego

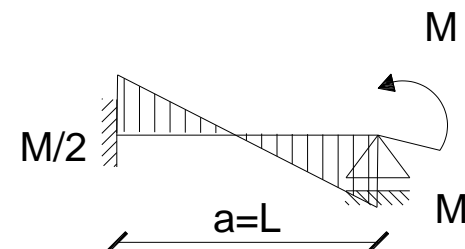
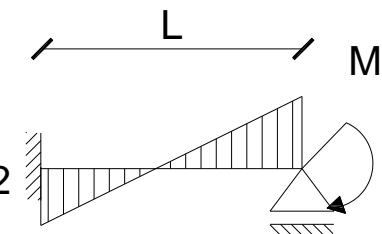
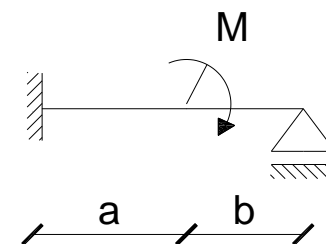
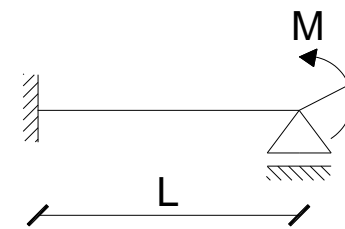
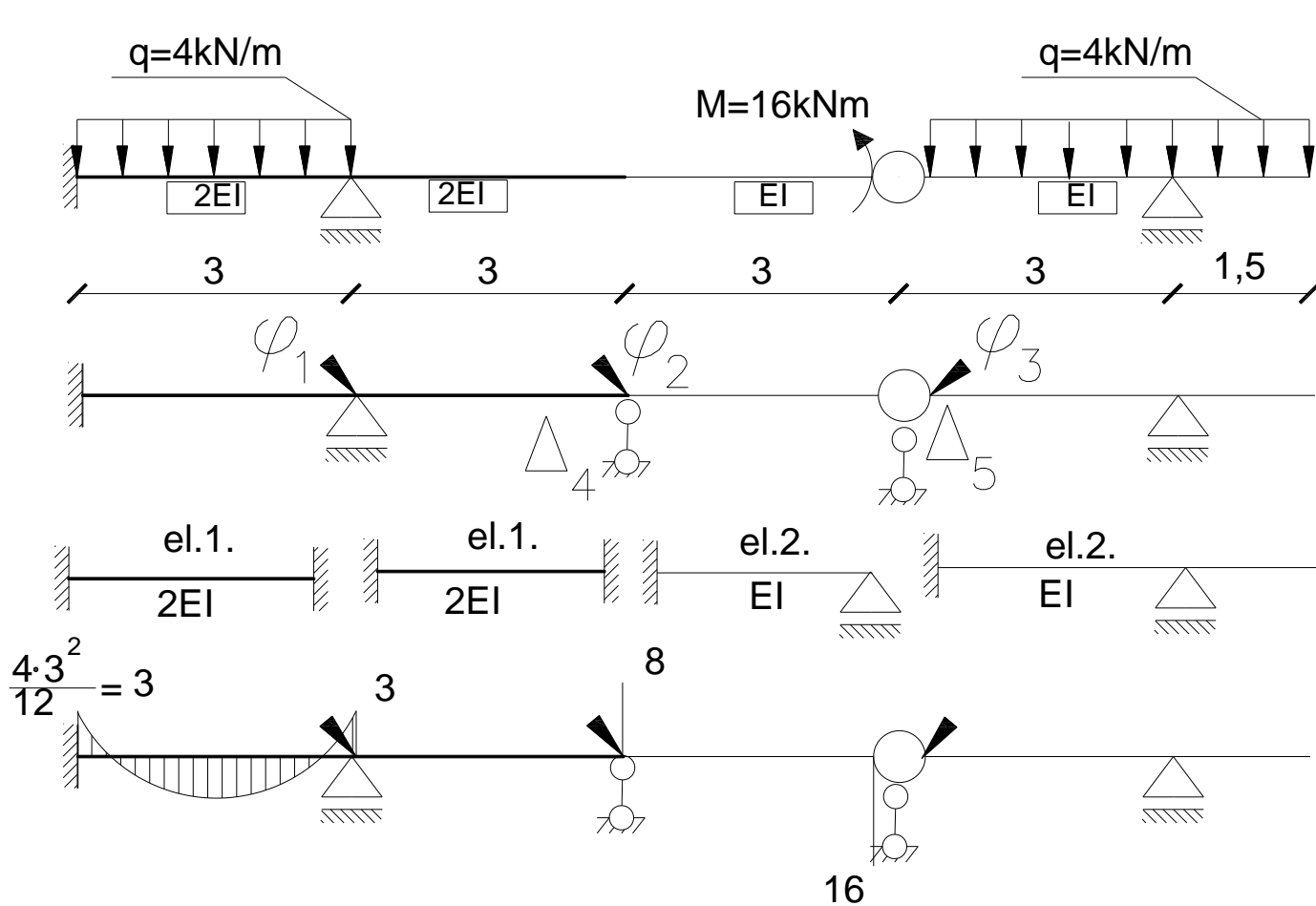

# Wykresy od obciążenia zewnętrznego

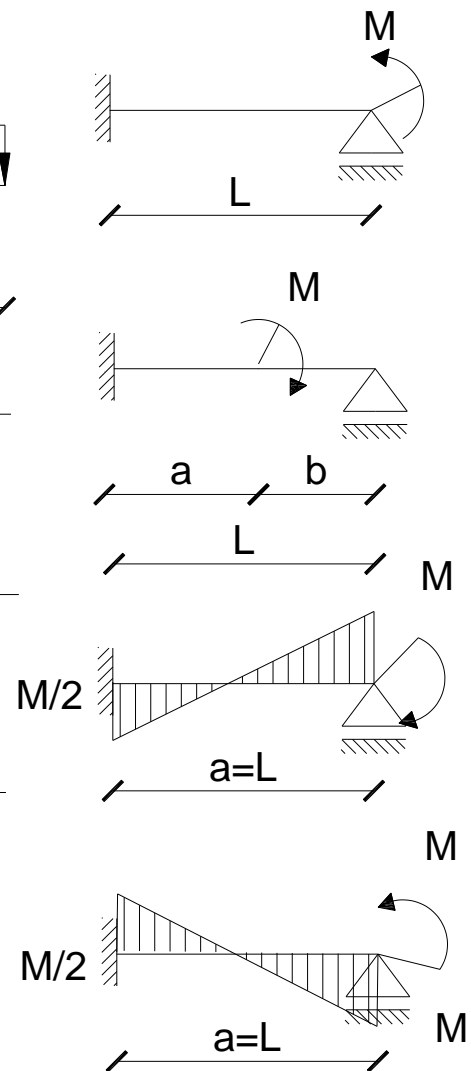
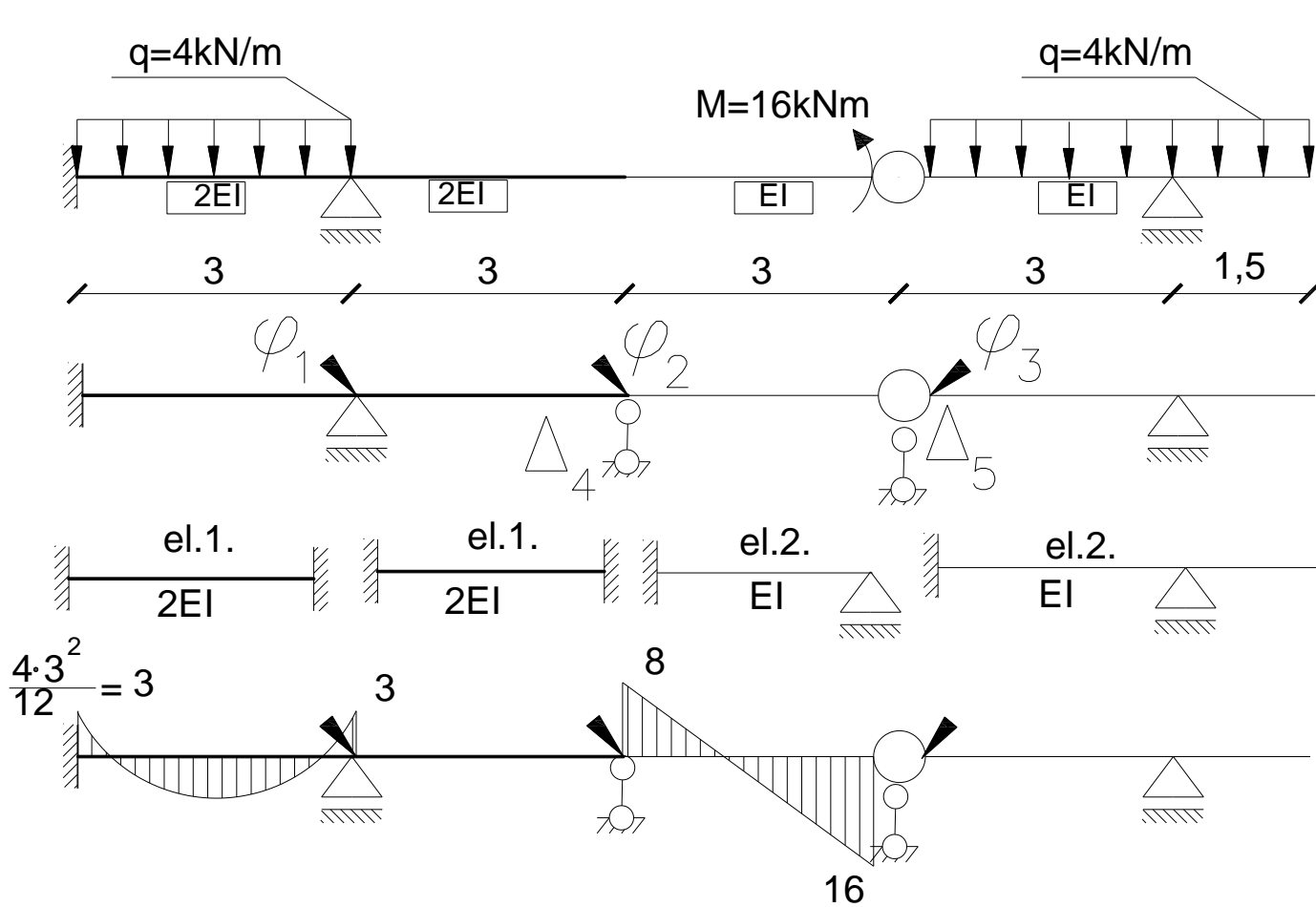

# Wykresy od obciążenia zewnętrznego

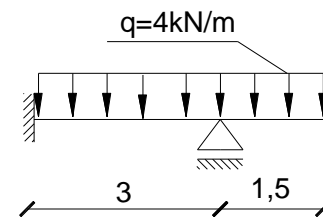
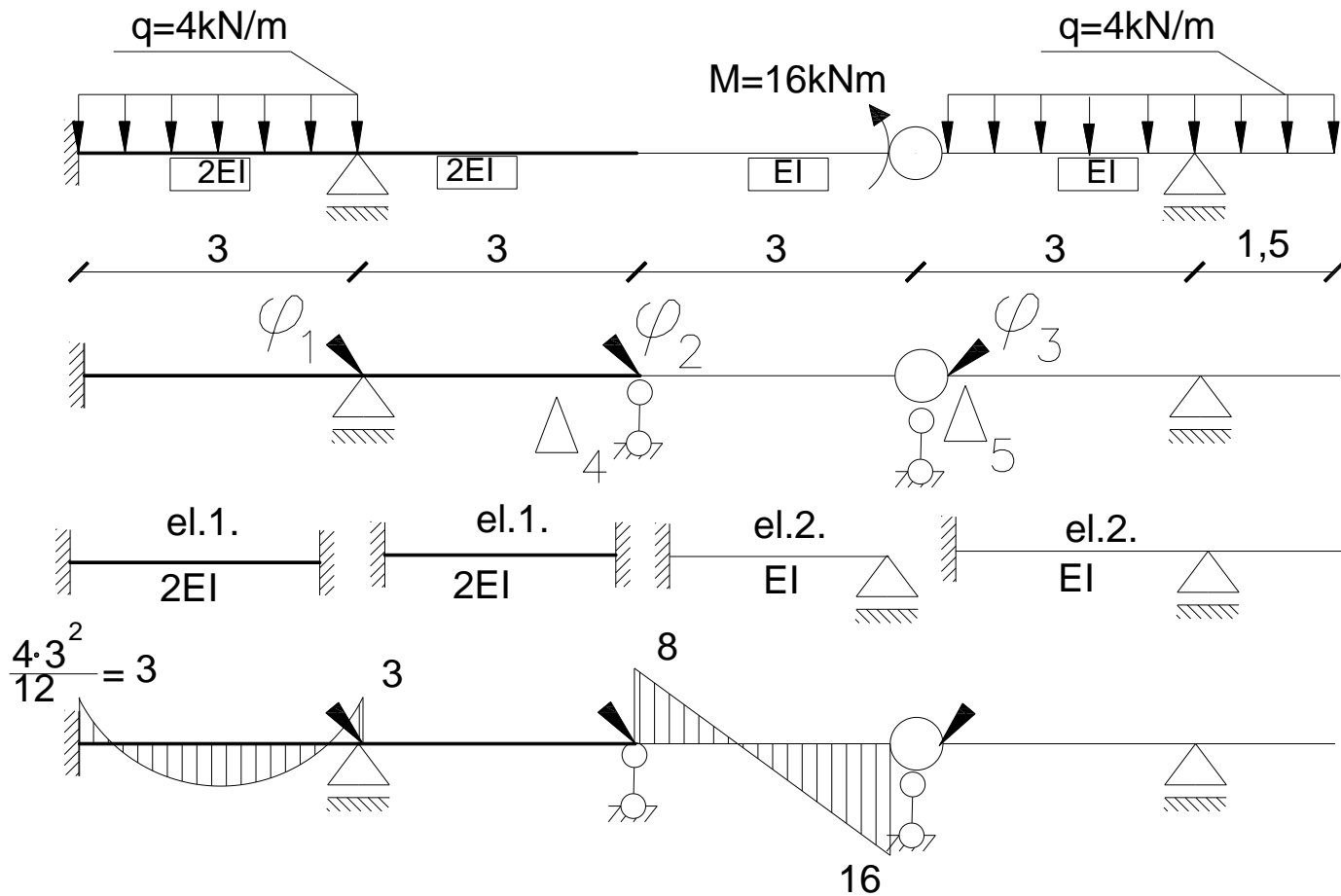

# Wykresy od obciążenia zewnętrznego

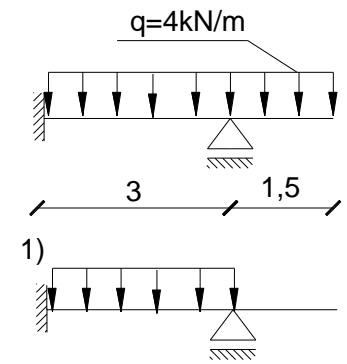
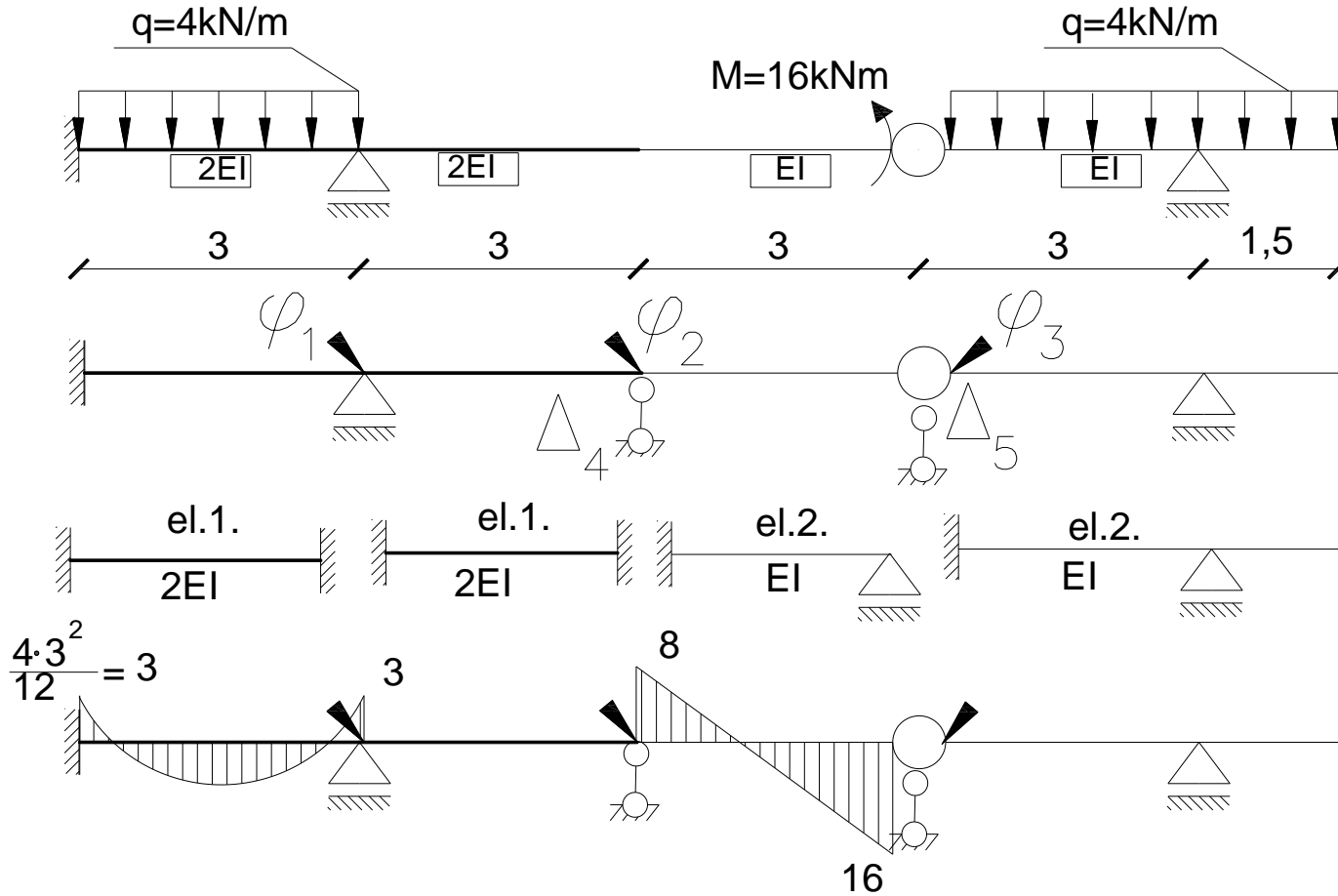

# Wykresy od obciążenia zewnętrznego

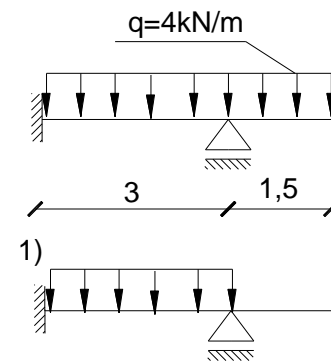
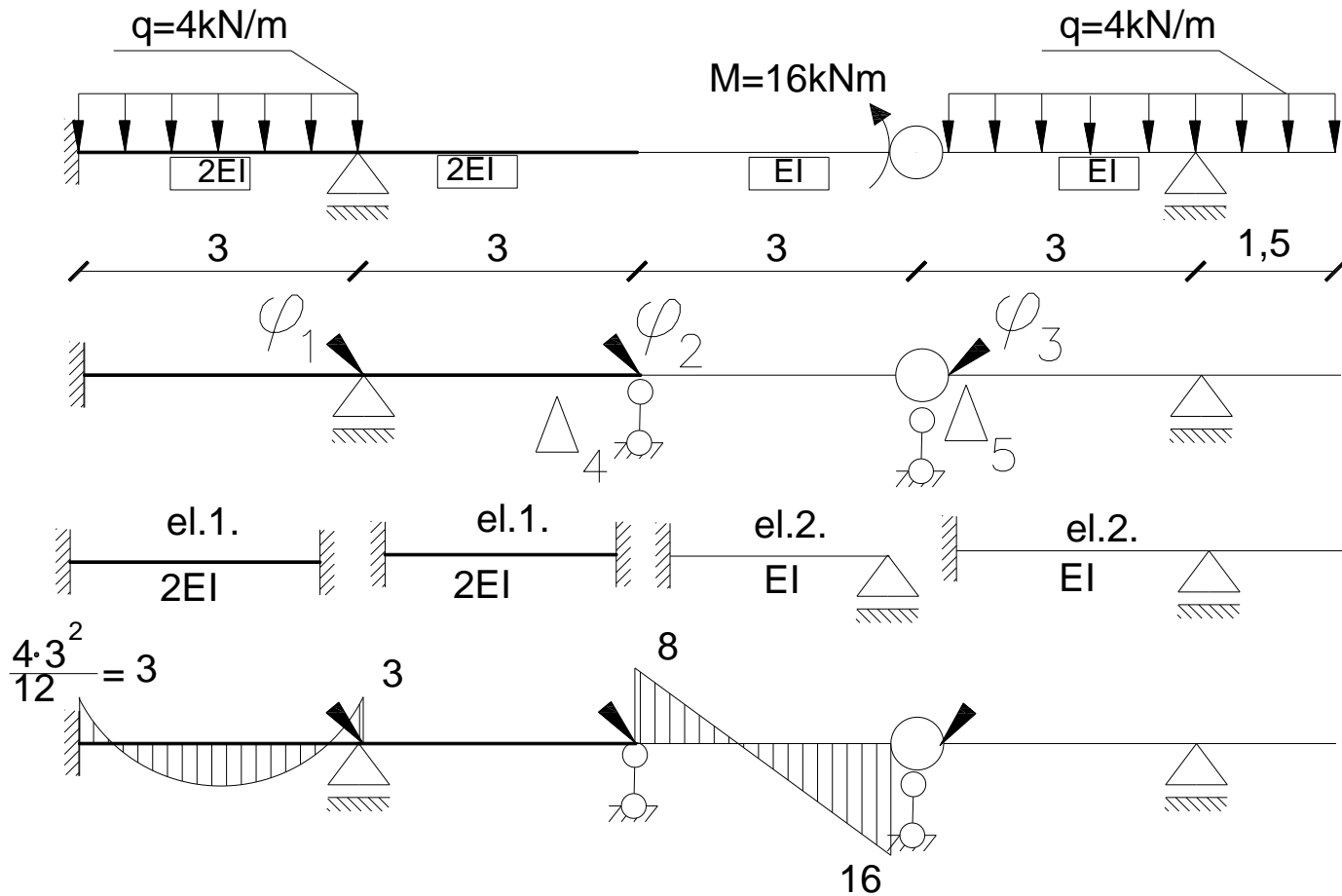

c. d. tablicy 14.1.

1	2	3
27		$-\frac{ql^2}{8}$

# Wykresy od obciążenia zewnętrznego

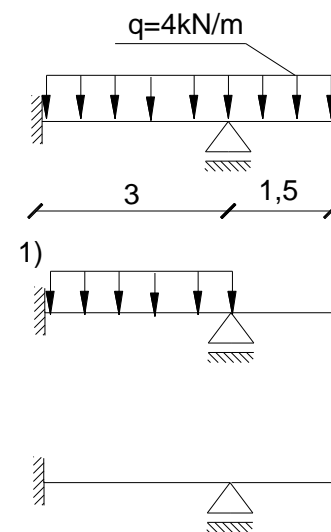
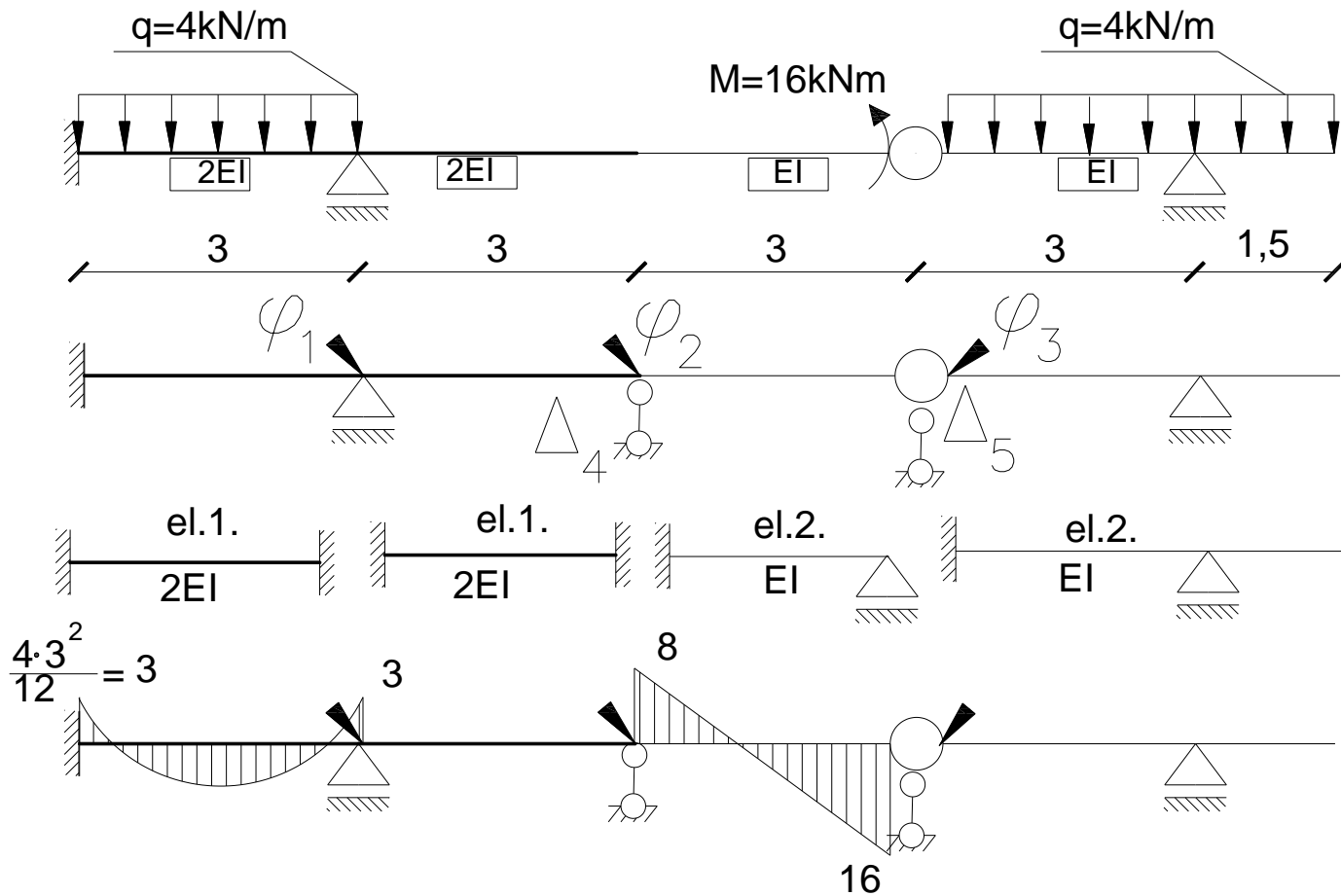

c. d. tablicy 14.1.

1	2	3
27		$-\frac{ql^2}{8}$

# Wykresy od obciążenia zewnętrznego

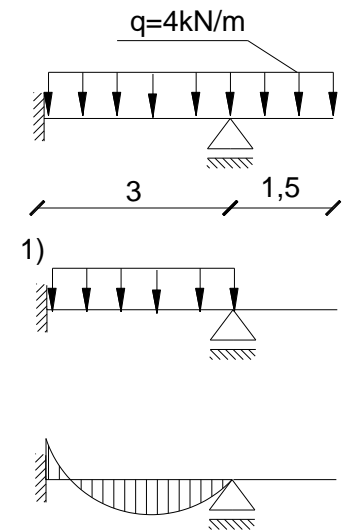
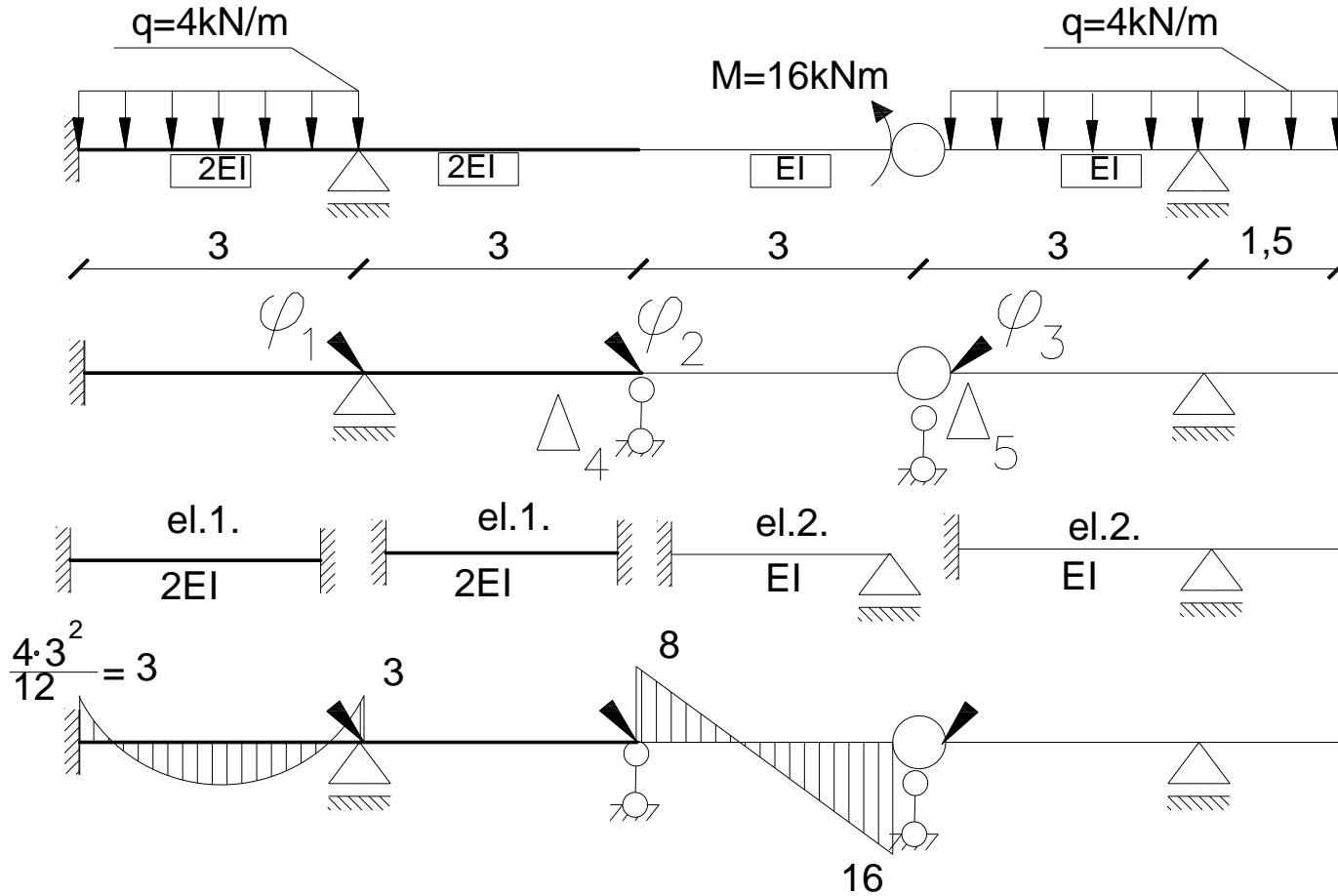

c. d. tablicy 14.1.

1	2	3
27		$-\frac{ql^2}{8}$



# Wykresy od obciążenia zewnętrznego

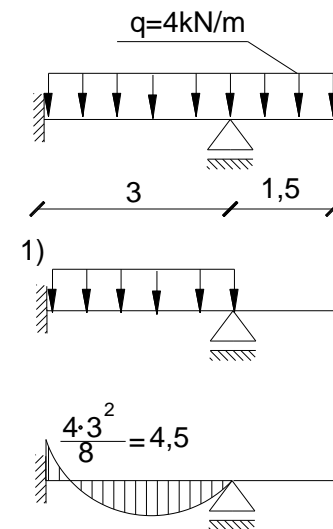
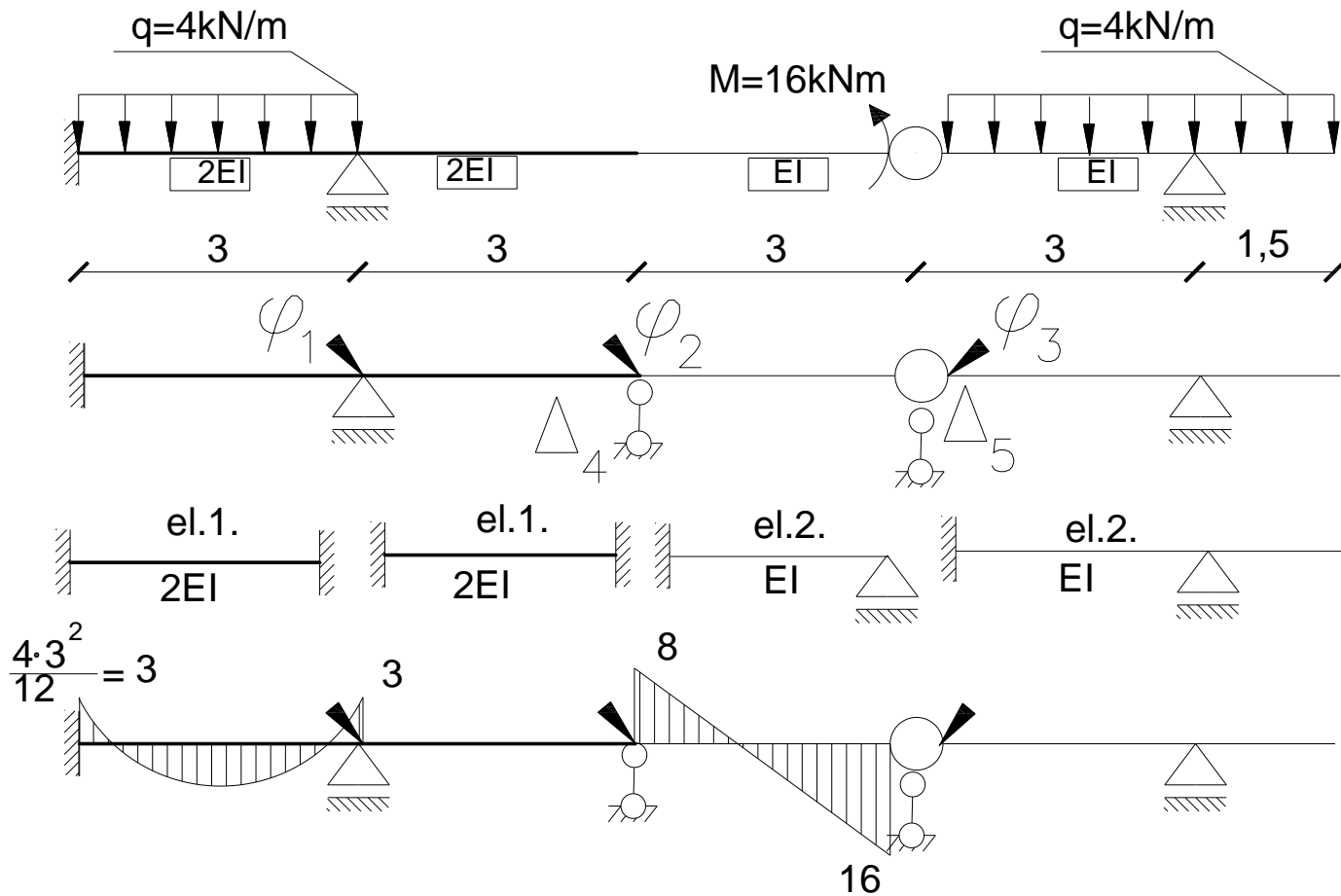

c. d. tablicy 14.1.

1	2	3
27		$-\frac{ql^2}{8}$

# Wykresy od obciążenia zewnętrznego

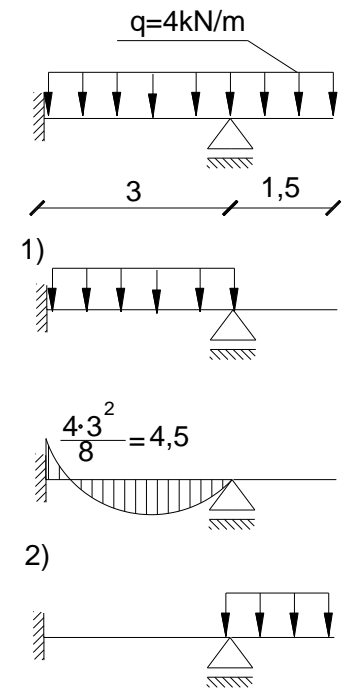
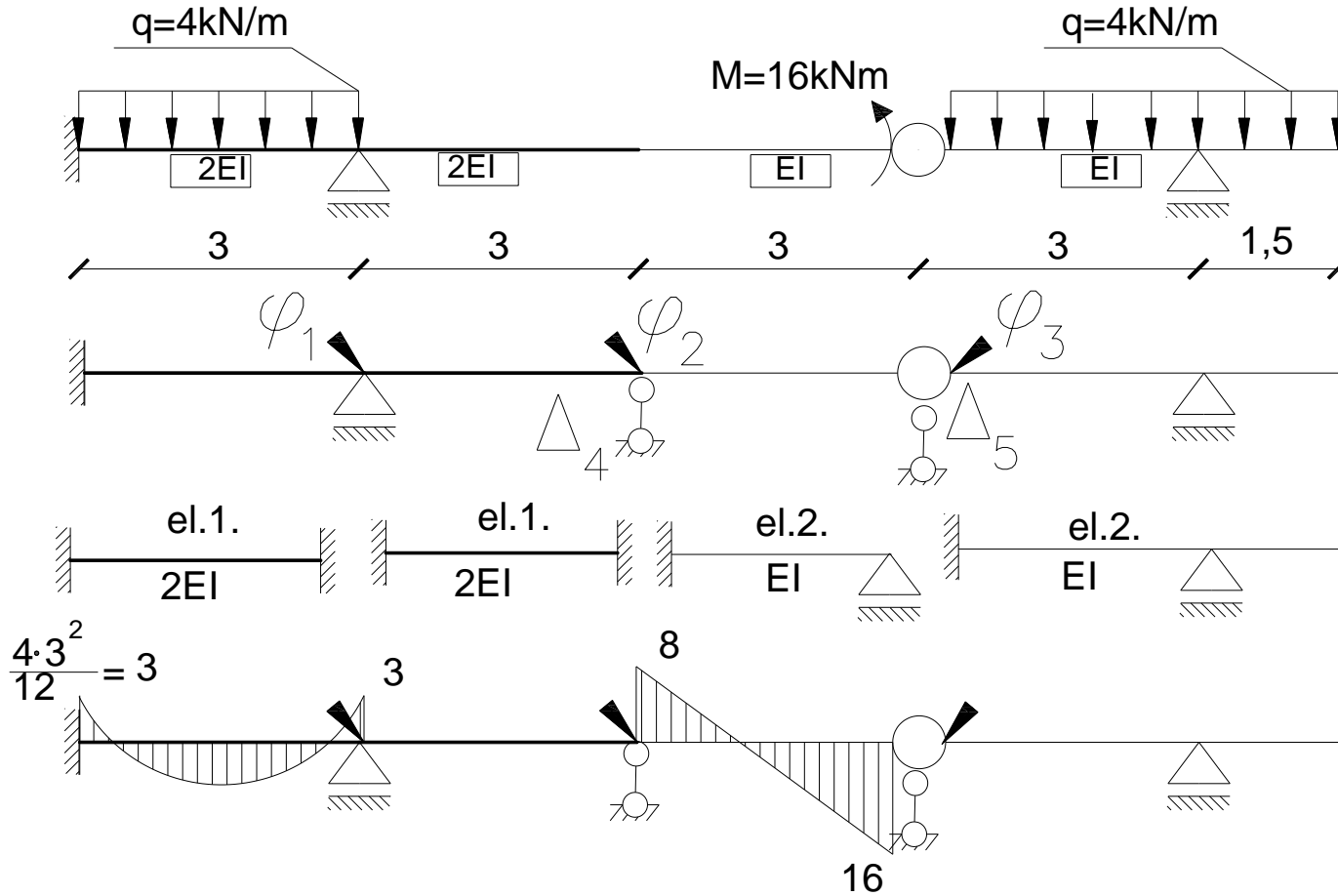

# Wykresy od obciążenia zewnętrznego

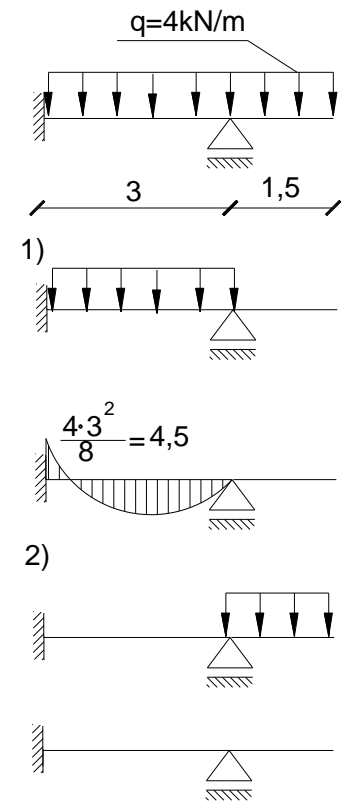
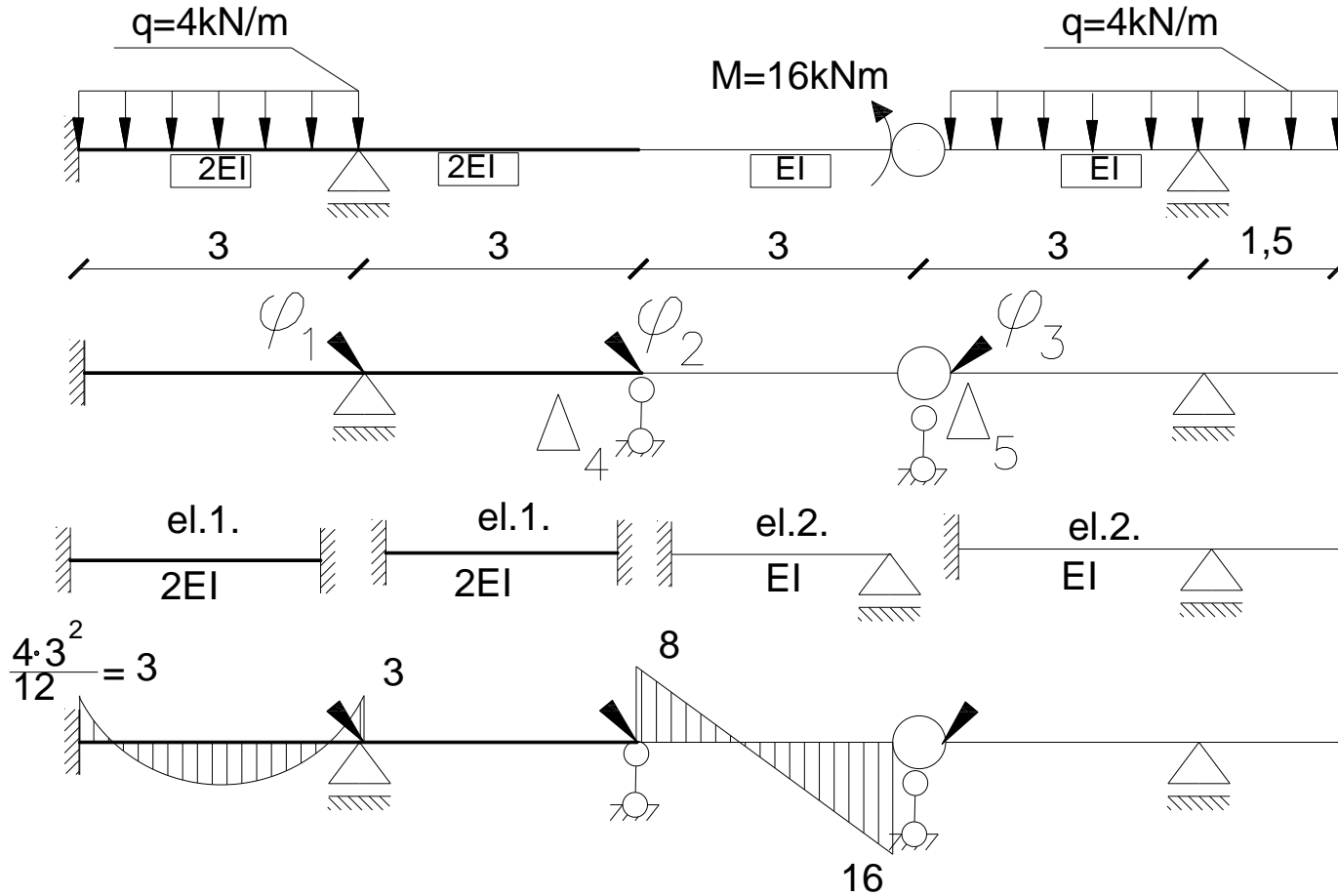

# Wykresy od obciążenia zewnętrznego

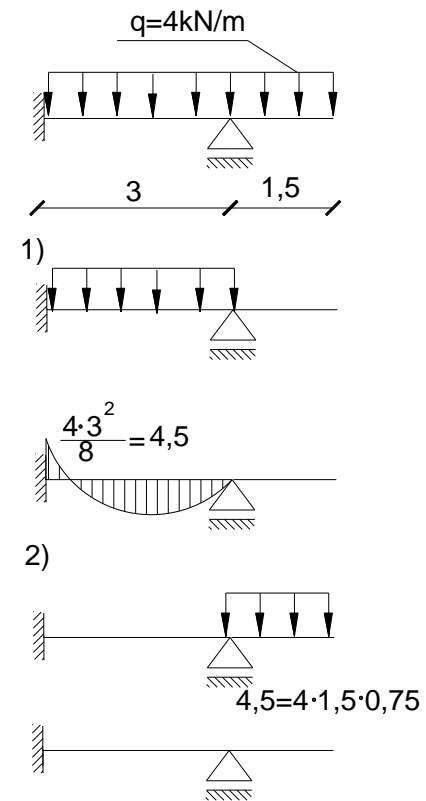
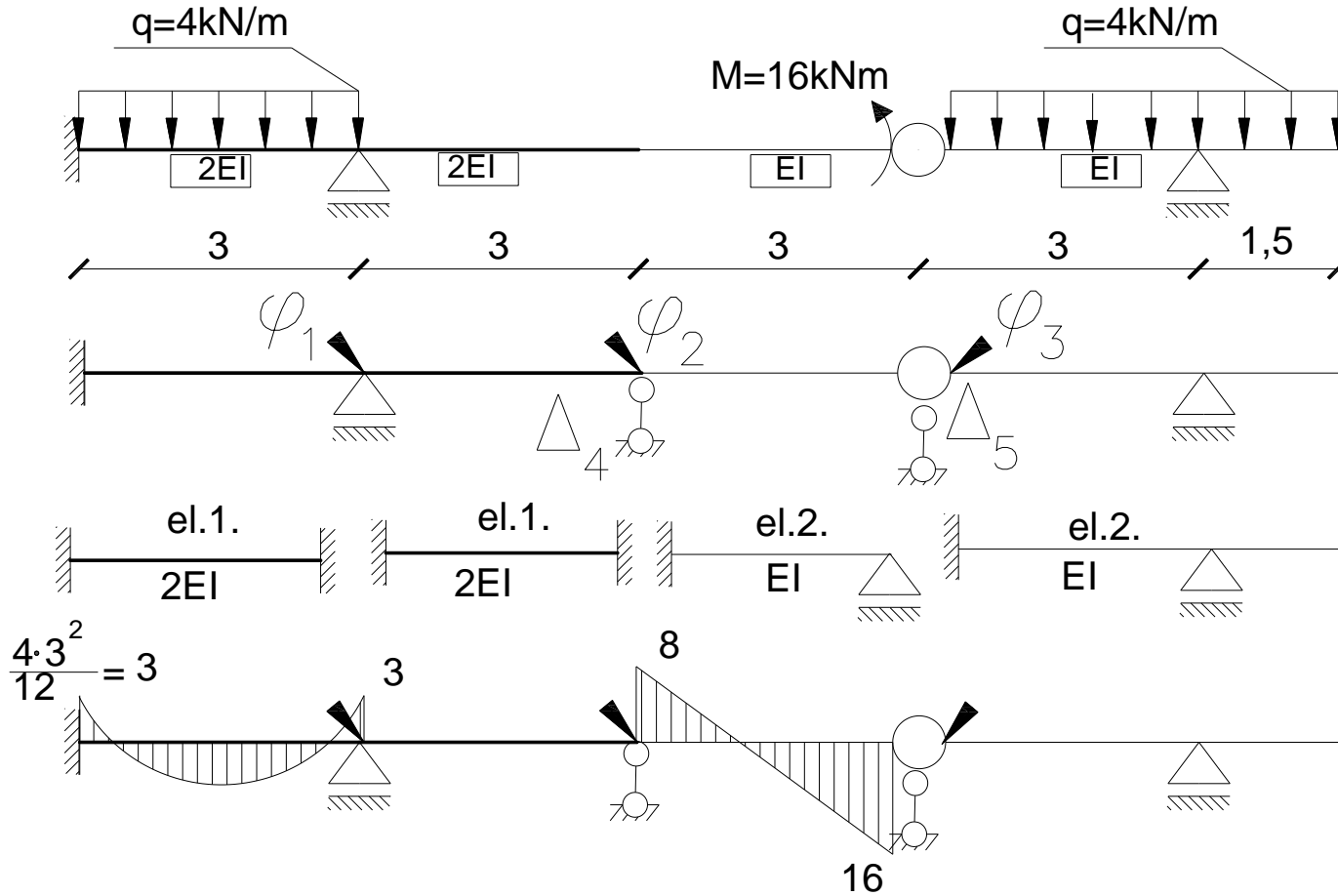

# Wykresy od obciążenia zewnętrznego

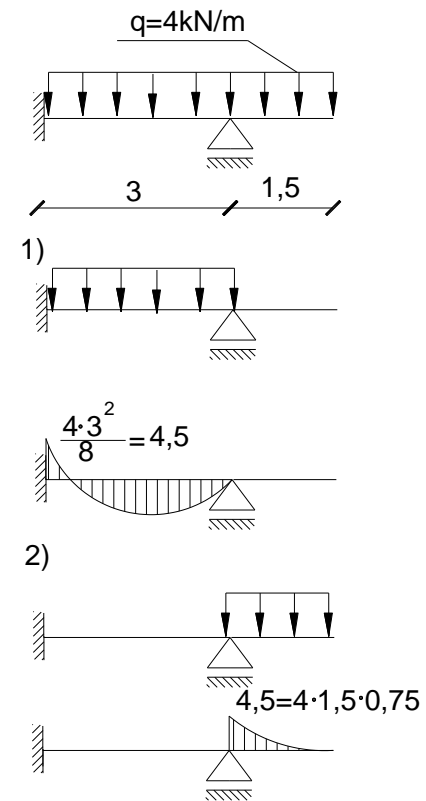
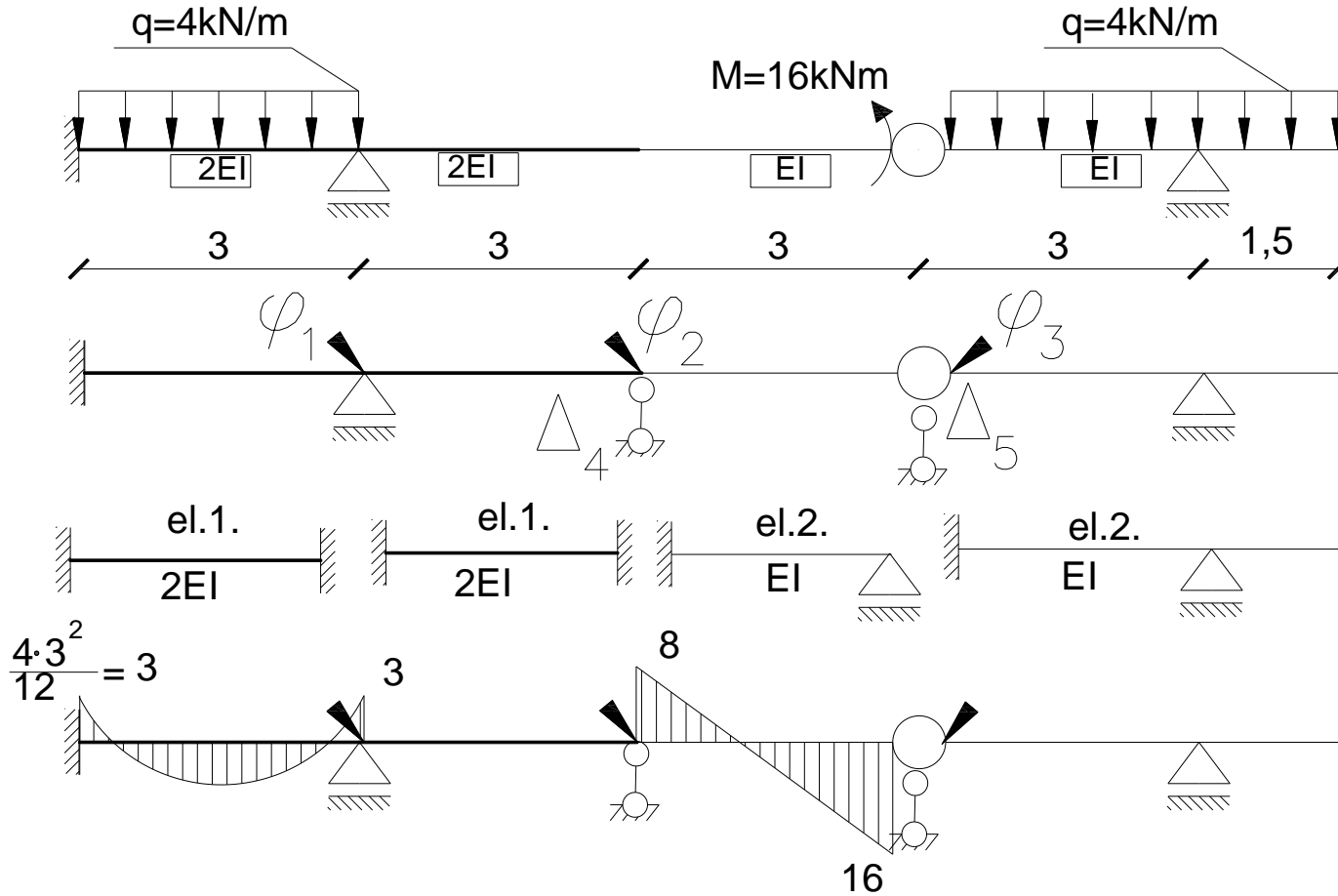

# Wykresy od obciążenia zewnętrznego

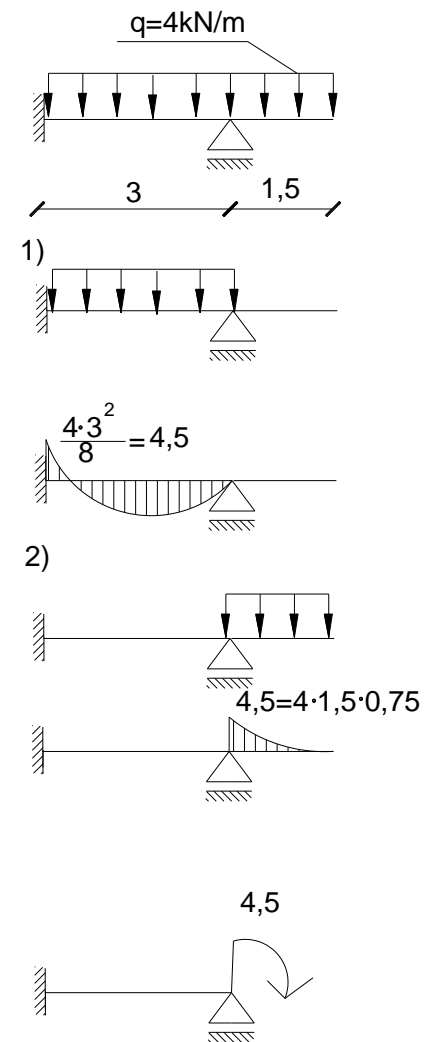
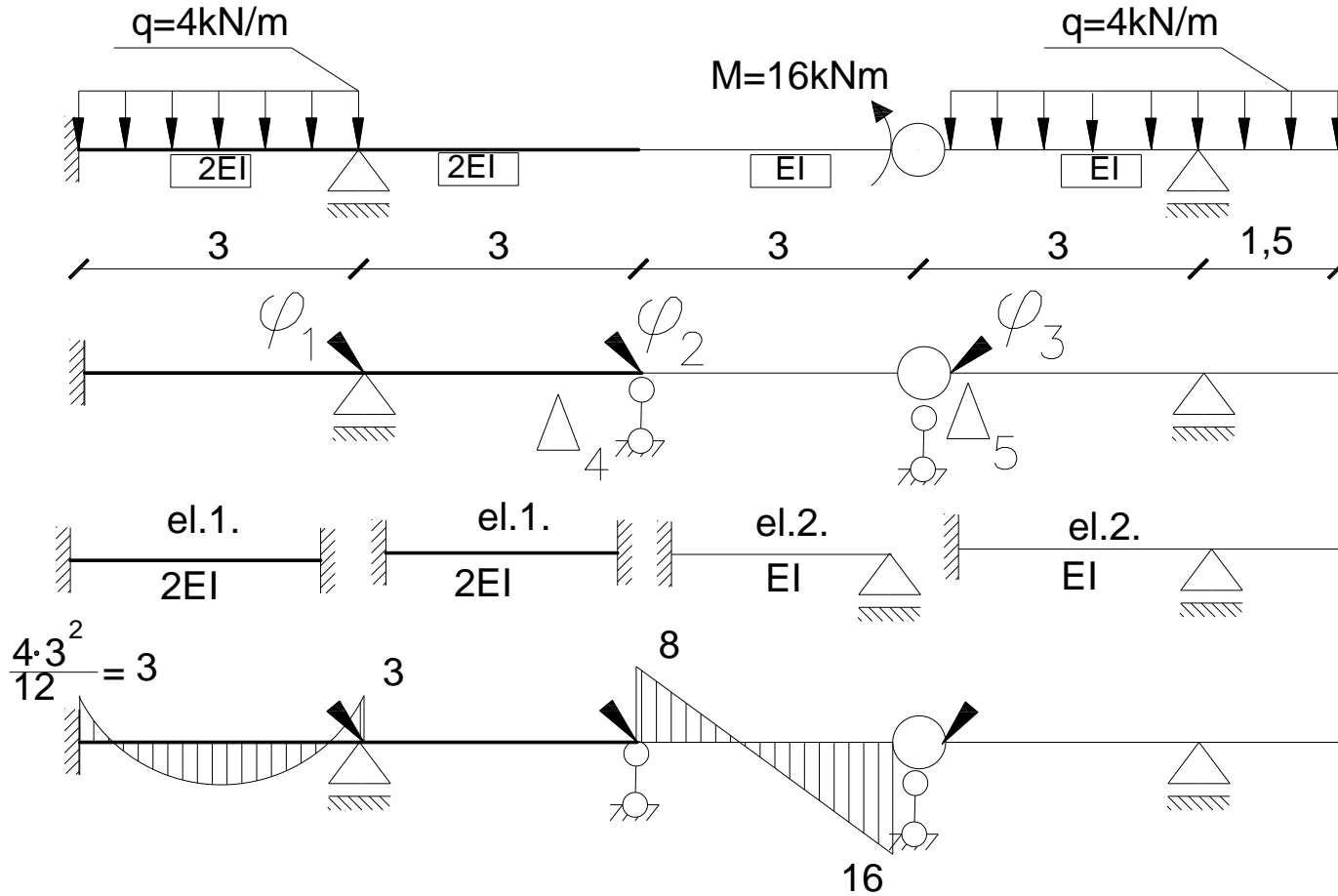

# Wykresy od obciążenia zewnętrznego

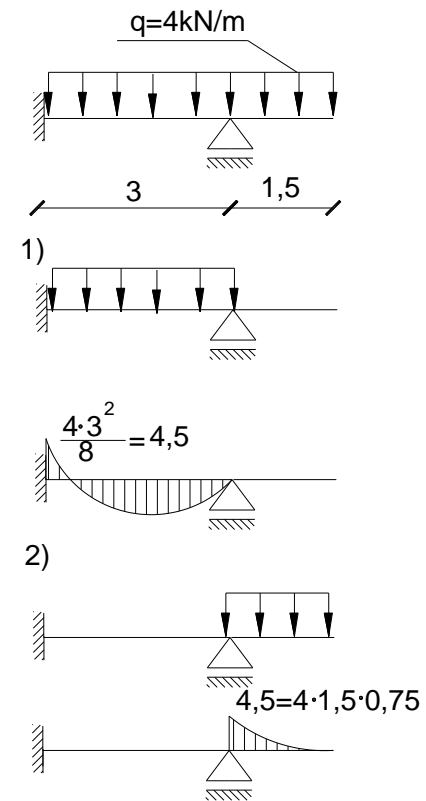
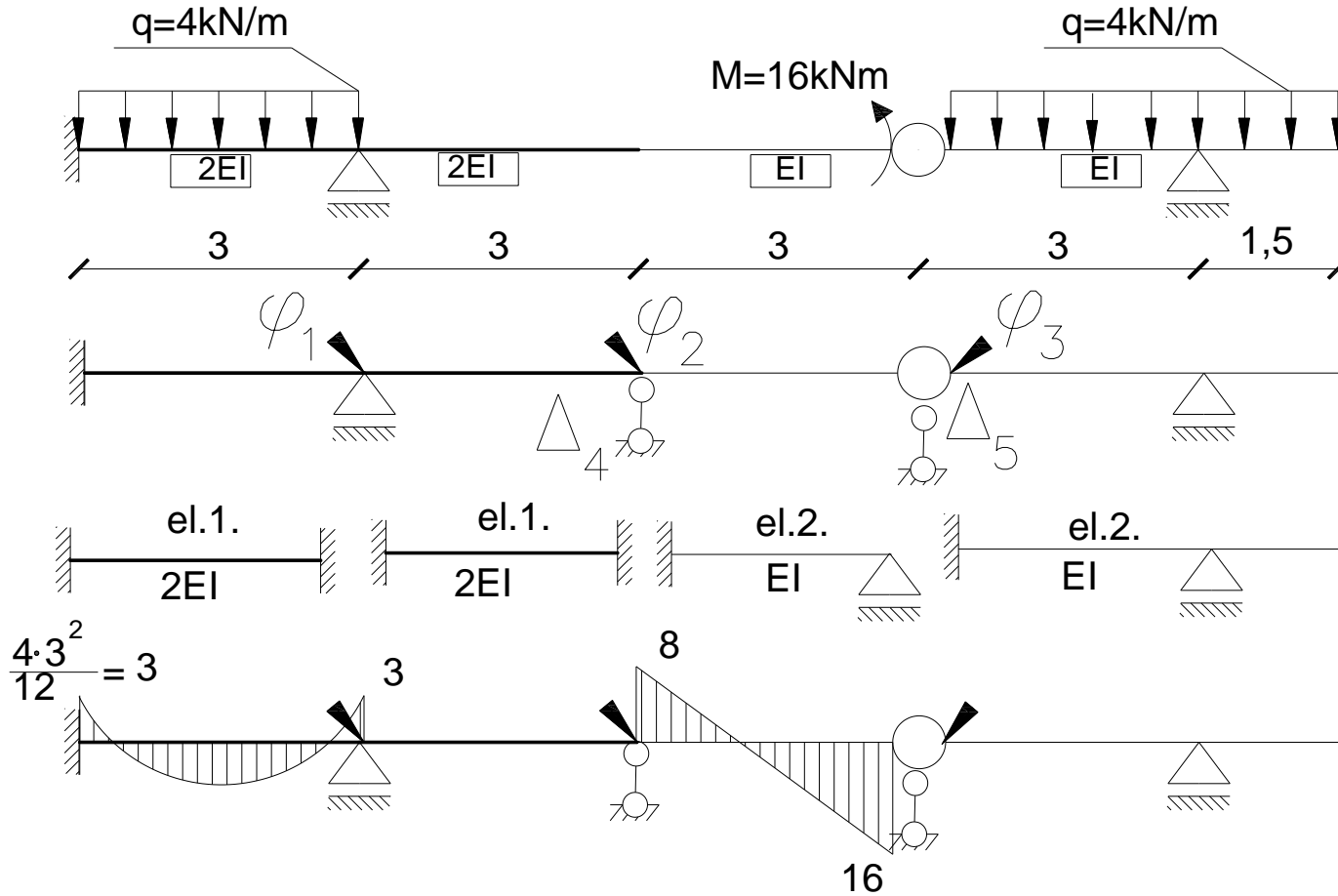

# Wykresy od obciążenia zewnętrznego

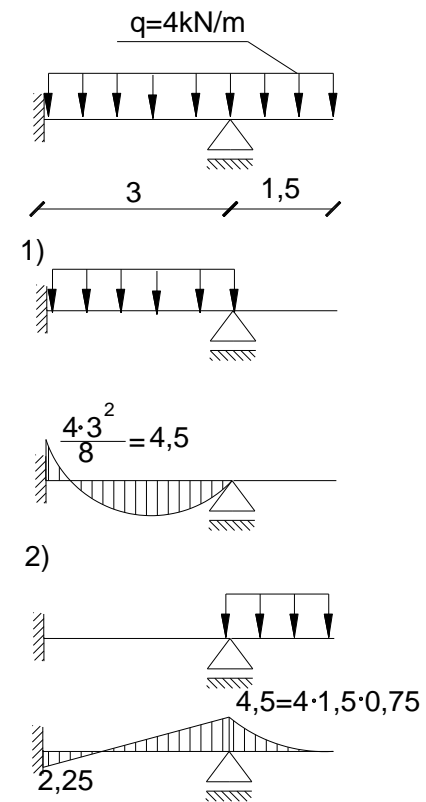
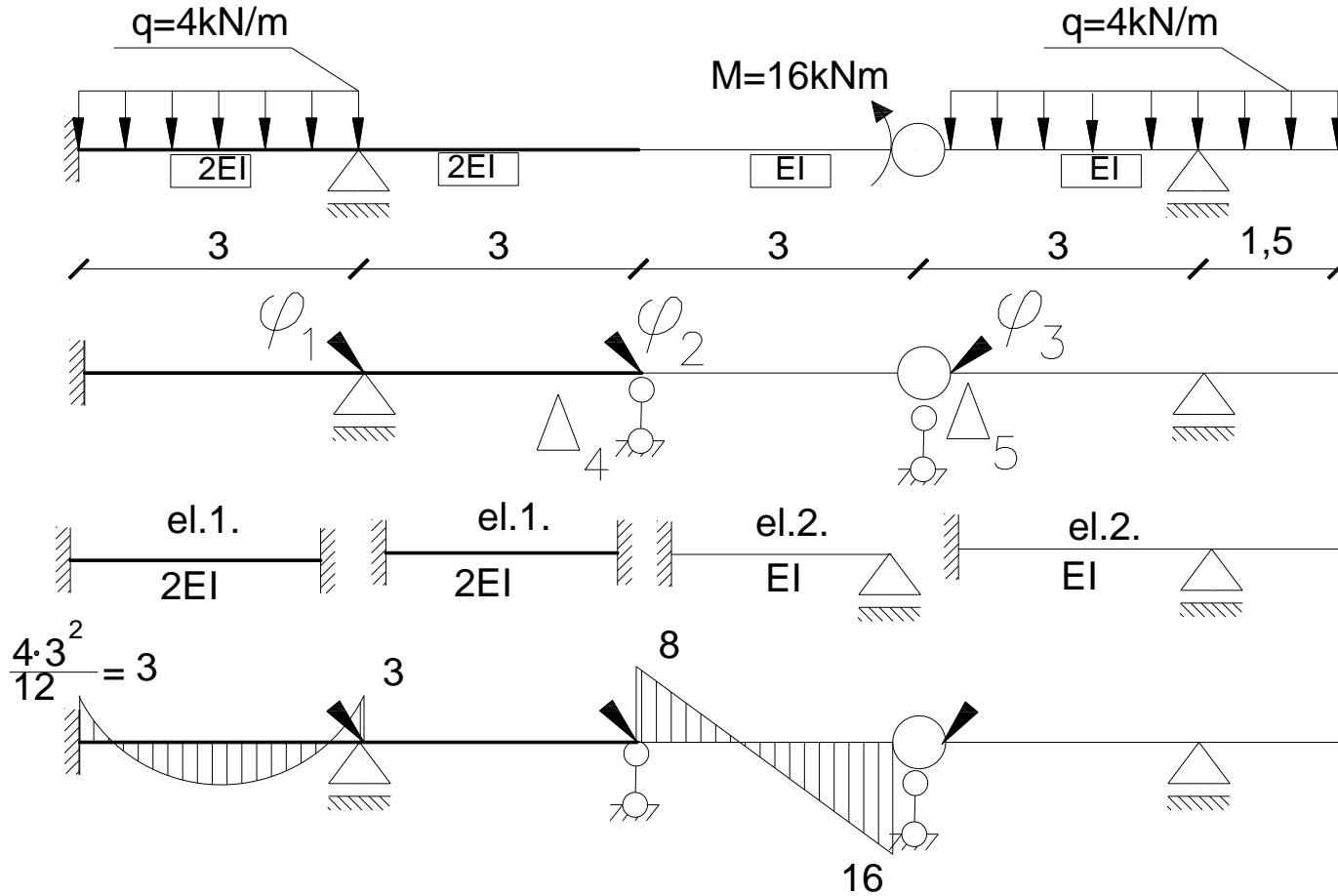



# Wykresy od obciążenia zewnętrznego

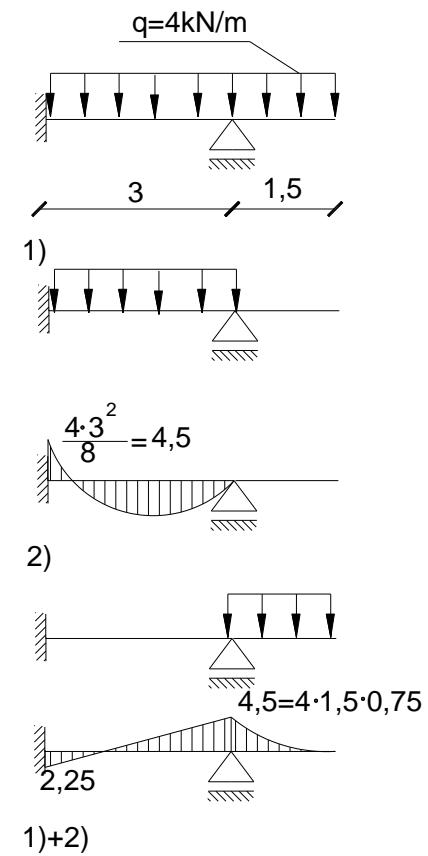
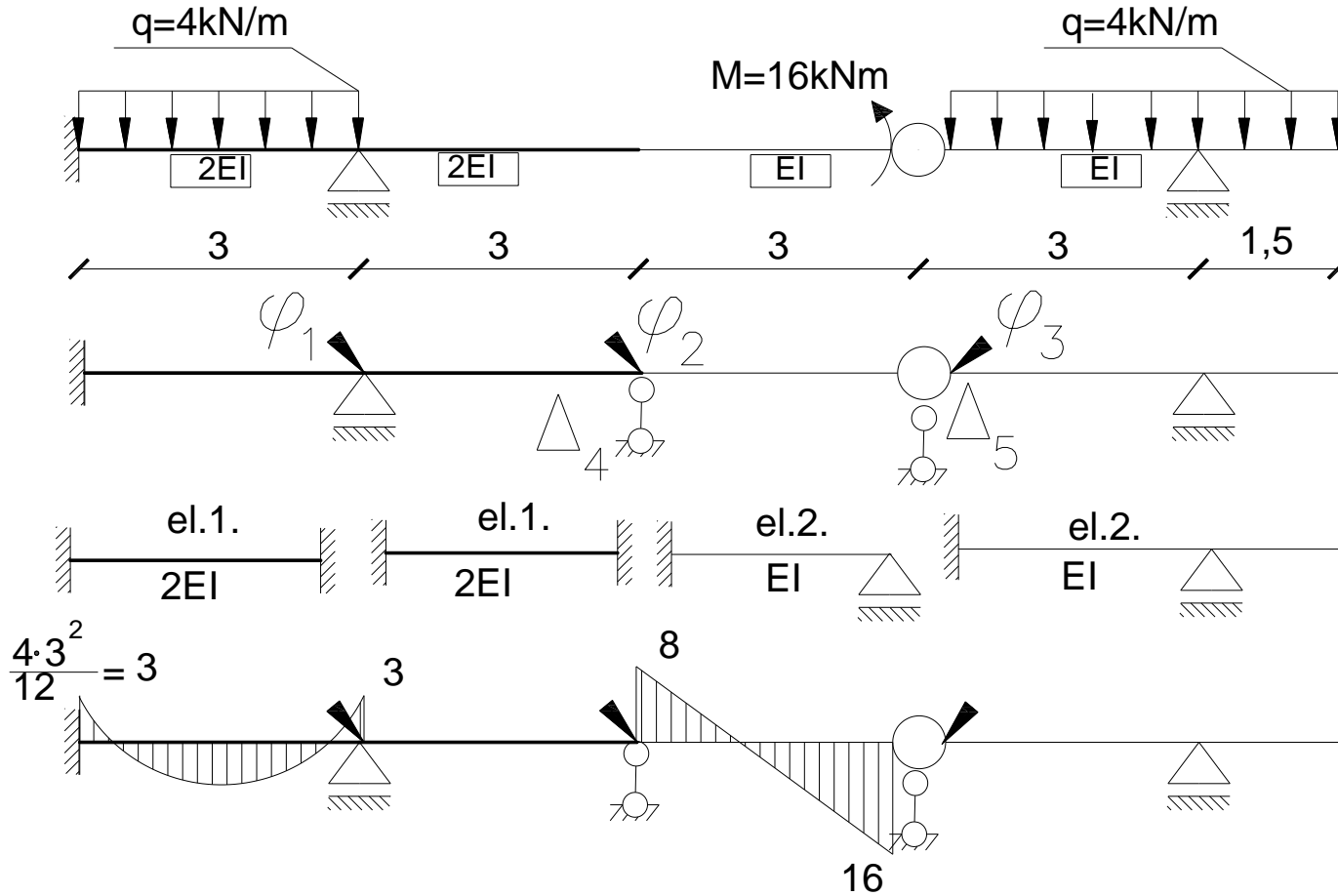

# Wykresy od obciążenia zewnętrznego

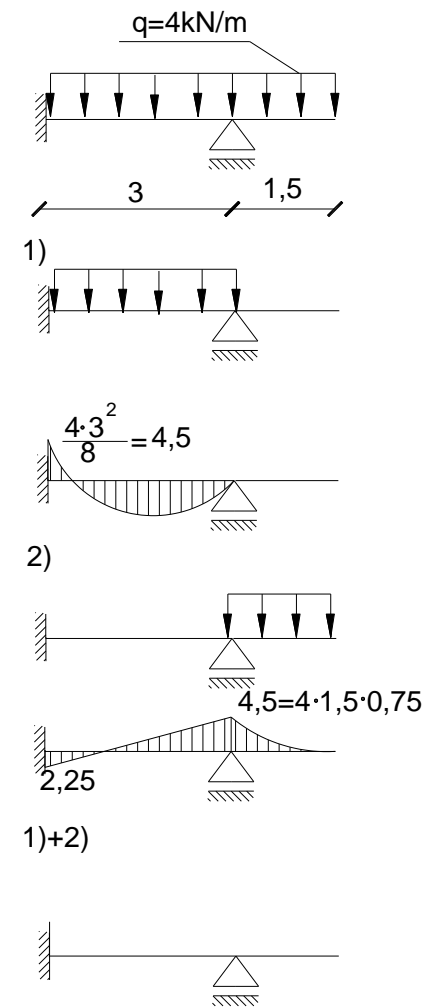
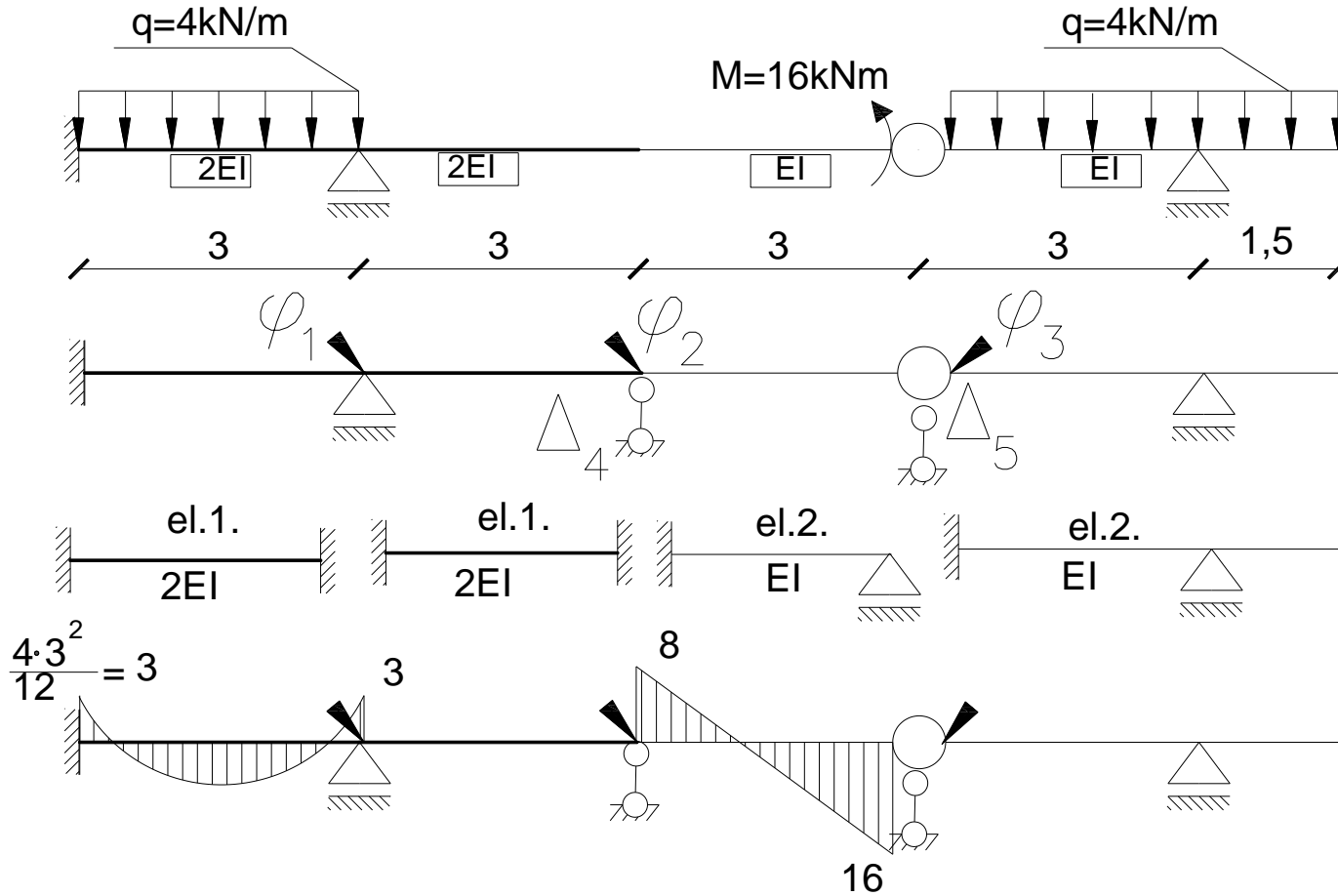

# Wykresy od obciążenia zewnętrznego

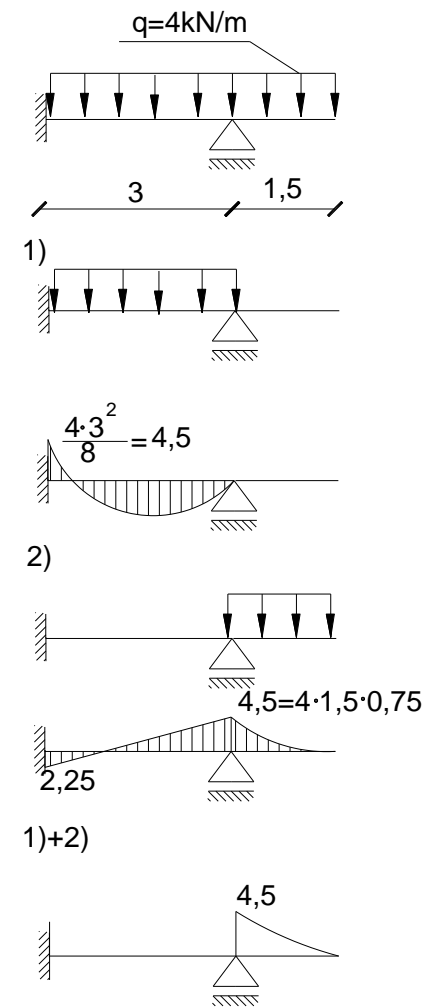
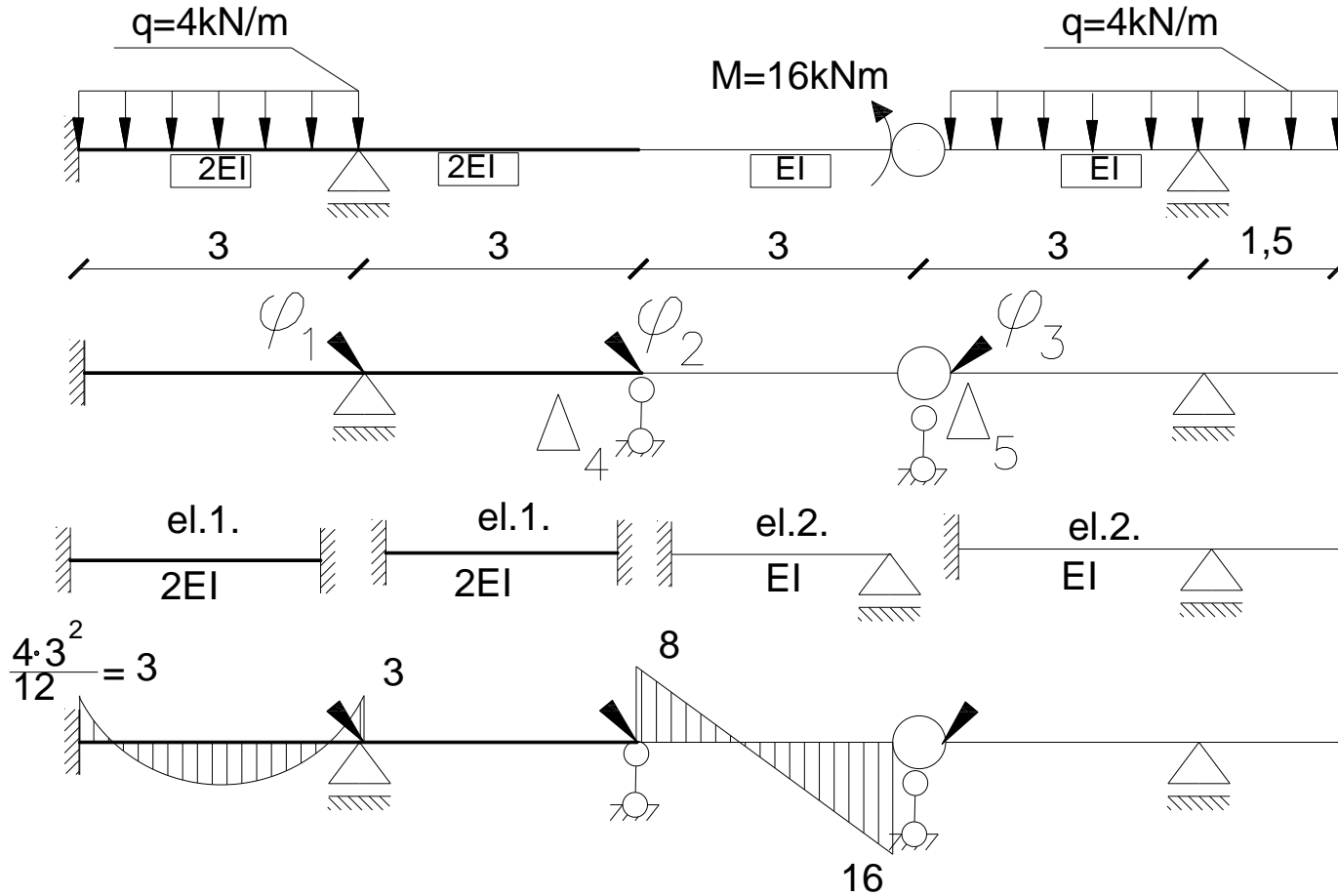

# Wykresy od obciążenia zewnętrznego

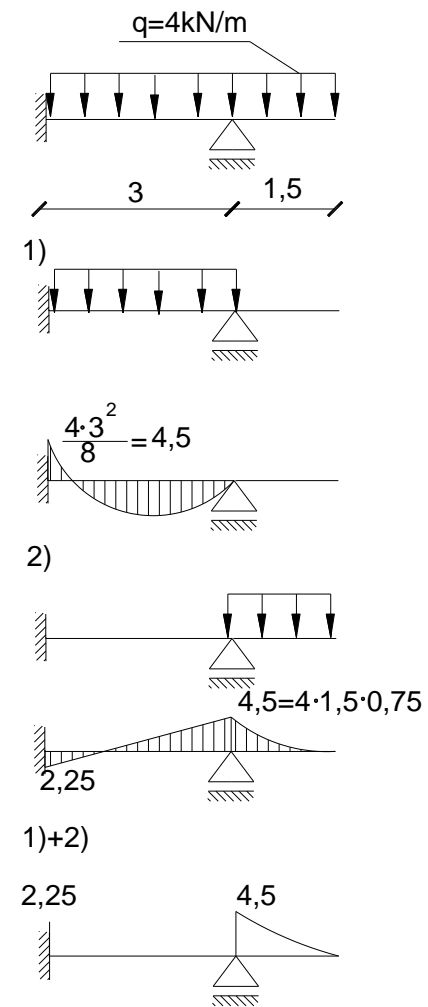
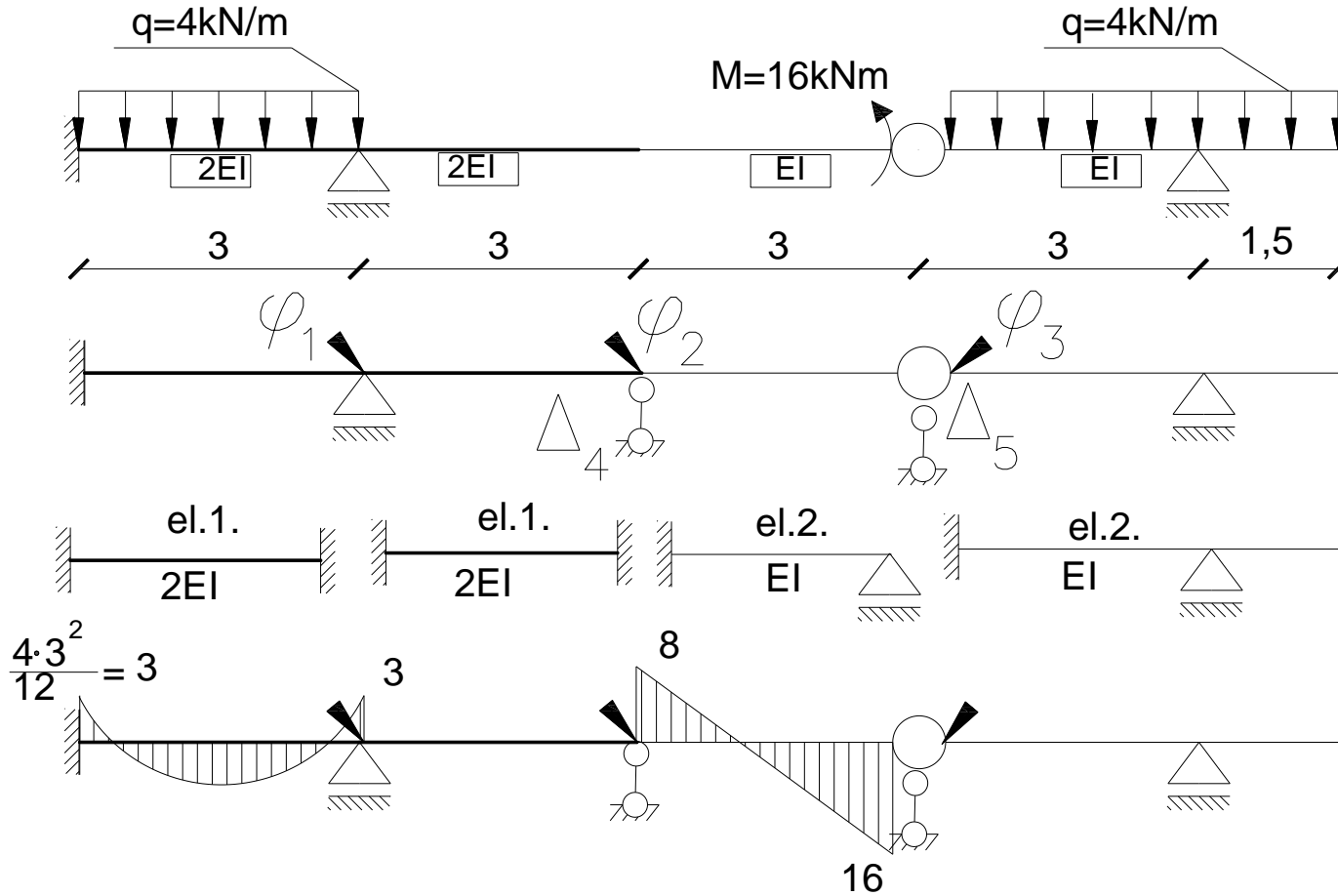

# Wykresy od obciążenia zewnętrznego

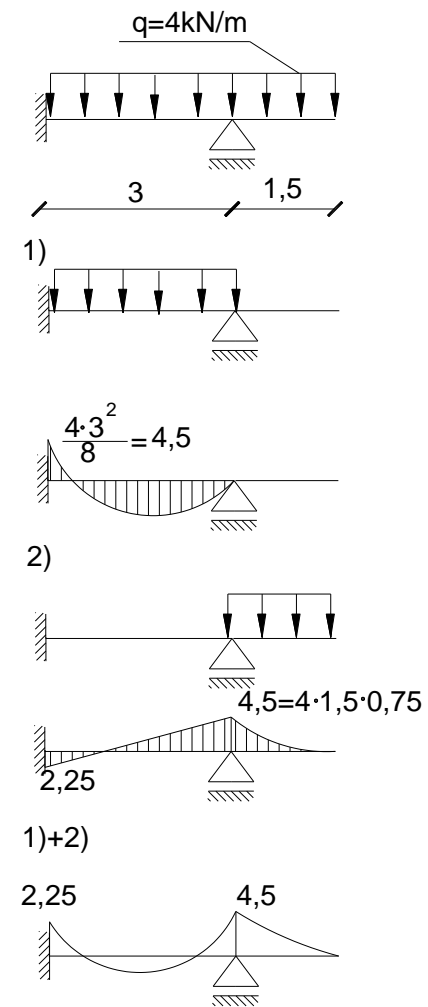
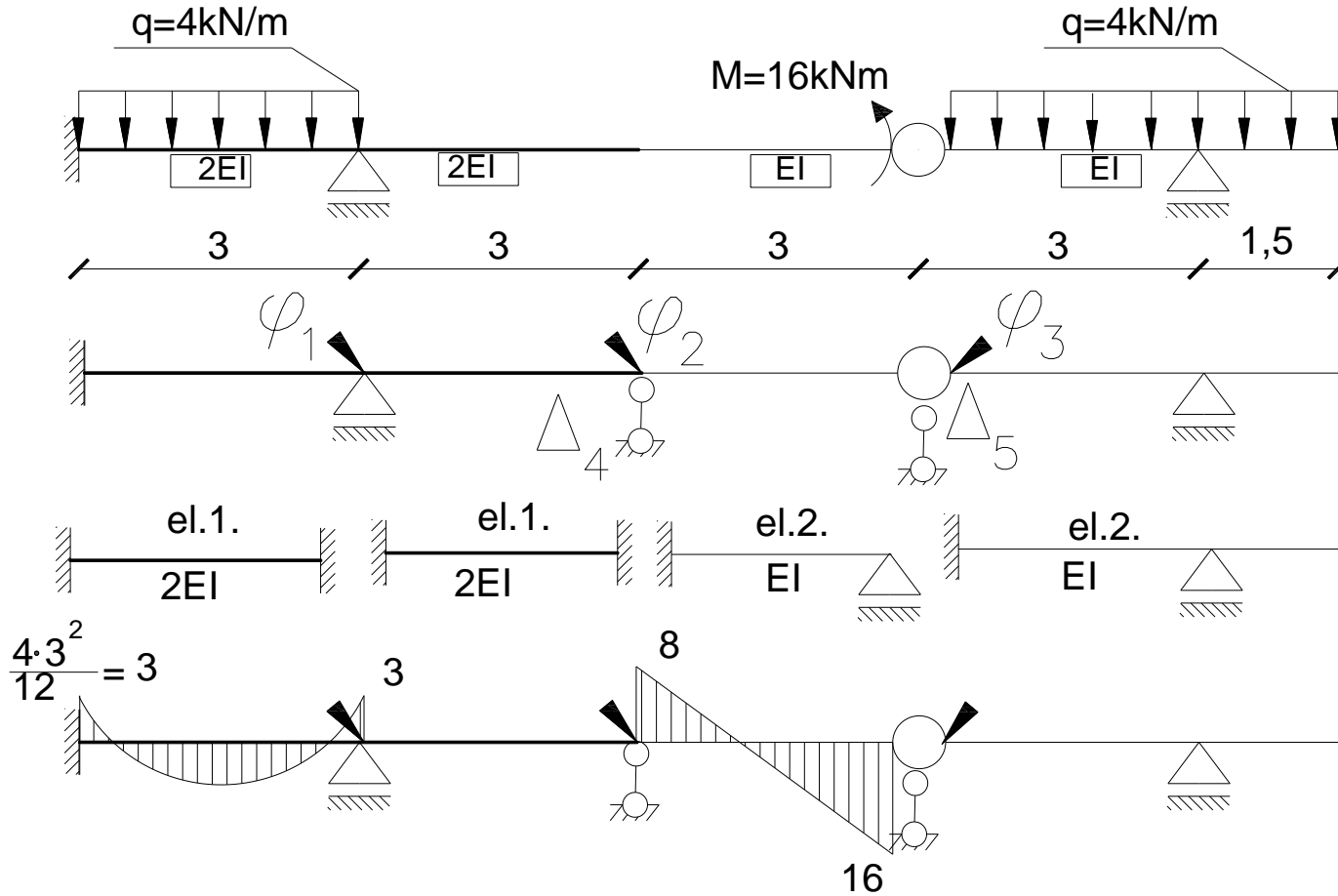

# Wykresy od obciążenia zewnętrznego

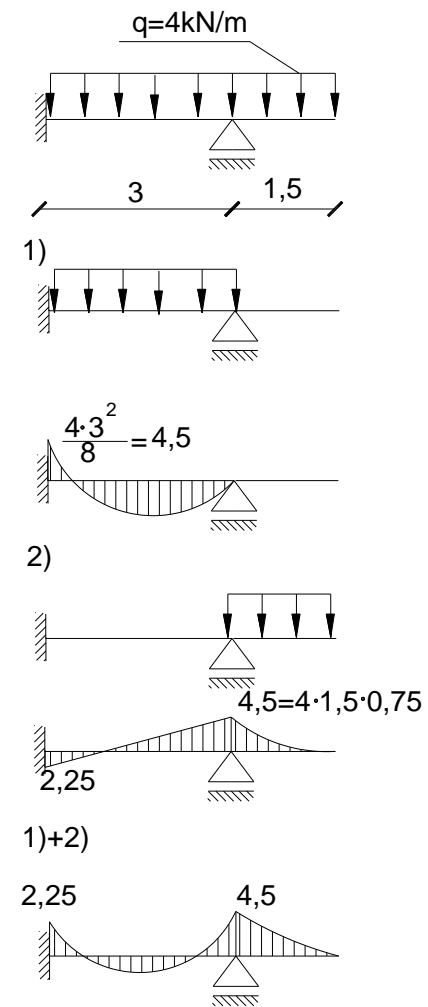
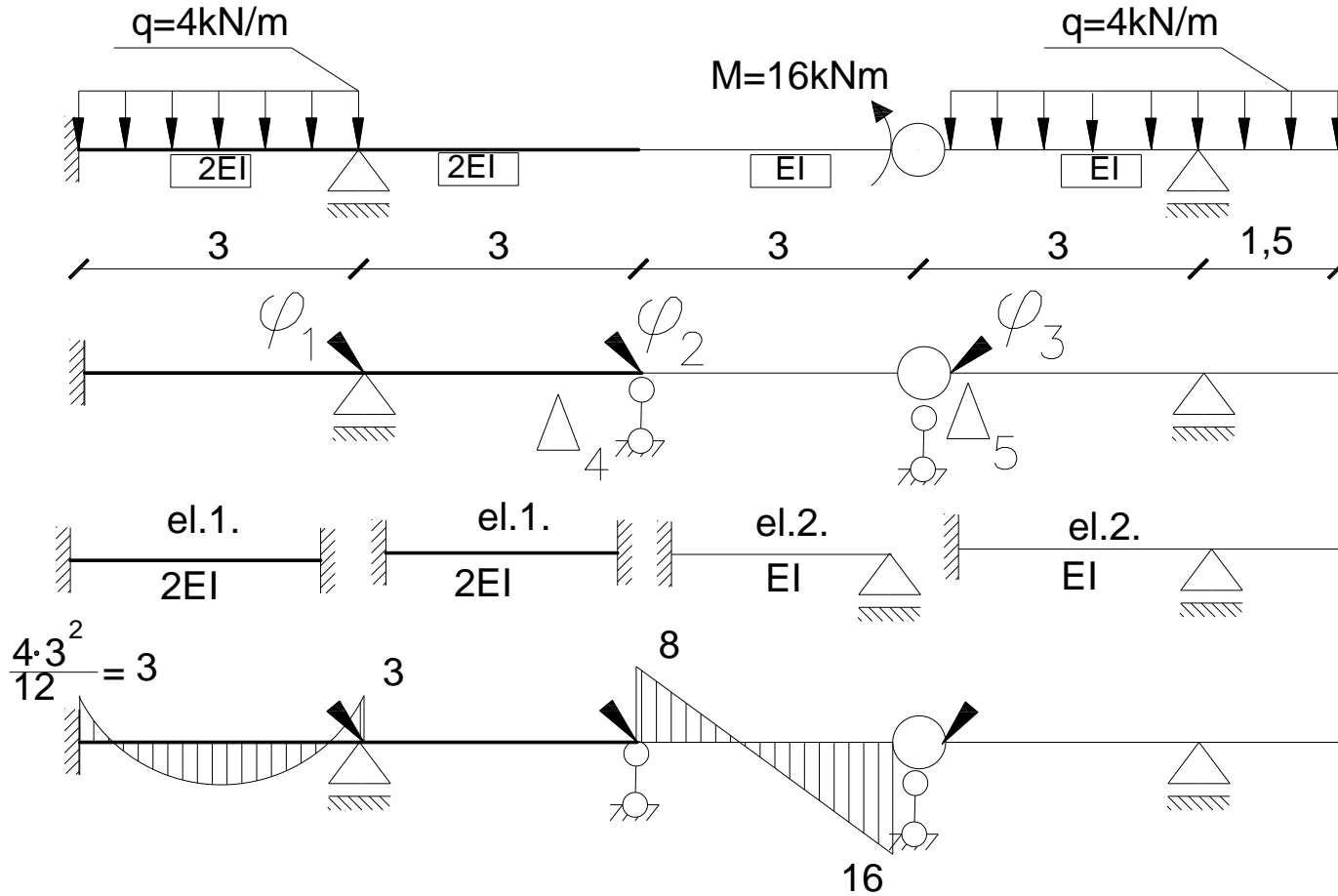

# Wykresy od obciążenia zewnętrznego

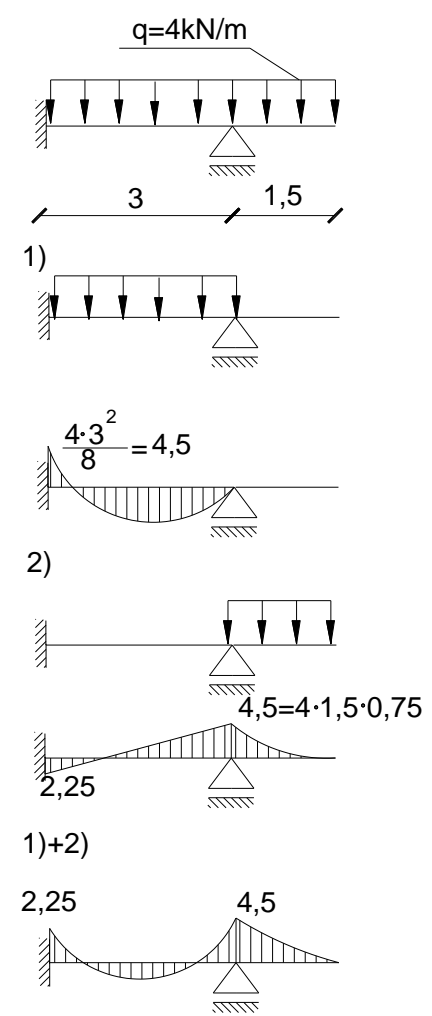
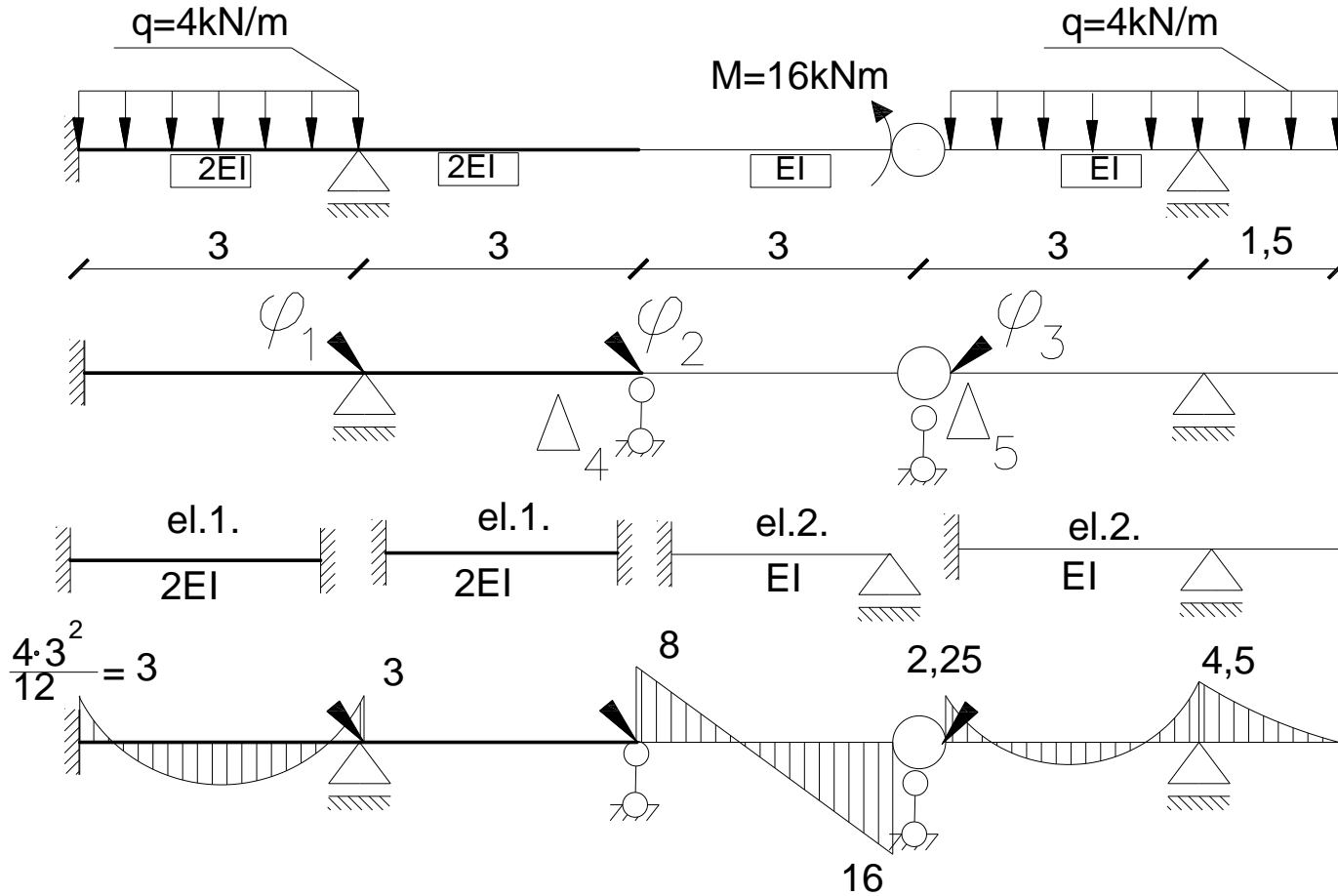

# Wykresy od obciążenia zewnętrznego

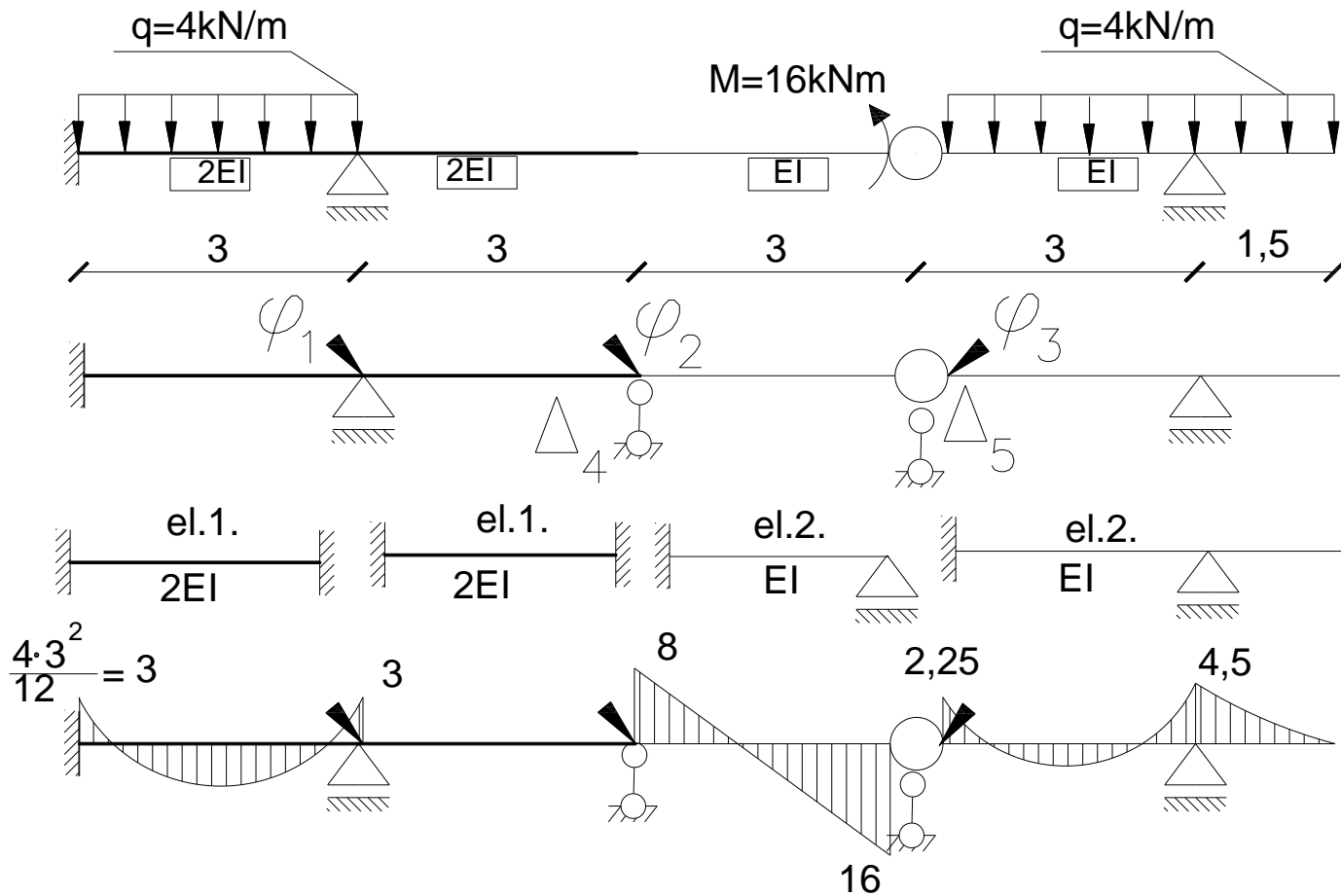

Obciążenie zewnętrzne



# Wykresy od obciążenia zewnętrznego

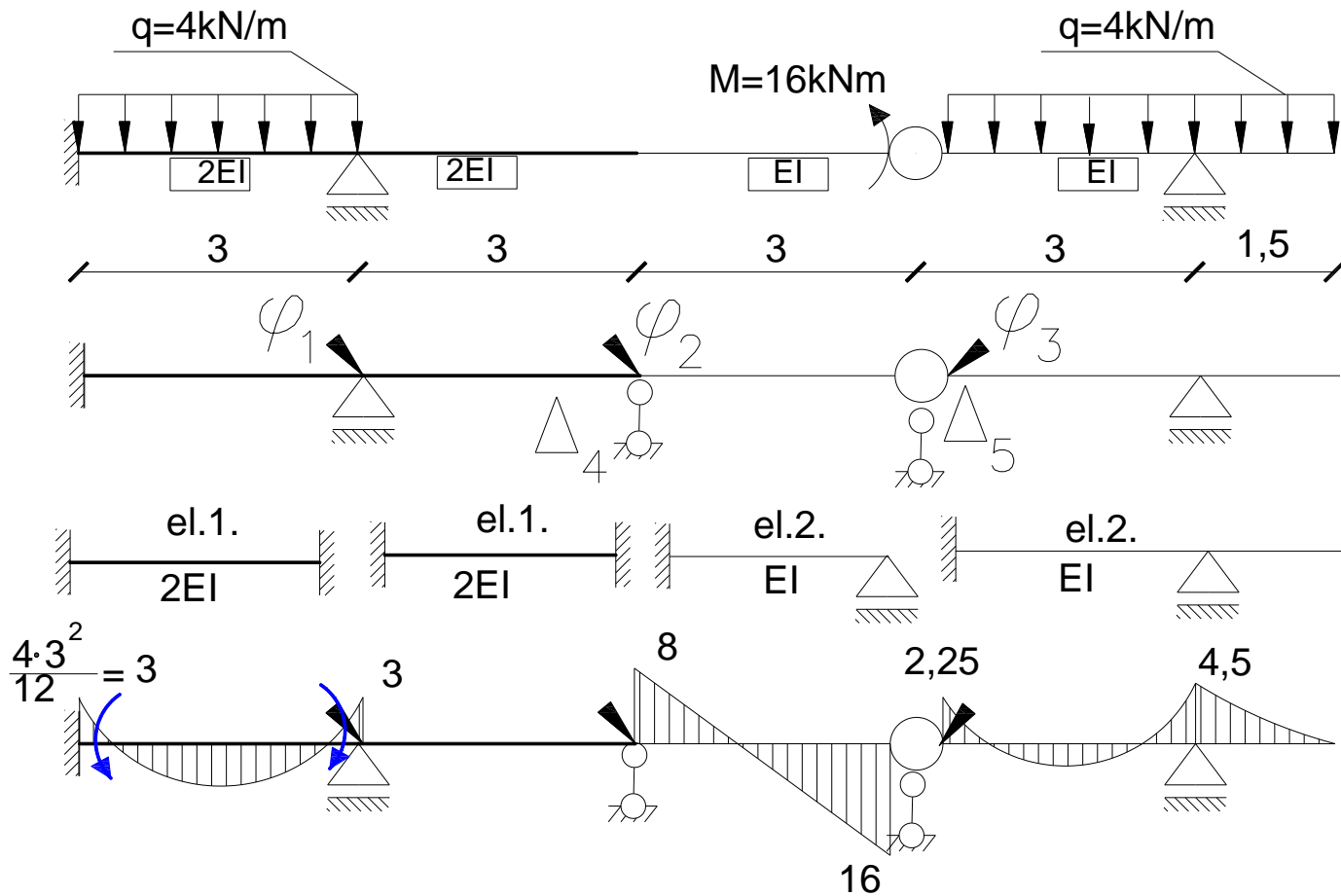

Obciążenie zewnętrzne

# Wykresy od obciążenia zewnętrznego

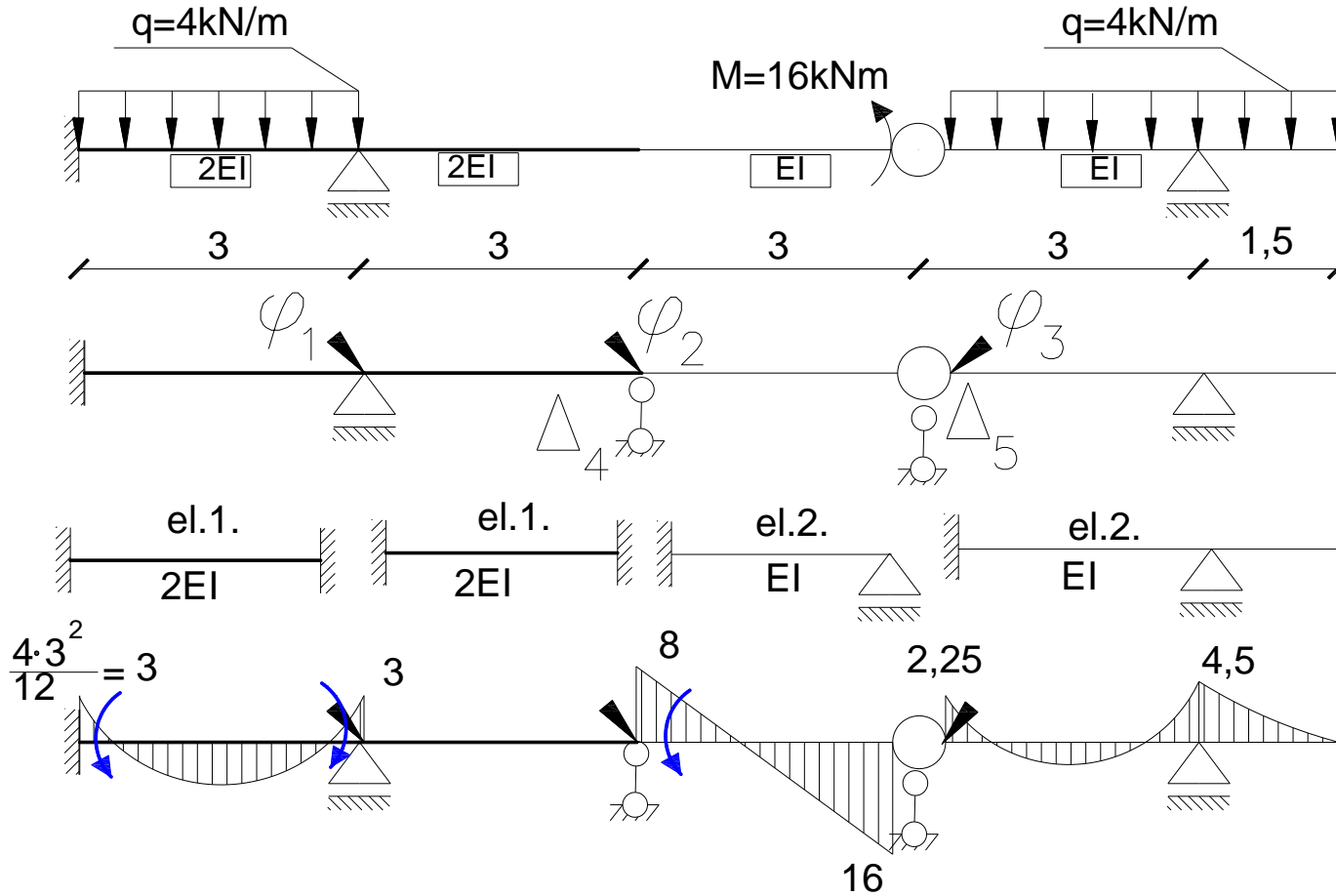

Obciążenie zewnętrzne

# Wykresy od obciążenia zewnętrznego

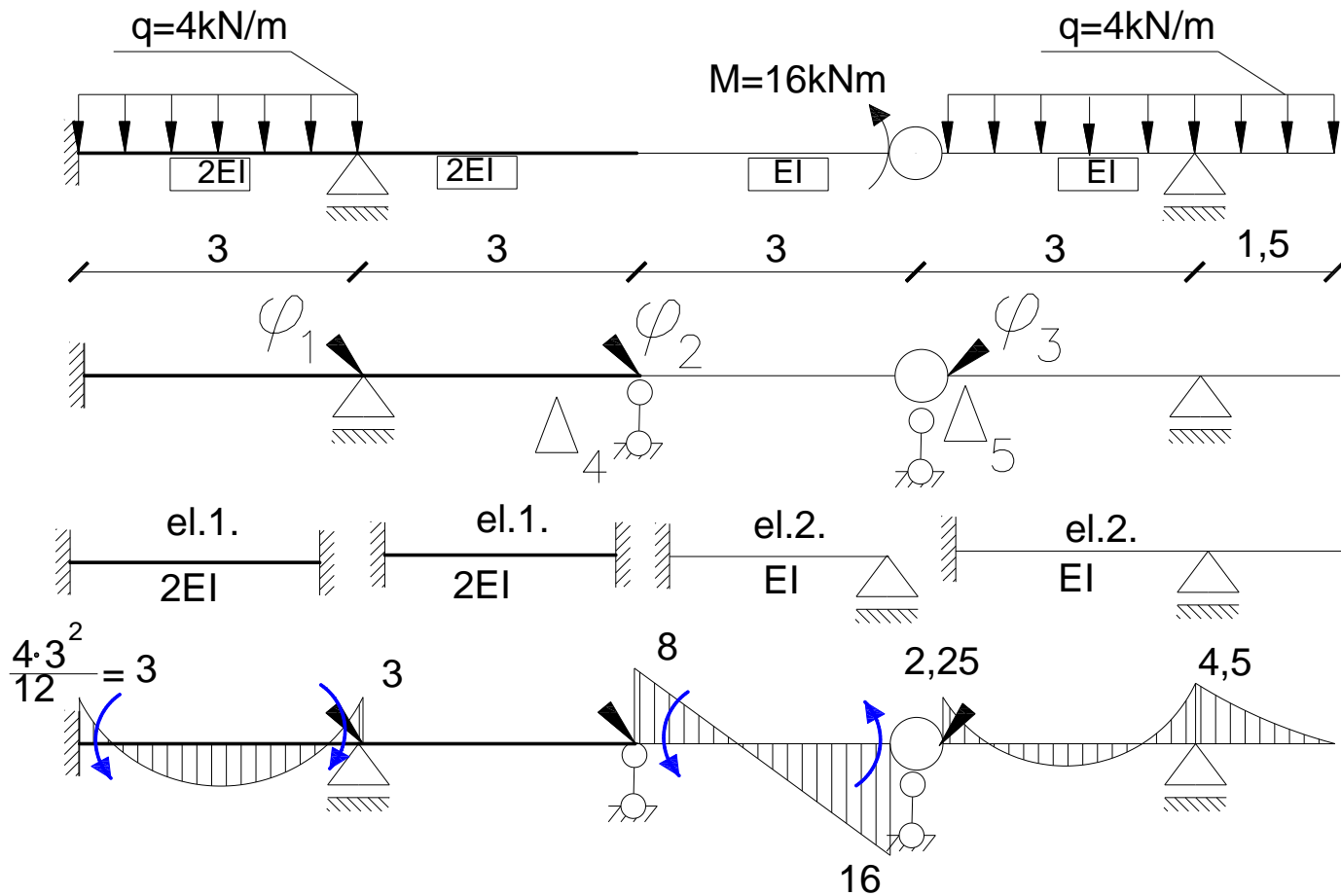

Obciążenie zewnętrzne

# Wykresy od obciążenia zewnętrznego

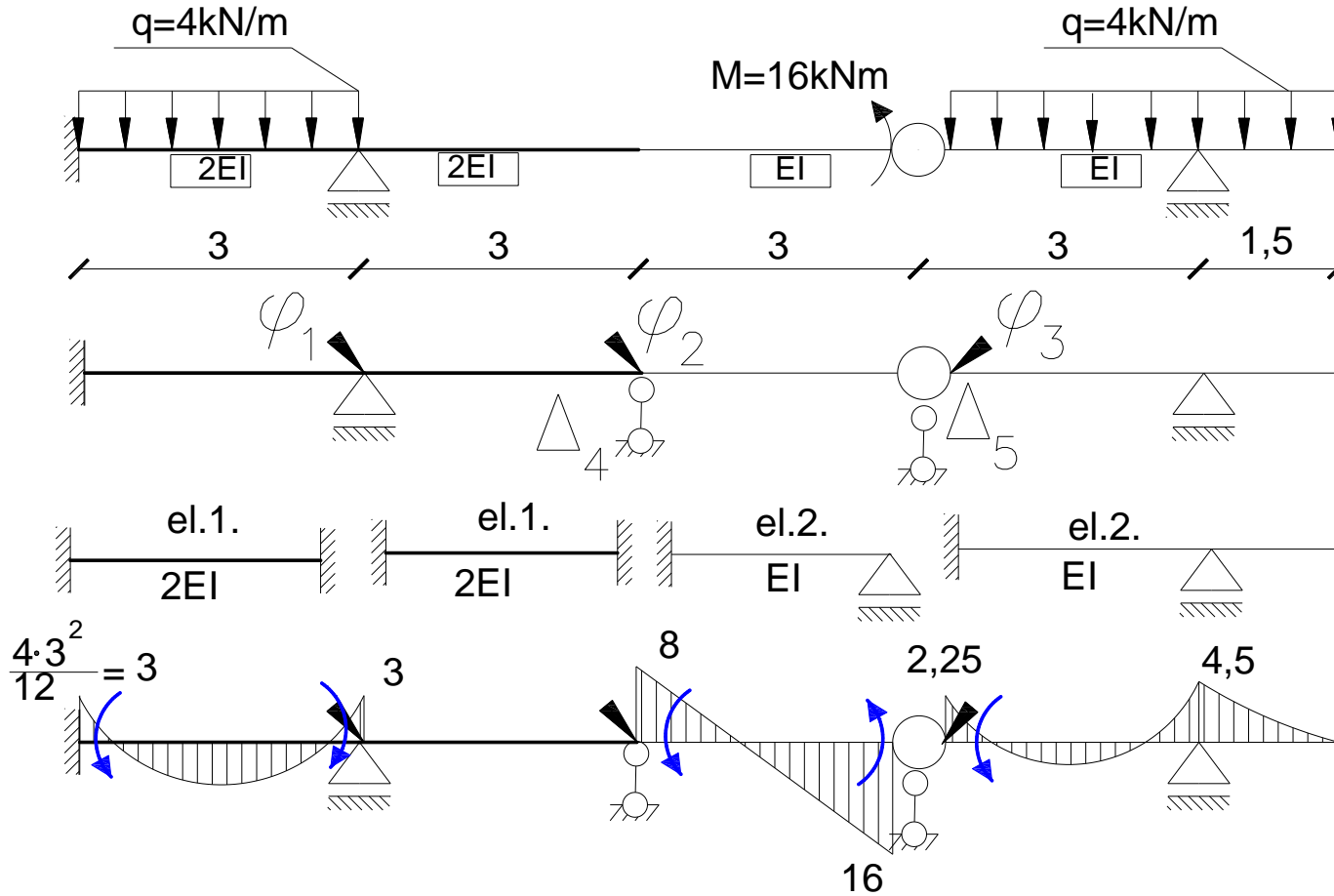

Obciążenie zewnętrzne

# Wykresy od obciążenia zewnętrznego

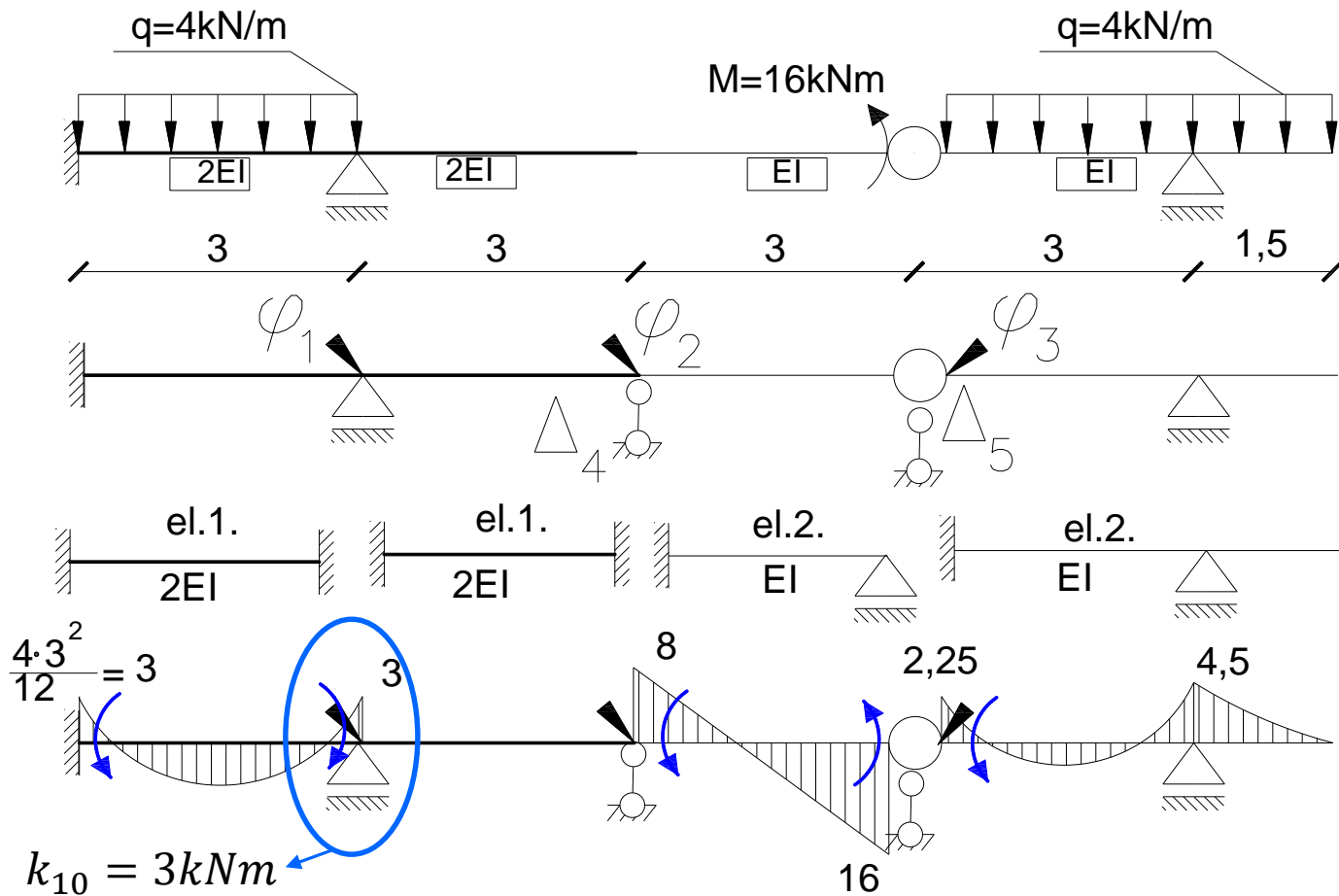

Obciążenie zewnętrzne

# Wykresy od obciążenia zewnętrznego

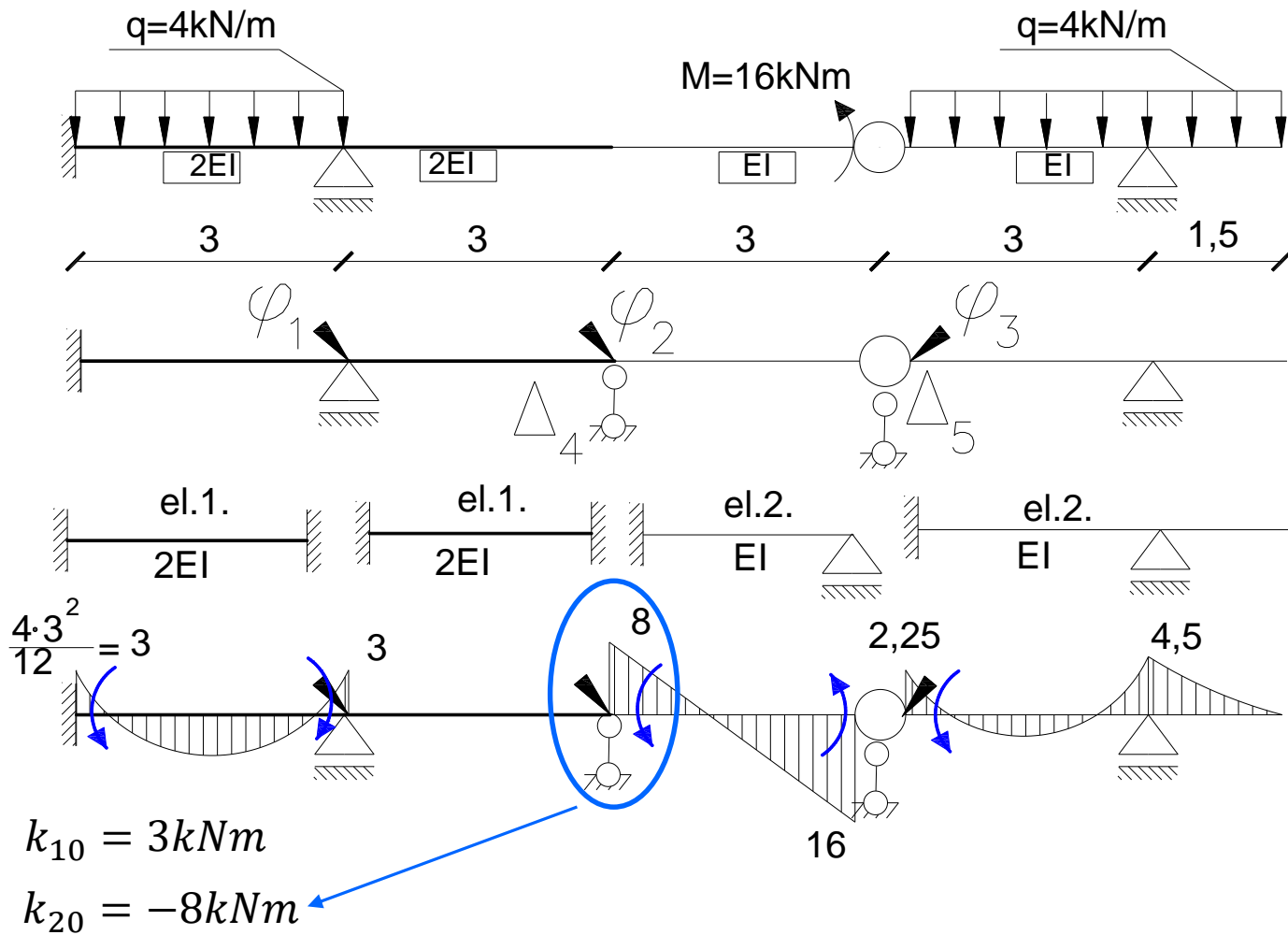

Obciążenie zewnętrzne

# Wykresy od obciążenia zewnętrznego

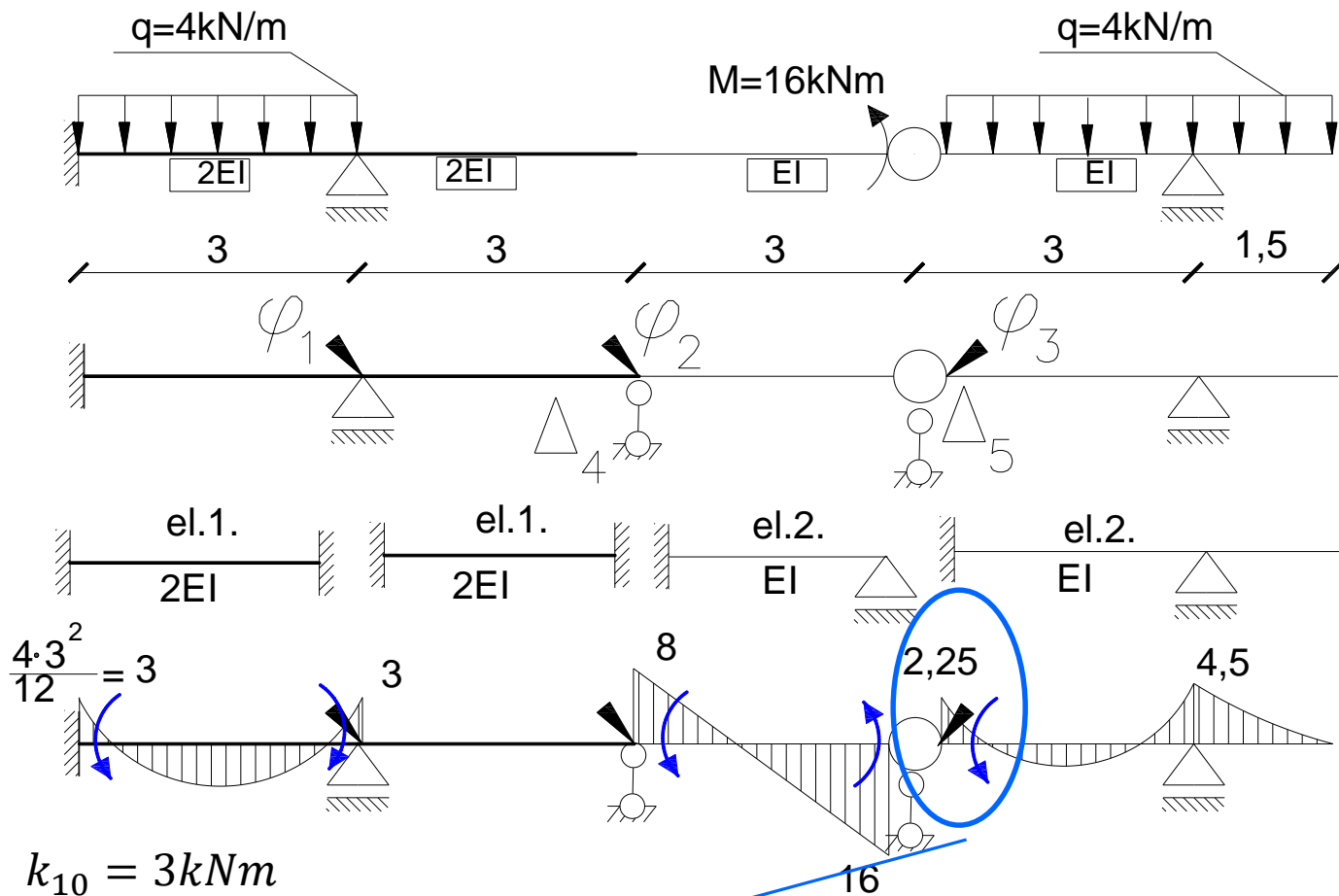

Obciążenie zewnętrzne

$$k_{10} = 3\text{kNm}$$

$$k_{20} = -8\text{kNm}$$

$$k_{30} = -2,25\text{kNm}$$

# Wykresy od obciążenia zewnętrznego

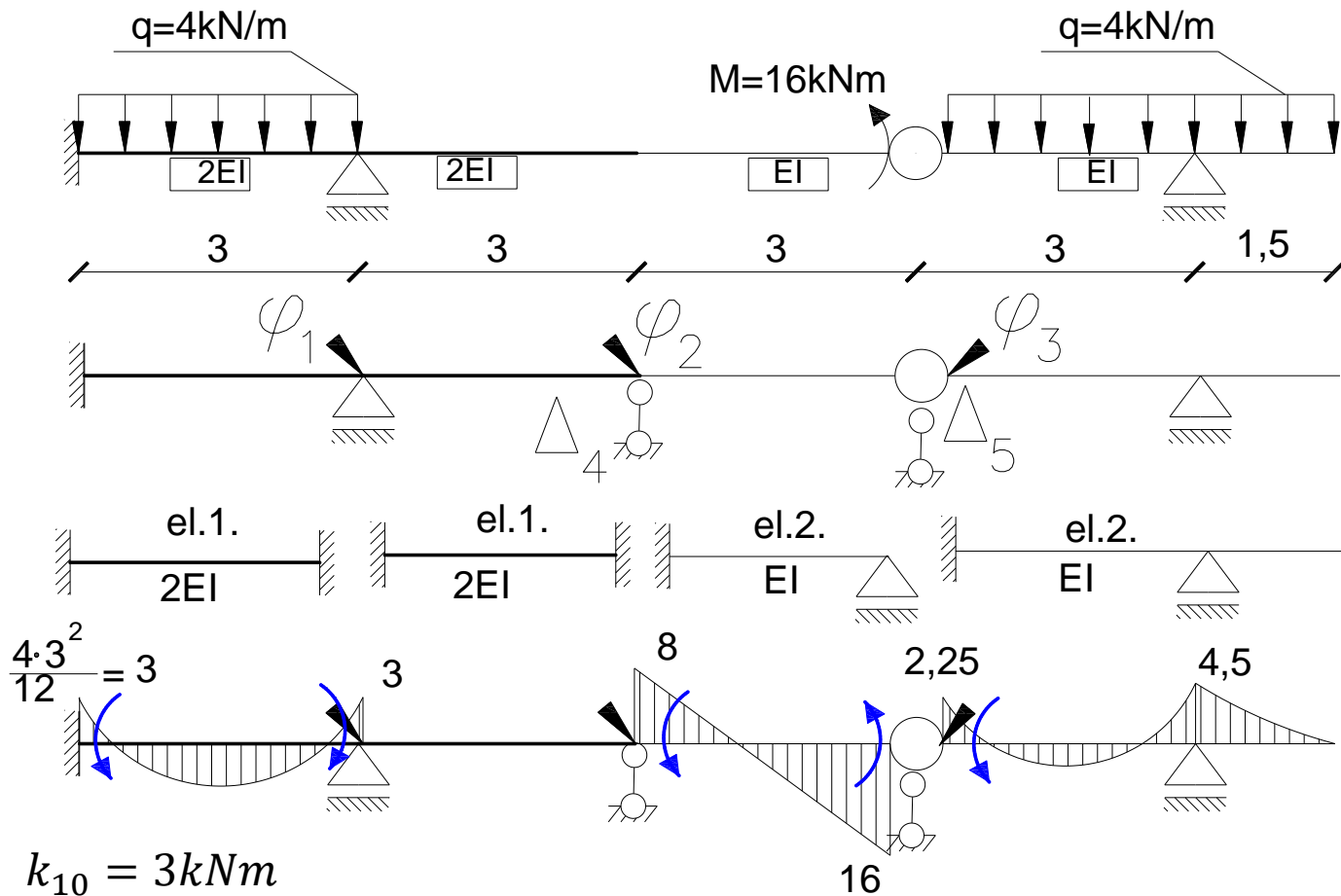

Obciążenie zewnętrzne

$$k_{10} = 3\text{kNm}$$

$$k_{20} = -8\text{kNm}$$

$$k_{30} = -2,25\text{kNm}$$



# Wykresy od obciążenia zewnętrznego

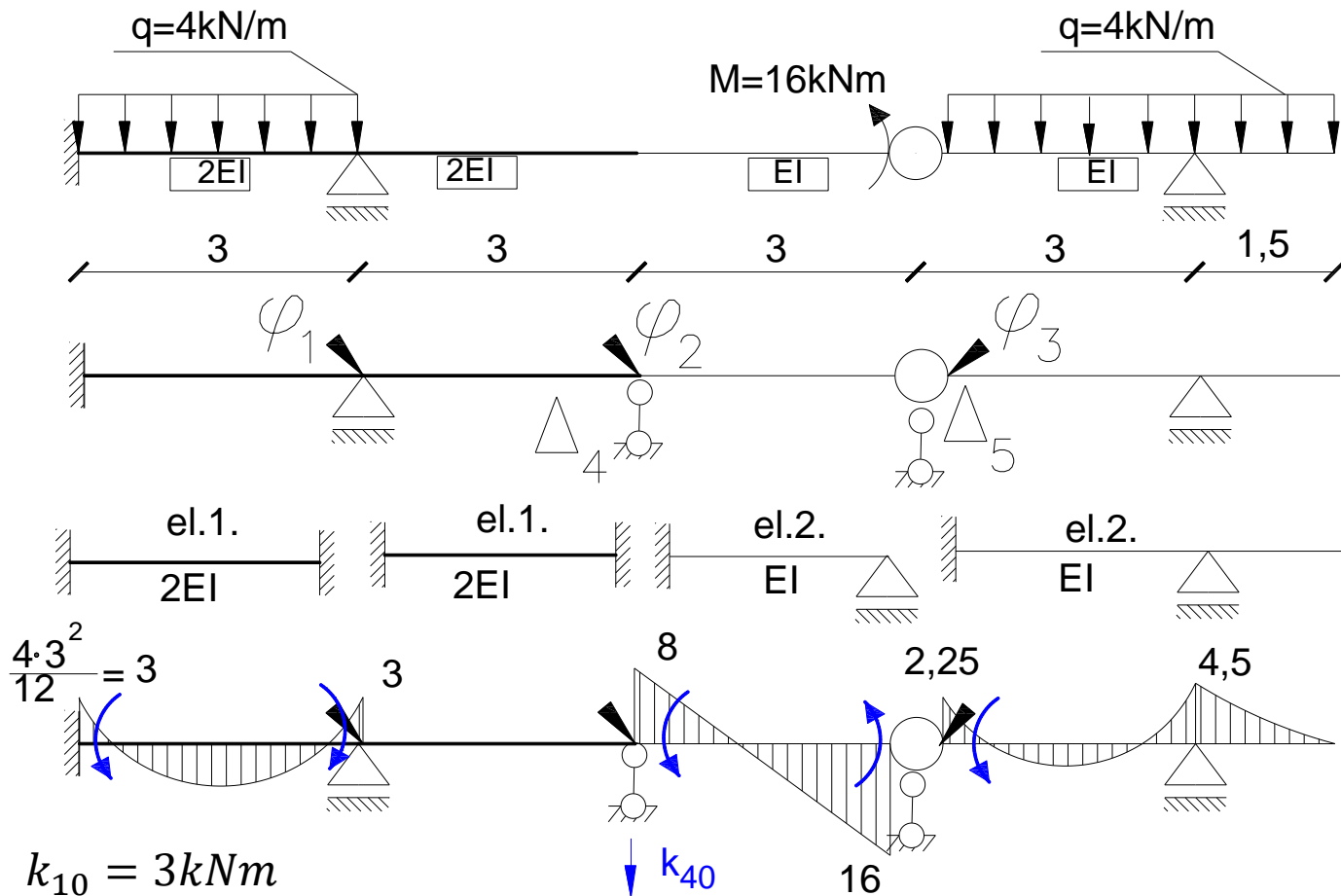

Obciążenie zewnętrzne

# Wykresy od obciążenia zewnętrznego

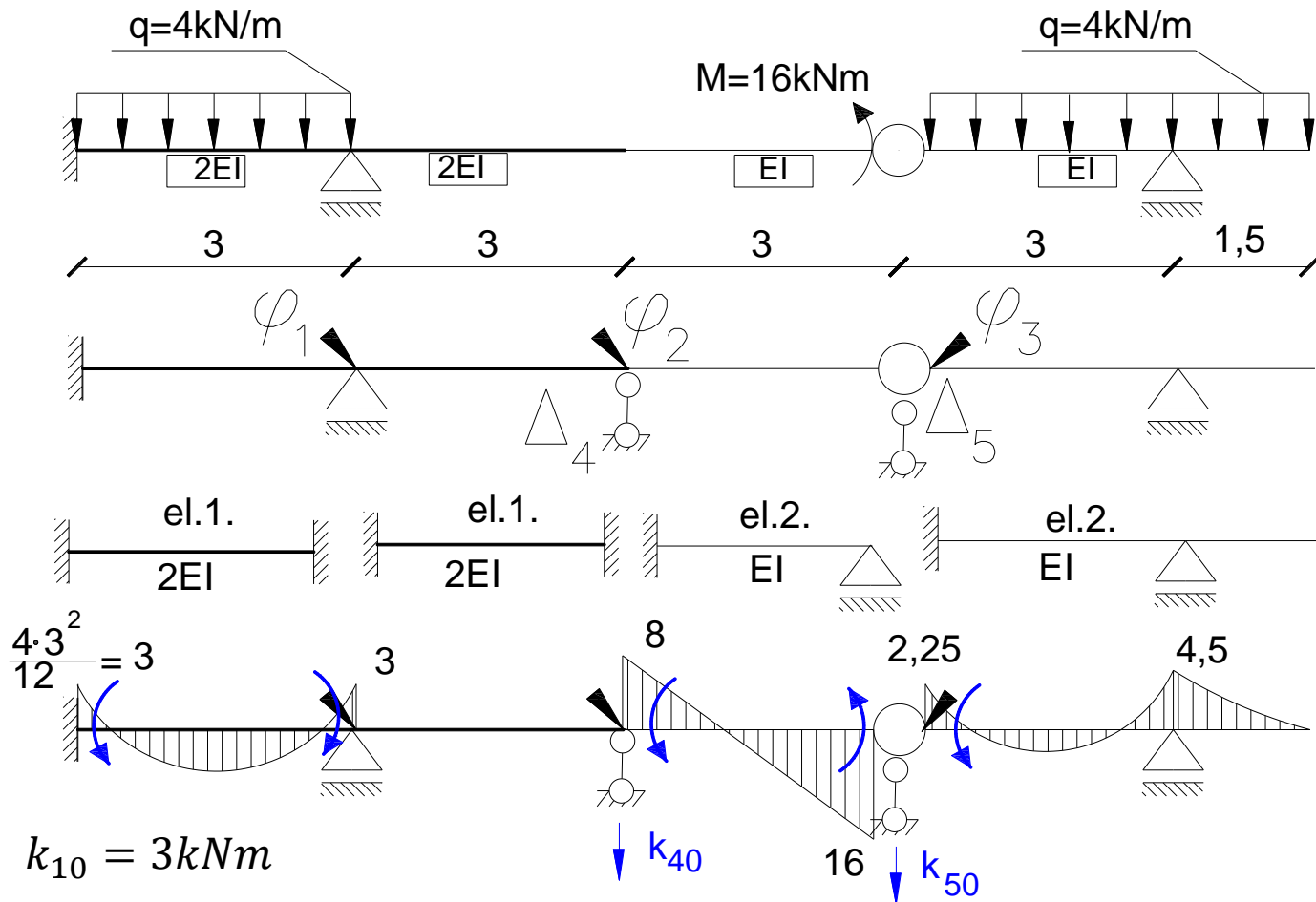

Obciążenie zewnętrzne

# Wykresy od obciążenia zewnętrznego

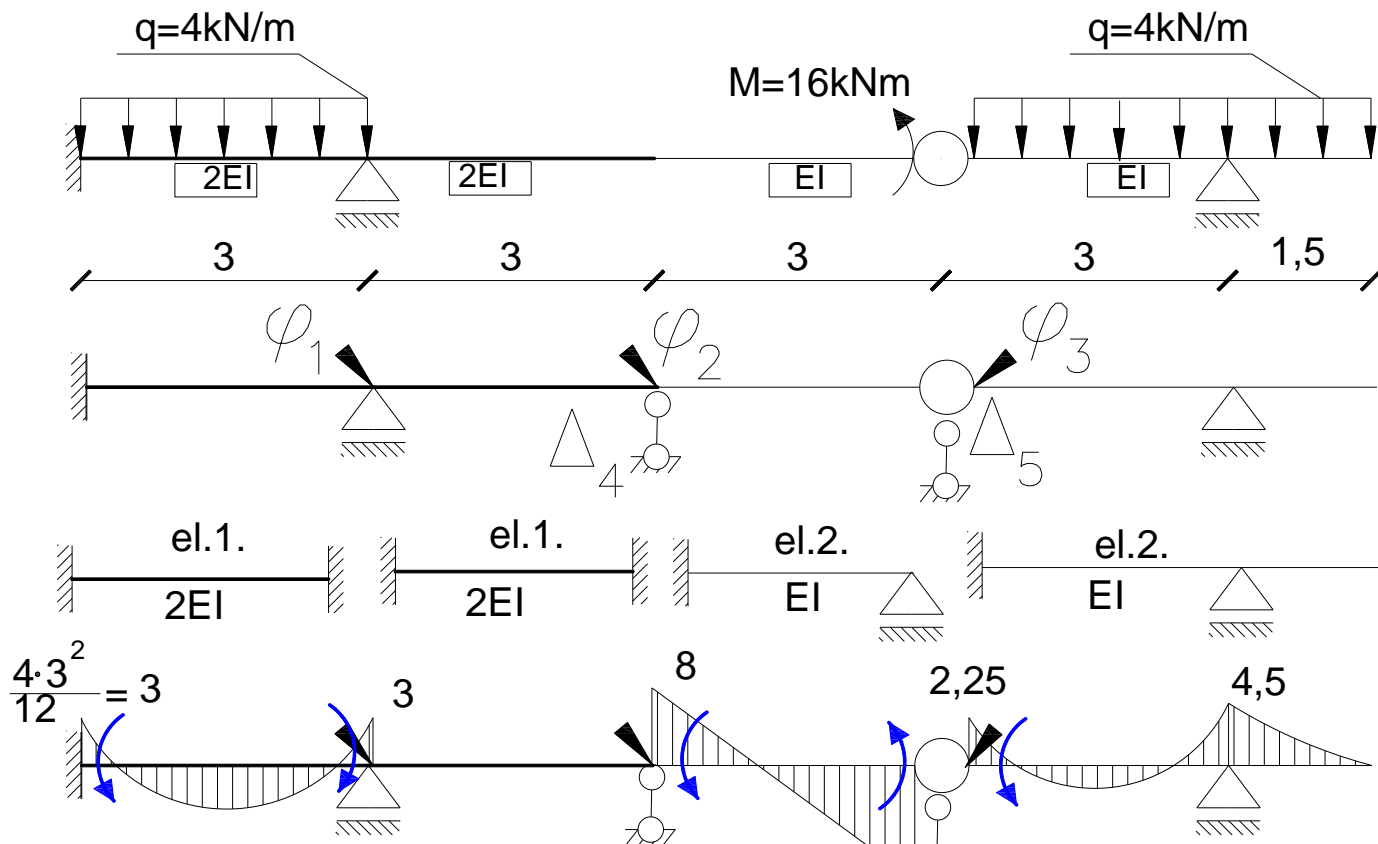

Obciążenie zewnętrzne

$$k_{10} = 3\text{kNm}$$

$$k_{20} = -8\text{kNm}$$

$$k_{30} = -2,25\text{kNm}$$

$$k_{40}$$

$$k_{50}$$

$$k_{40}$$

3

# Wykresy od obciążenia zewnętrznego

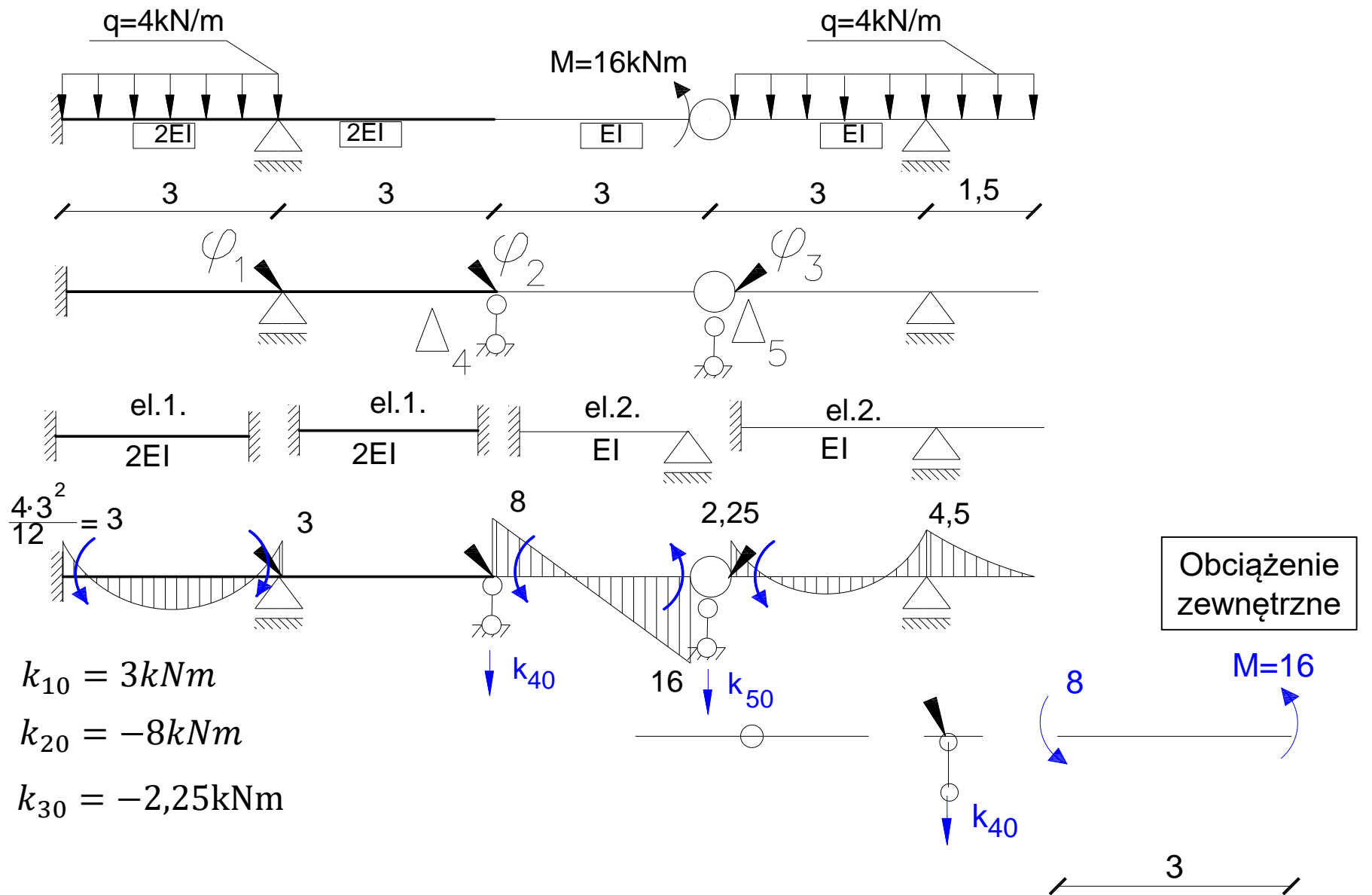

# Wykresy od obciążenia zewnętrznego

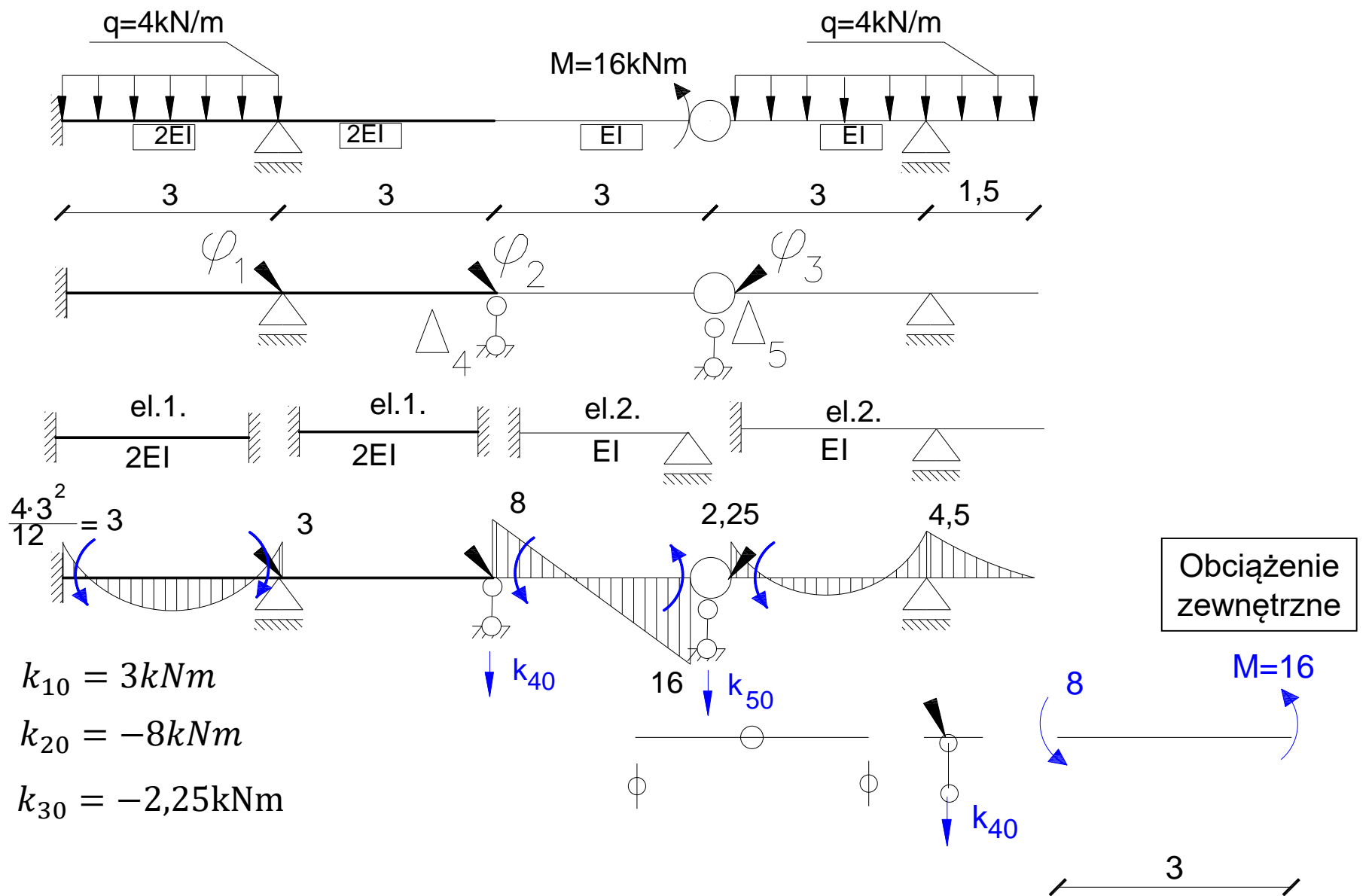

# Wykresy od obciążenia zewnętrznego

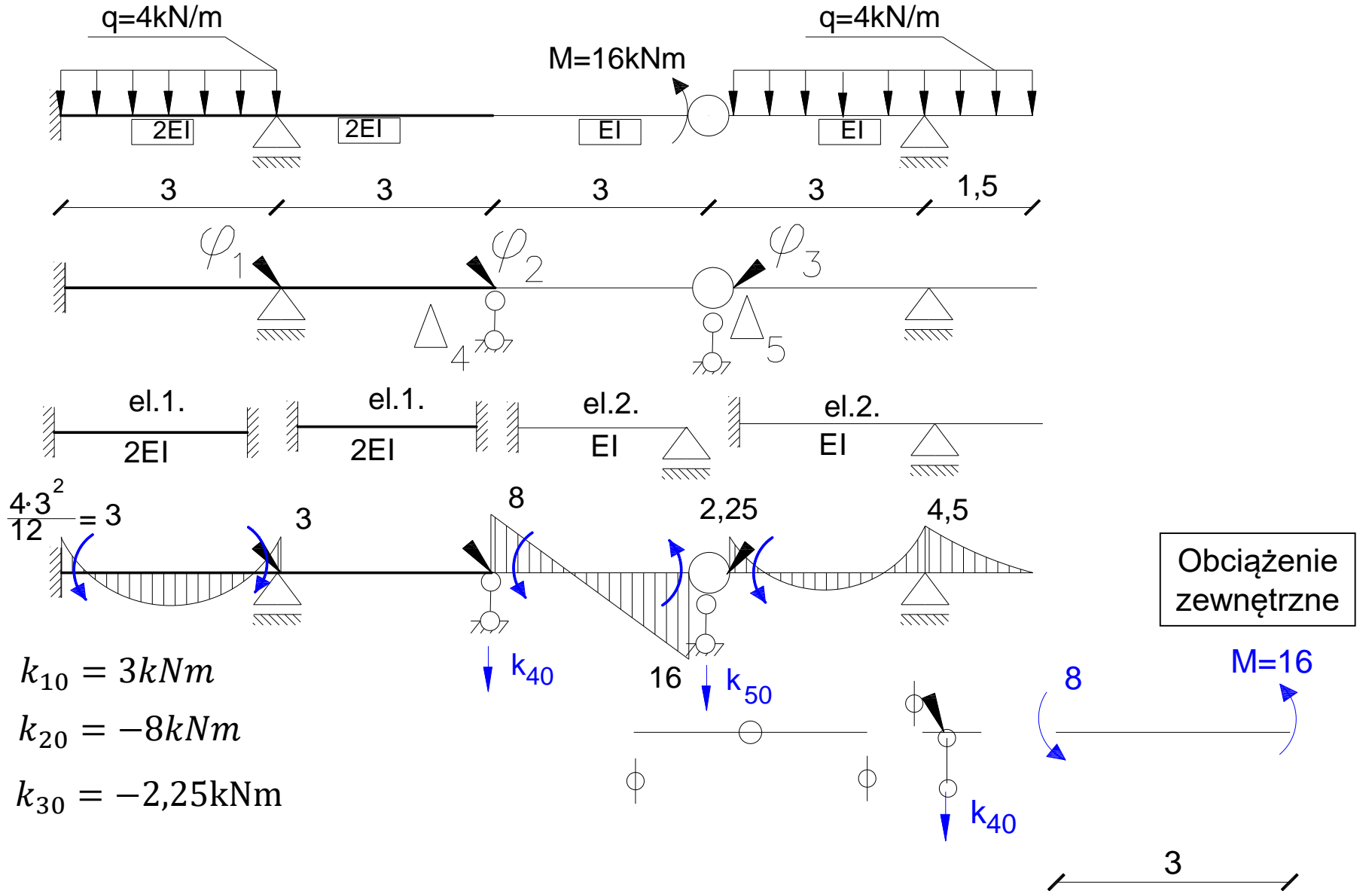

# Wykresy od obciążenia zewnętrznego

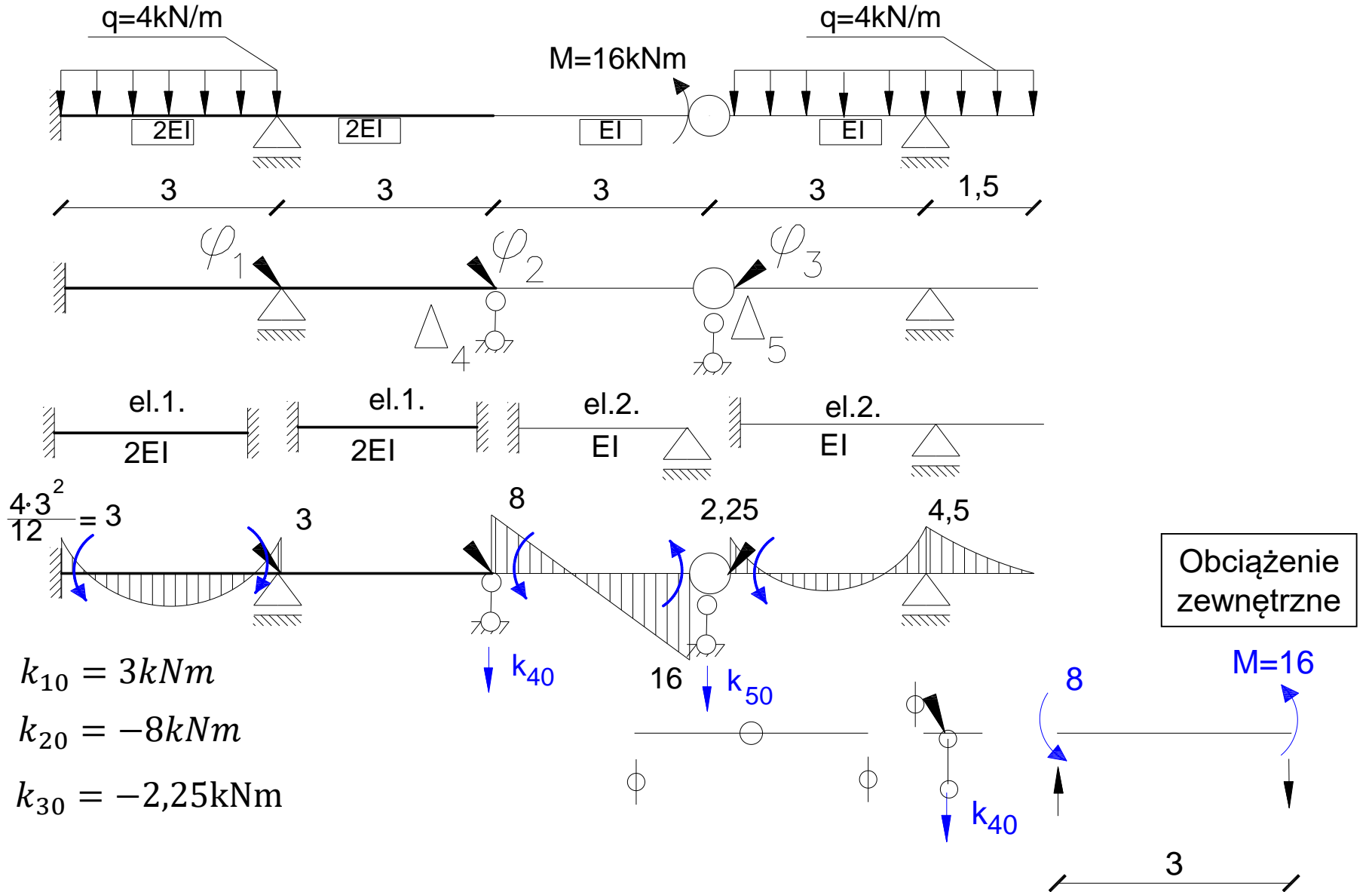

# Wykresy od obciążenia zewnętrznego

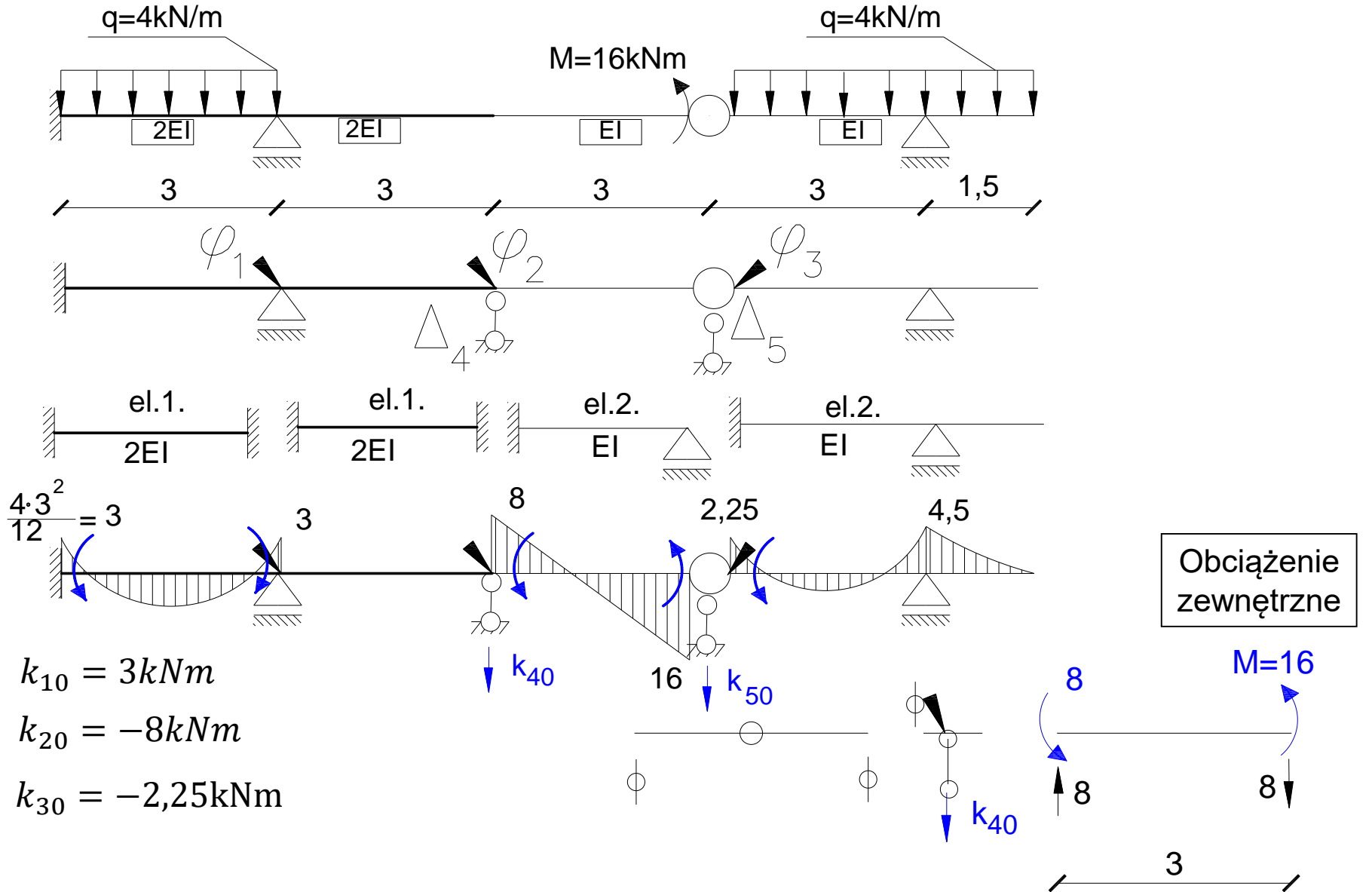



# Wykresy od obciążenia zewnętrznego

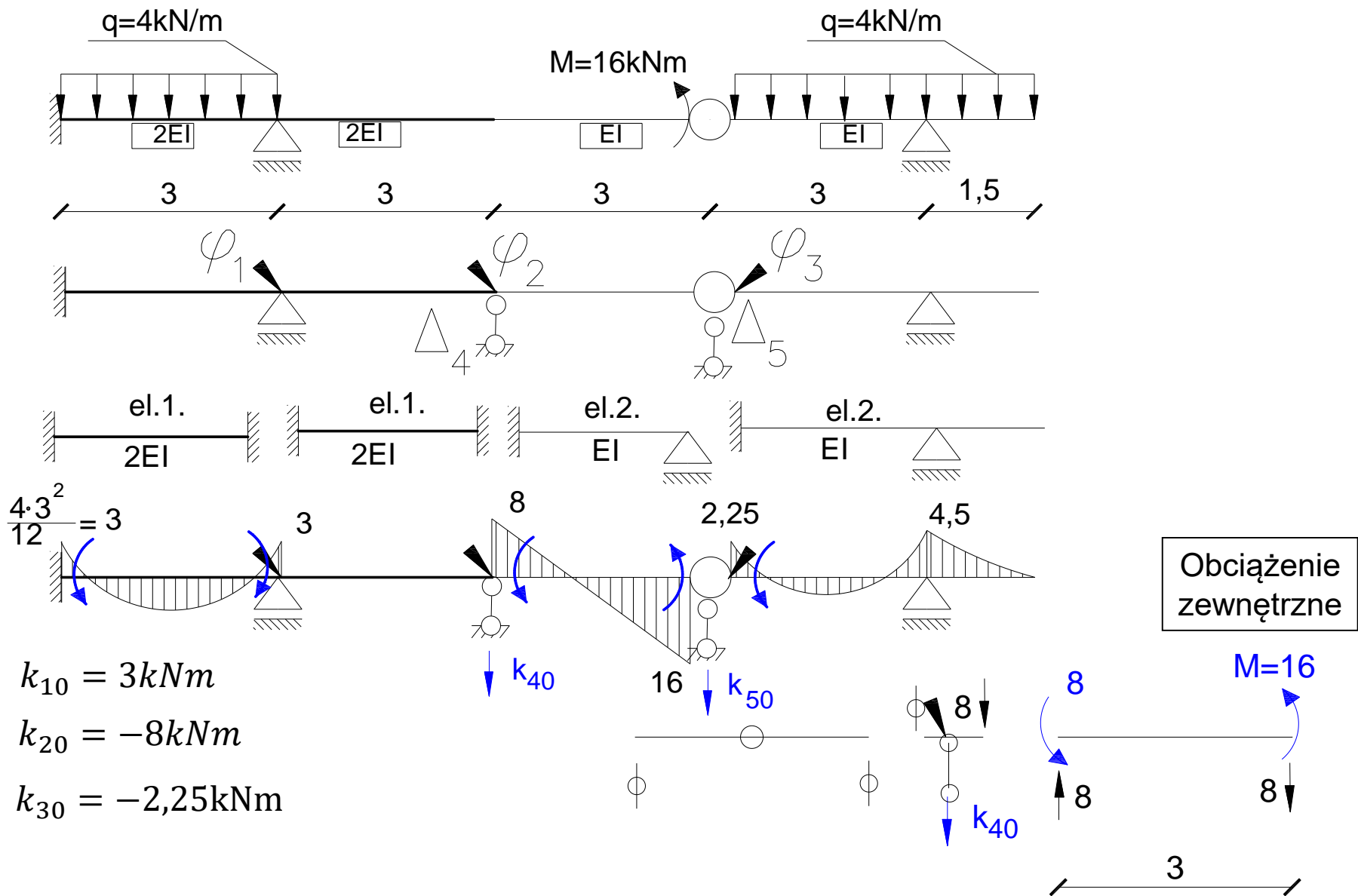

# Wykresy od obciążenia zewnętrznego

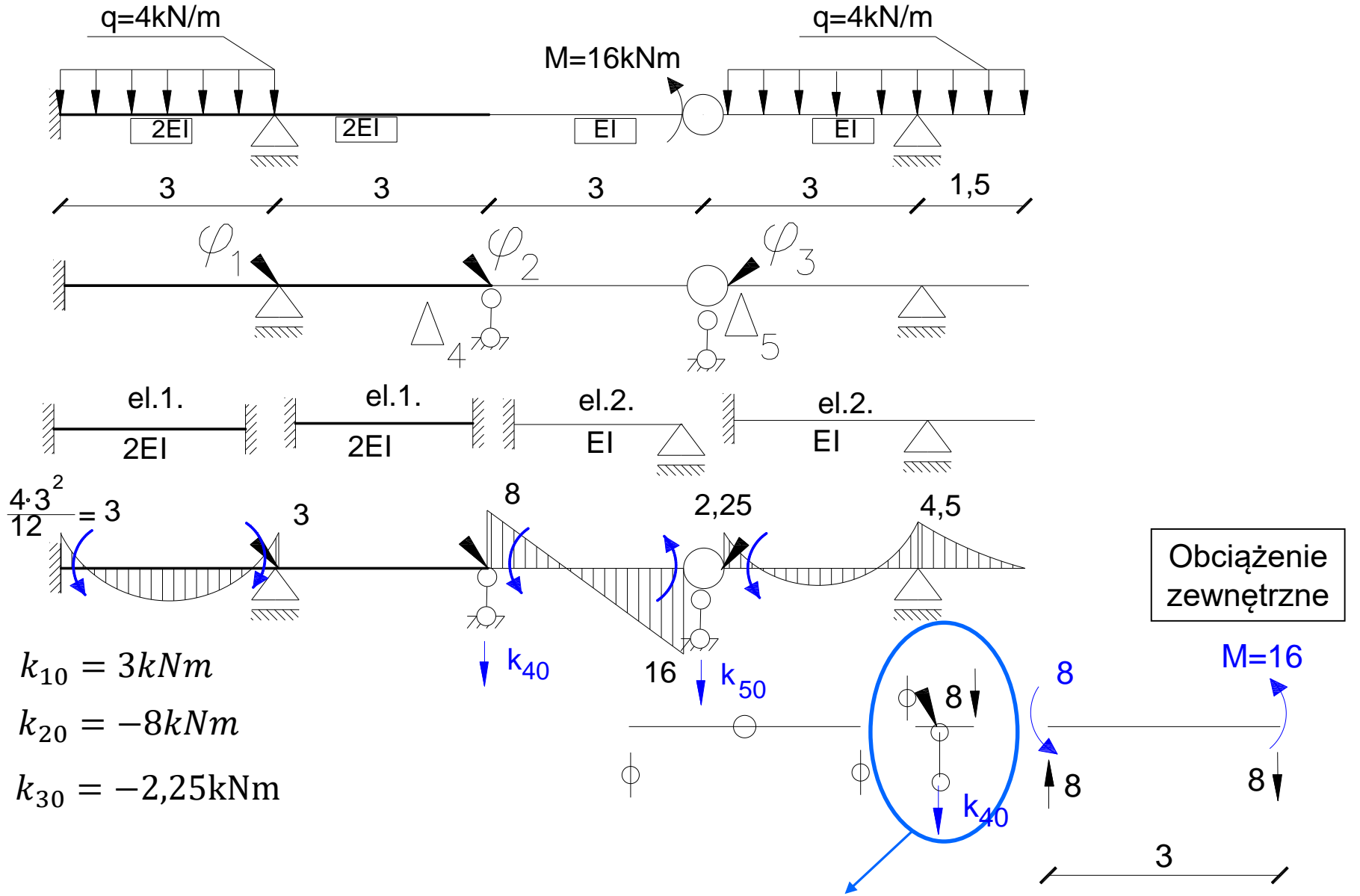

# Wykresy od obciążenia zewnętrznego

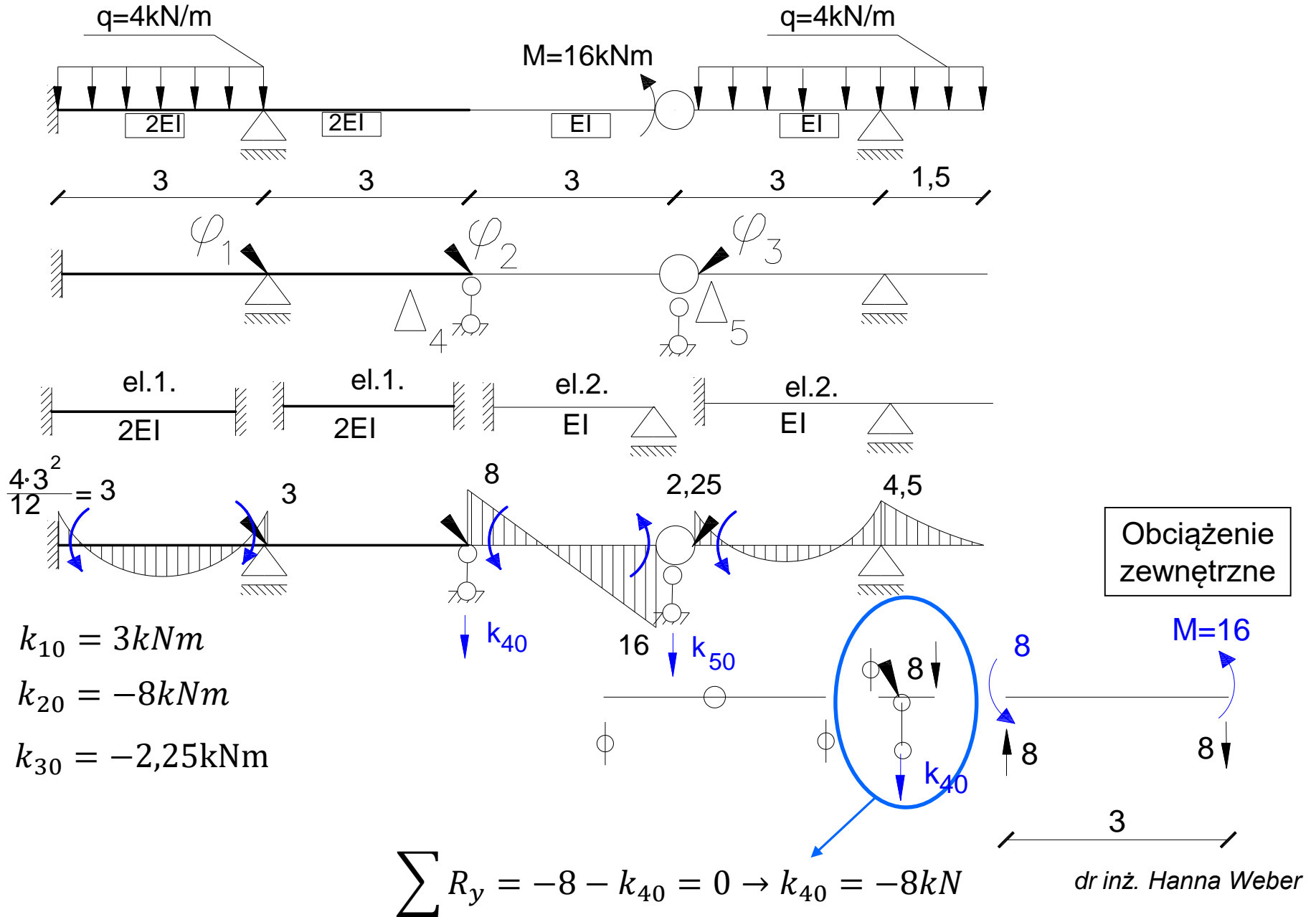

# Wykresy od obciążenia zewnętrznego

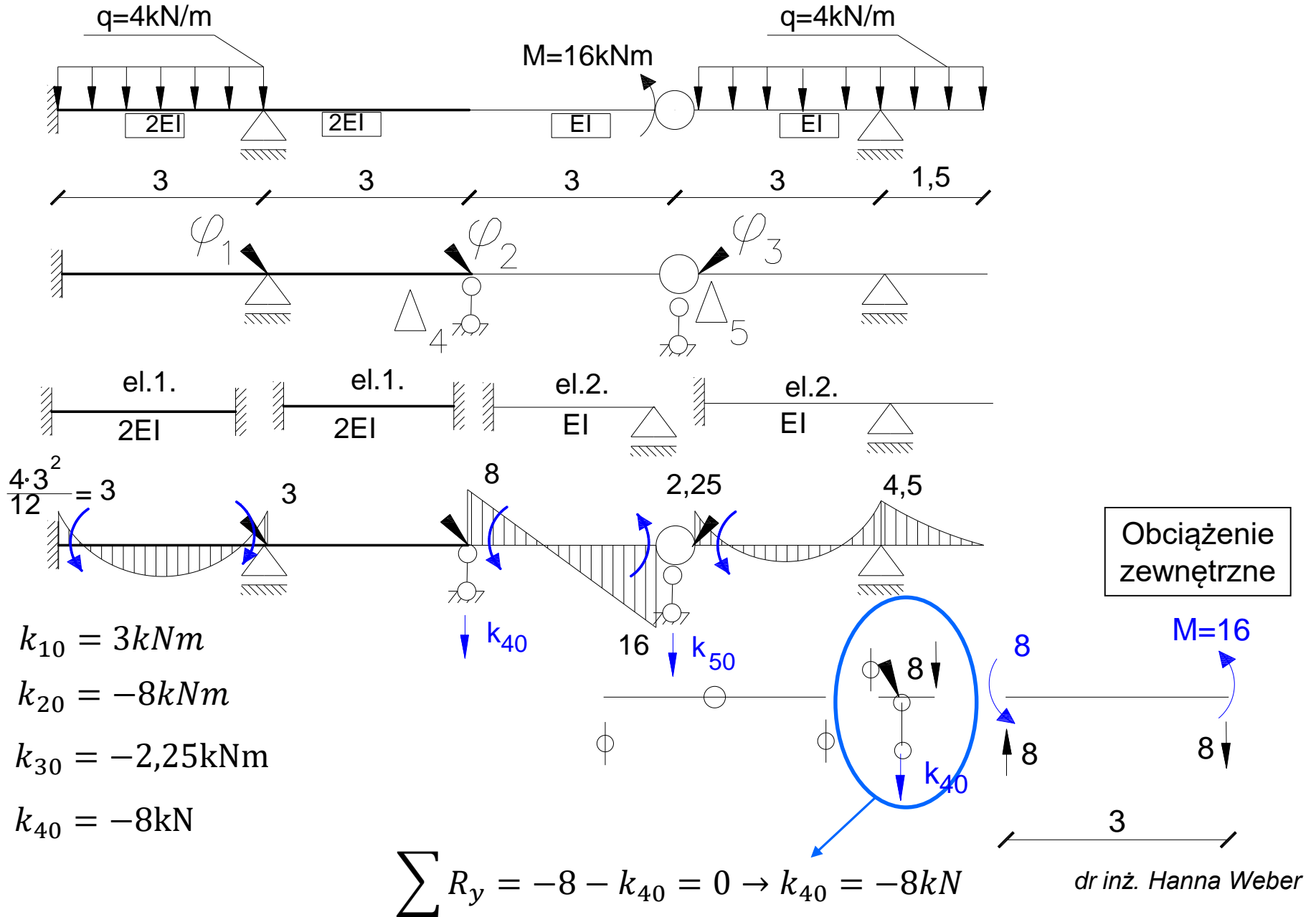

# Wykresy od obciążenia zewnętrznego

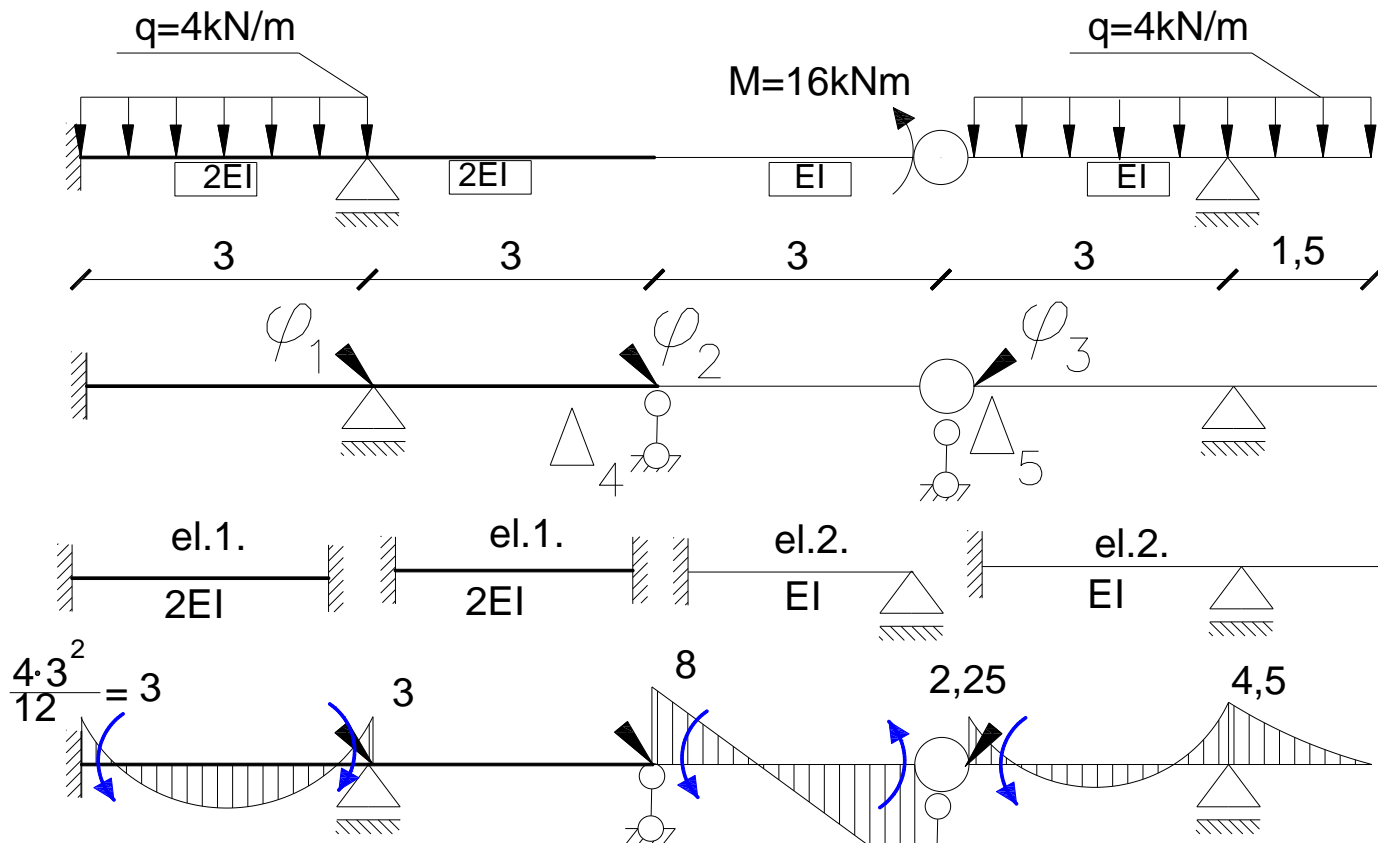

Obciążenie zewnętrzne

$$k_{10} = 3\text{kNm}$$

$$k_{20} = -8\text{kNm}$$

$$k_{30} = -2,25\text{kNm}$$

$$k_{40} = -8\text{kN}$$

$$16 \downarrow k_{50}$$

$$\downarrow k_{50}$$

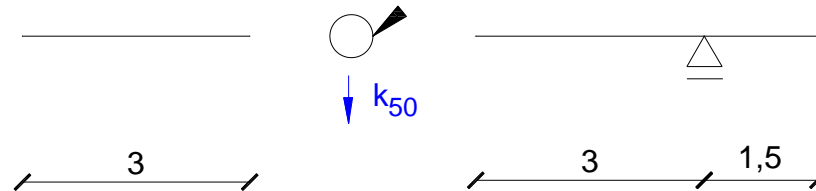

# Wykresy od obciążenia zewnętrznego

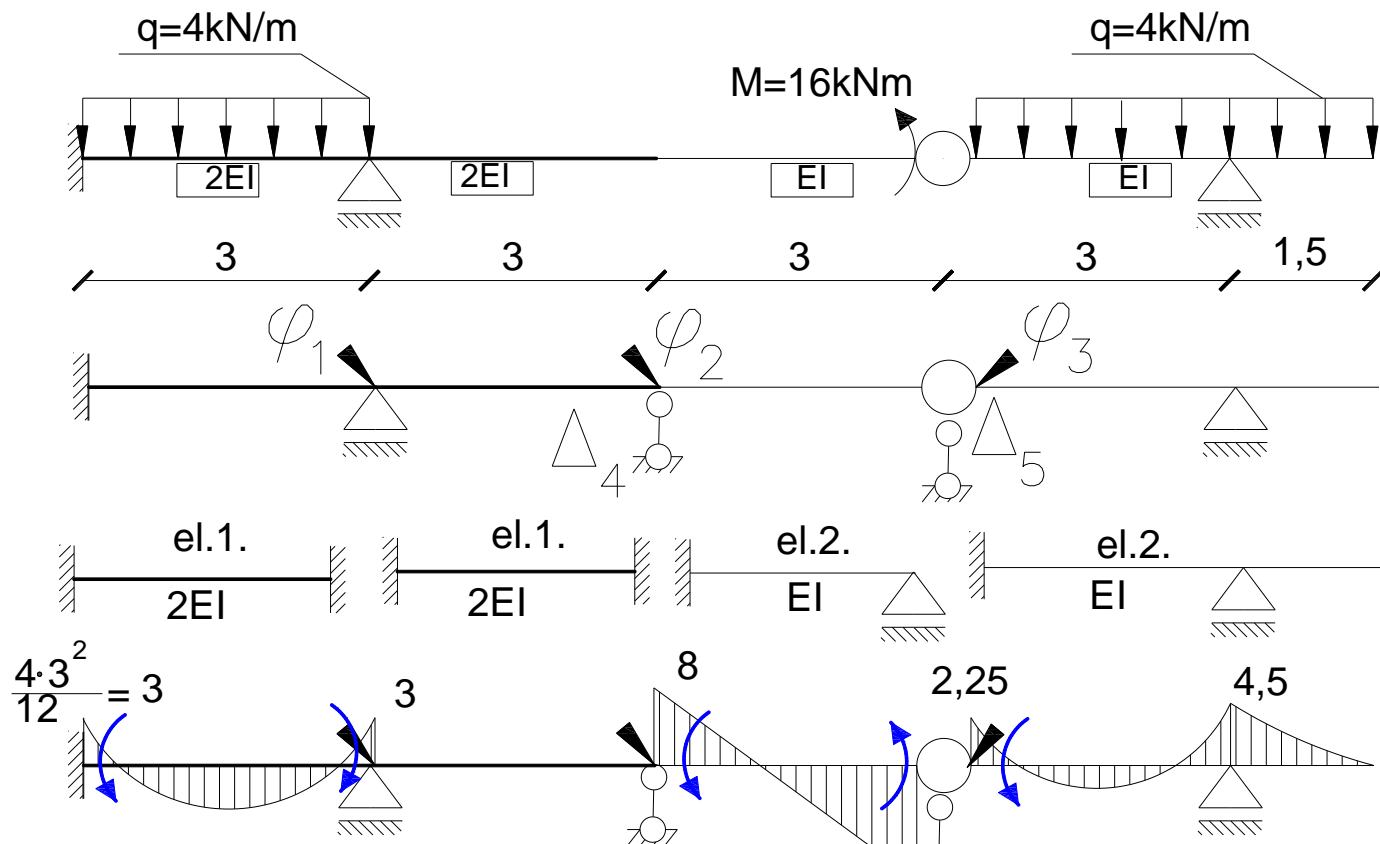

Obciążenie zewnętrzne

$$k_{10} = 3\text{kNm}$$

$$k_{20} = -8\text{kNm}$$

$$k_{30} = -2,25\text{kNm}$$

$$k_{40} = -8\text{kN}$$

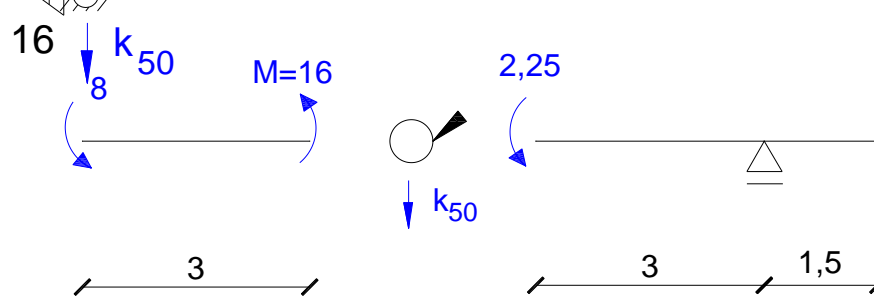

# Wykresy od obciążenia zewnętrznego

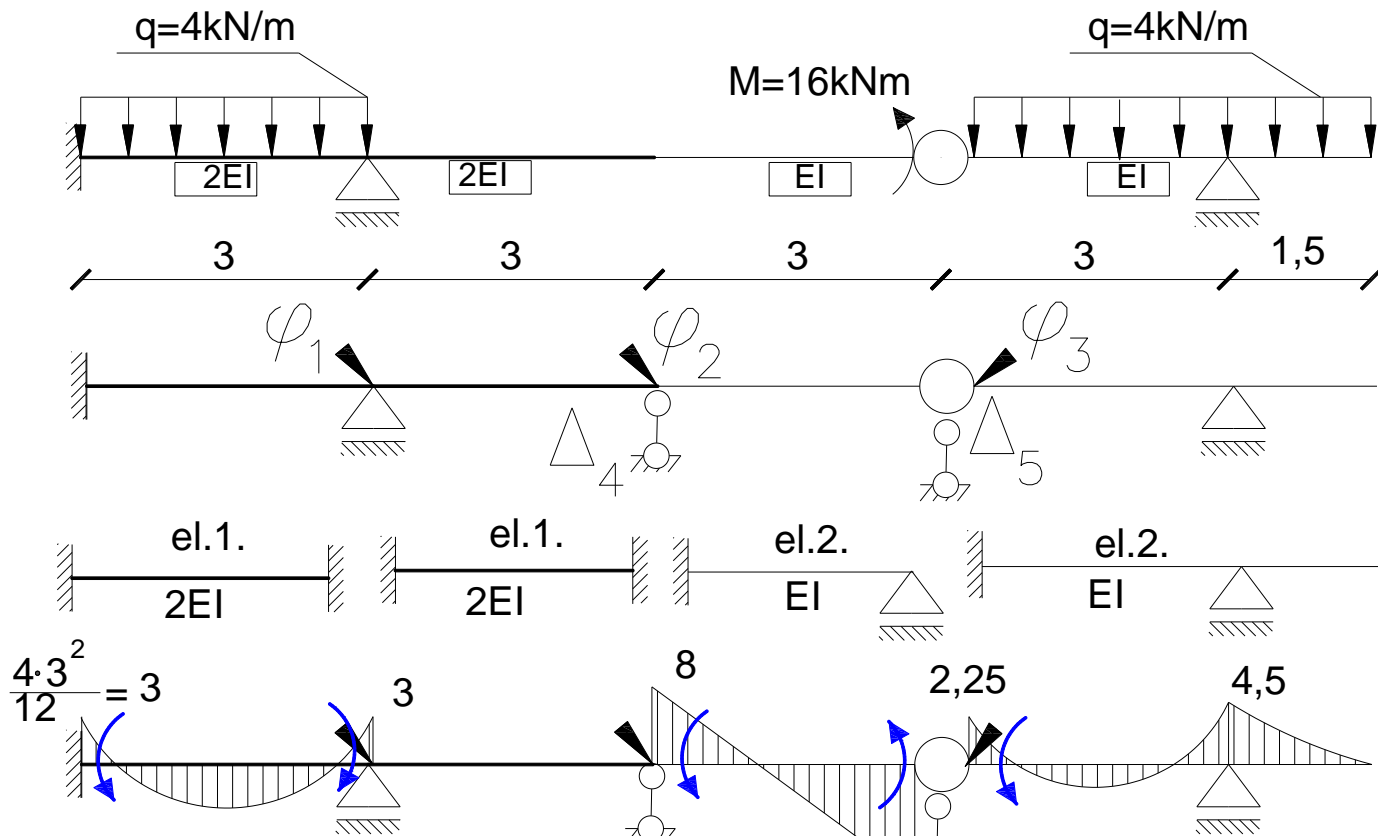

$$k_{10} = 3\text{kNm}$$

$$k_{20} = -8\text{kNm}$$

$$k_{30} = -2,25\text{kNm}$$

$$k_{40} = -8\text{kN}$$

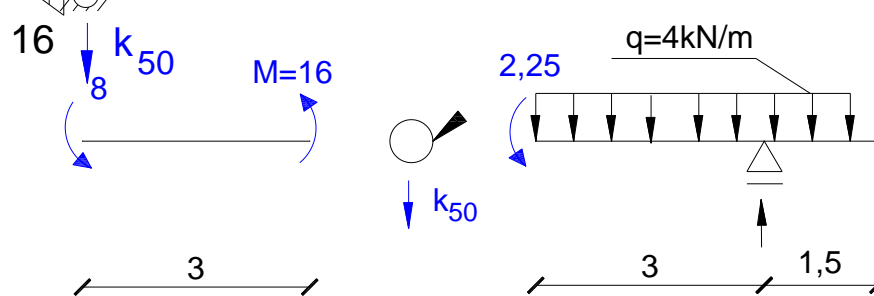

# Wykresy od obciążenia zewnętrznego

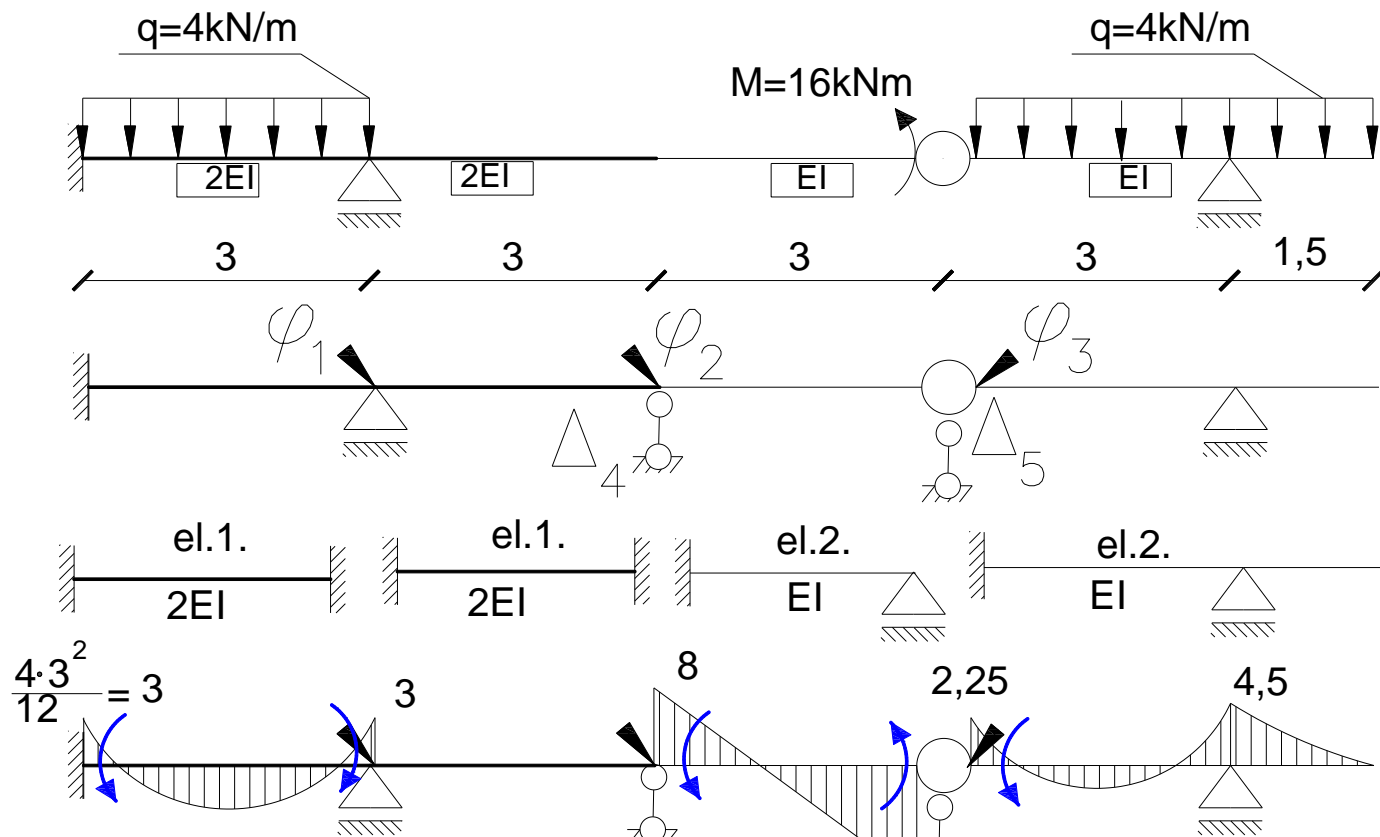

Obciążenie zewnętrzne

$$k_{10} = 3\text{kNm}$$

$$k_{20} = -8\text{kNm}$$

$$k_{30} = -2,25\text{kNm}$$

$$k_{40} = -8\text{kN}$$



# Wykresy od obciążenia zewnętrznego

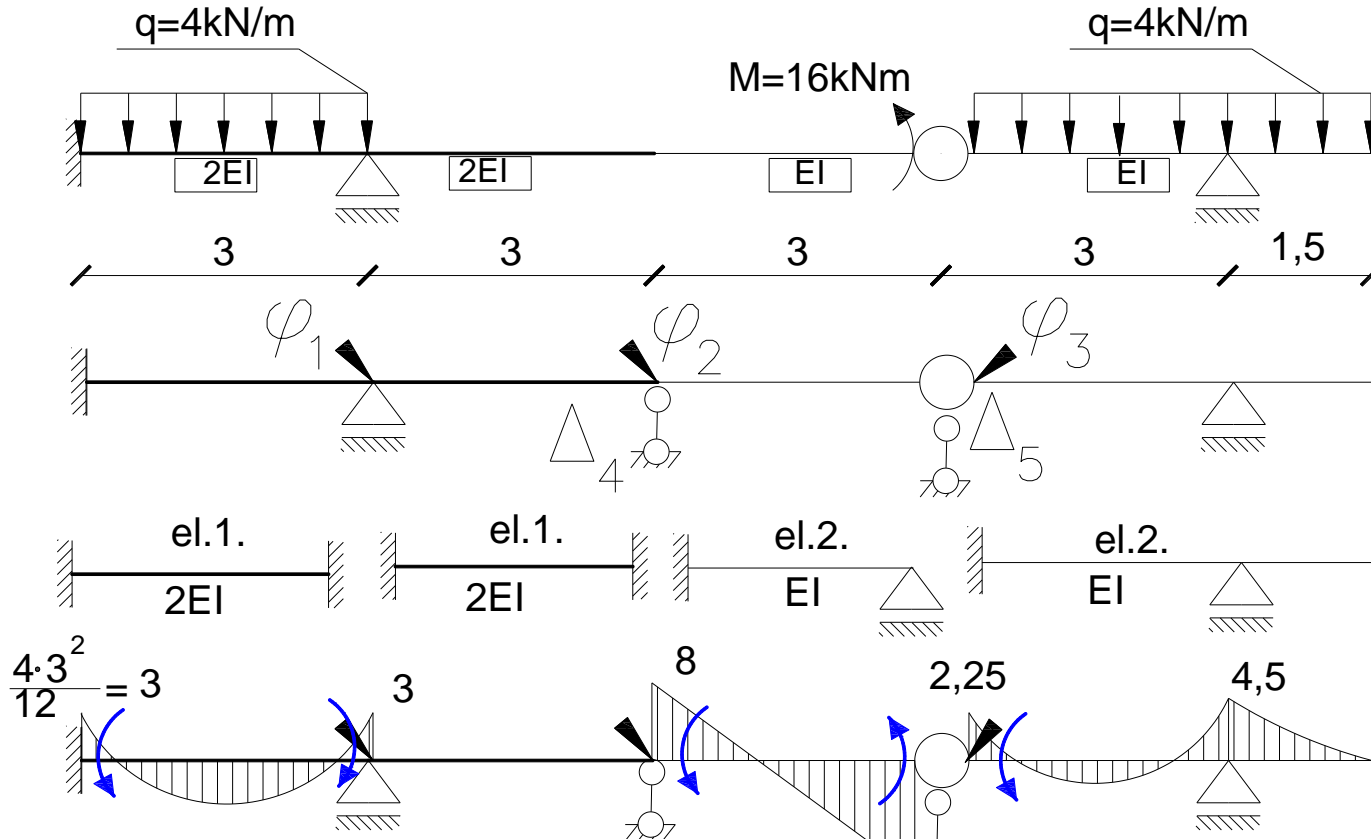

Obciążenie zewnętrzne

$$k_{10} = 3\text{kNm}$$

$$k_{20} = -8\text{kNm}$$

$$k_{30} = -2,25\text{kNm}$$

$$k_{40} = -8\text{kN}$$

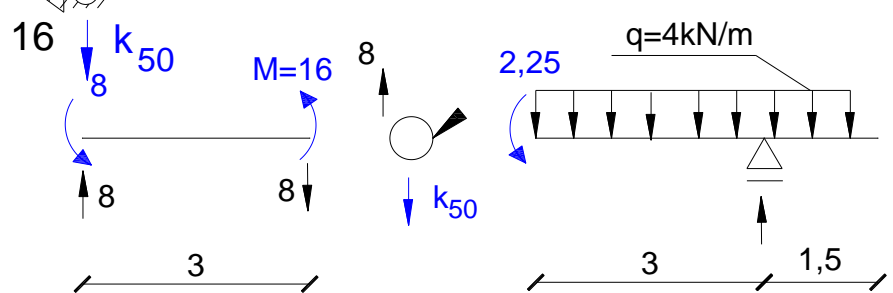

# Wykresy od obciążenia zewnętrznego

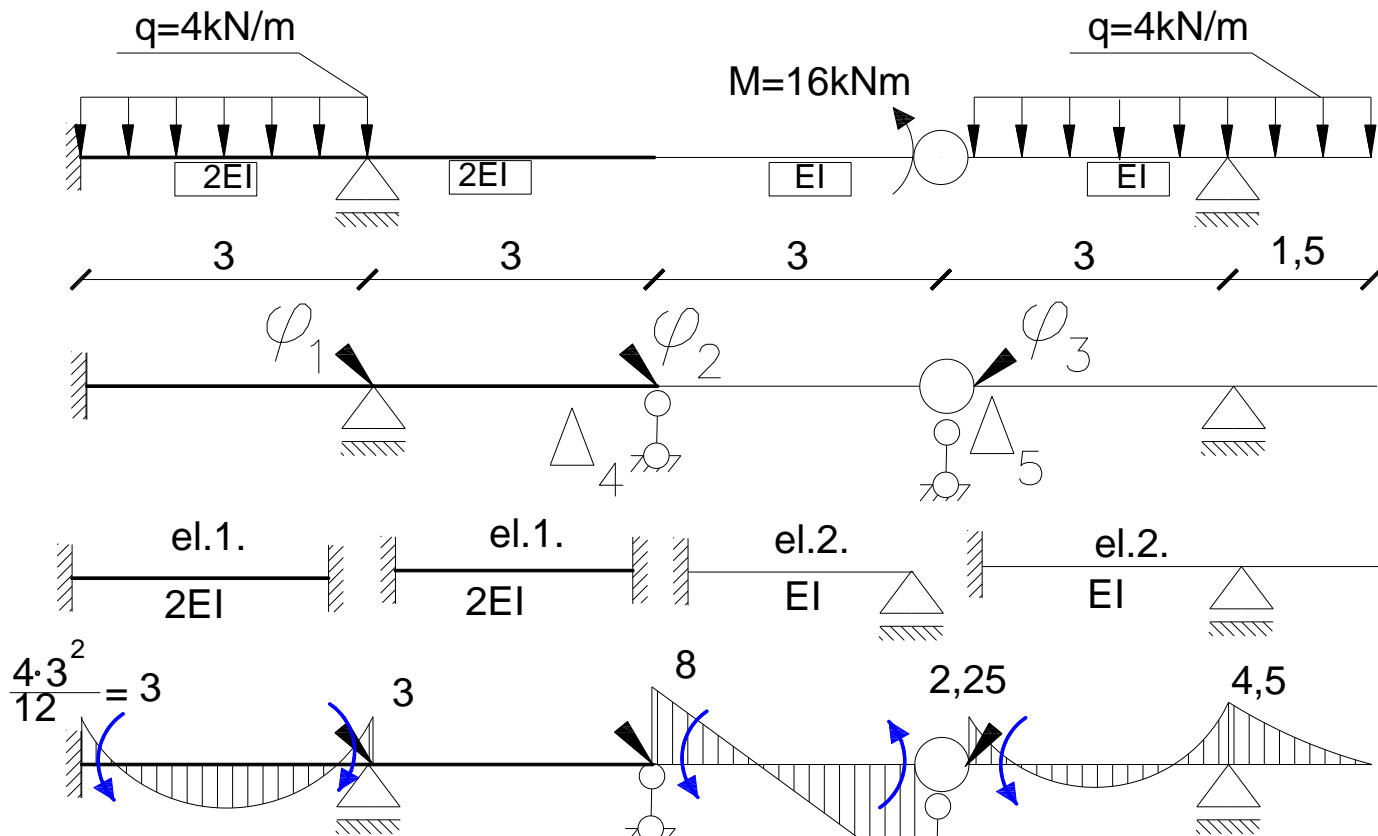

Obciążenie zewnętrzne

$k_{10} = 3\text{kNm}$   
 $k_{20} = -8\text{kNm}$   
 $k_{30} = -2,25\text{kNm}$   
 $k_{40} = -8\text{kN}$

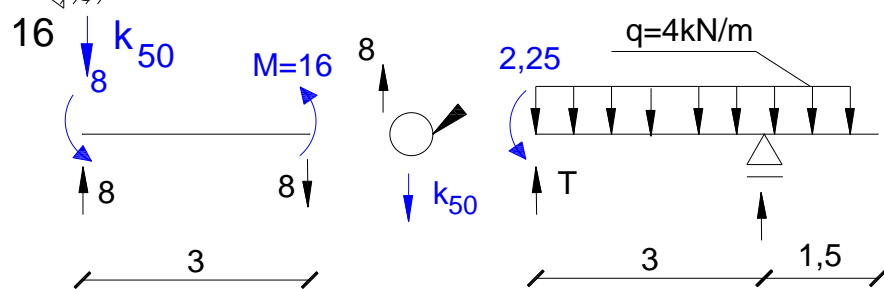

# Wykresy od obciążenia zewnętrznego

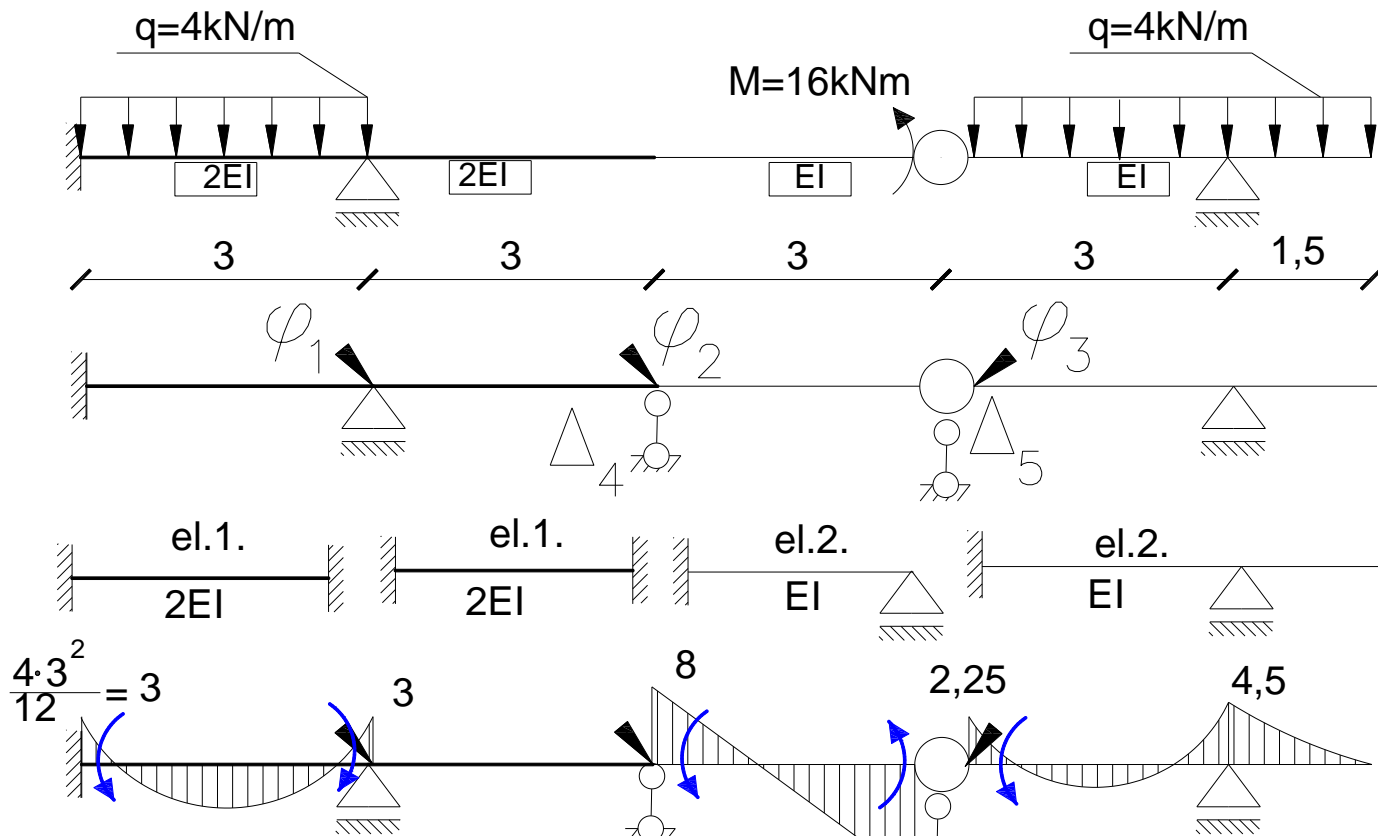

Obciążenie zewnętrzne

$$k_{10} = 3\text{kNm}$$

$$k_{20} = -8\text{kNm}$$

$$k_{30} = -2,25\text{kNm}$$

$$k_{40} = -8\text{kN}$$

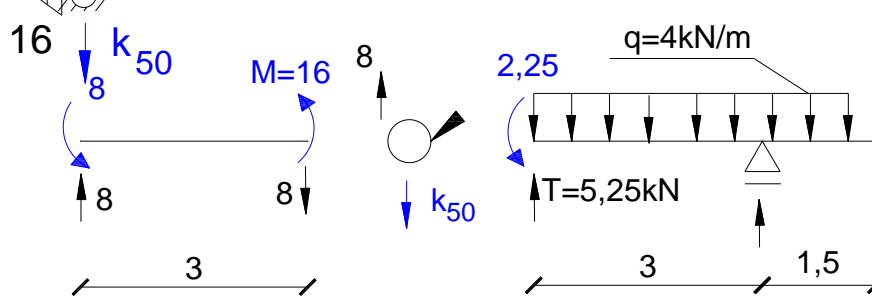

# Wykresy od obciążenia zewnętrznego

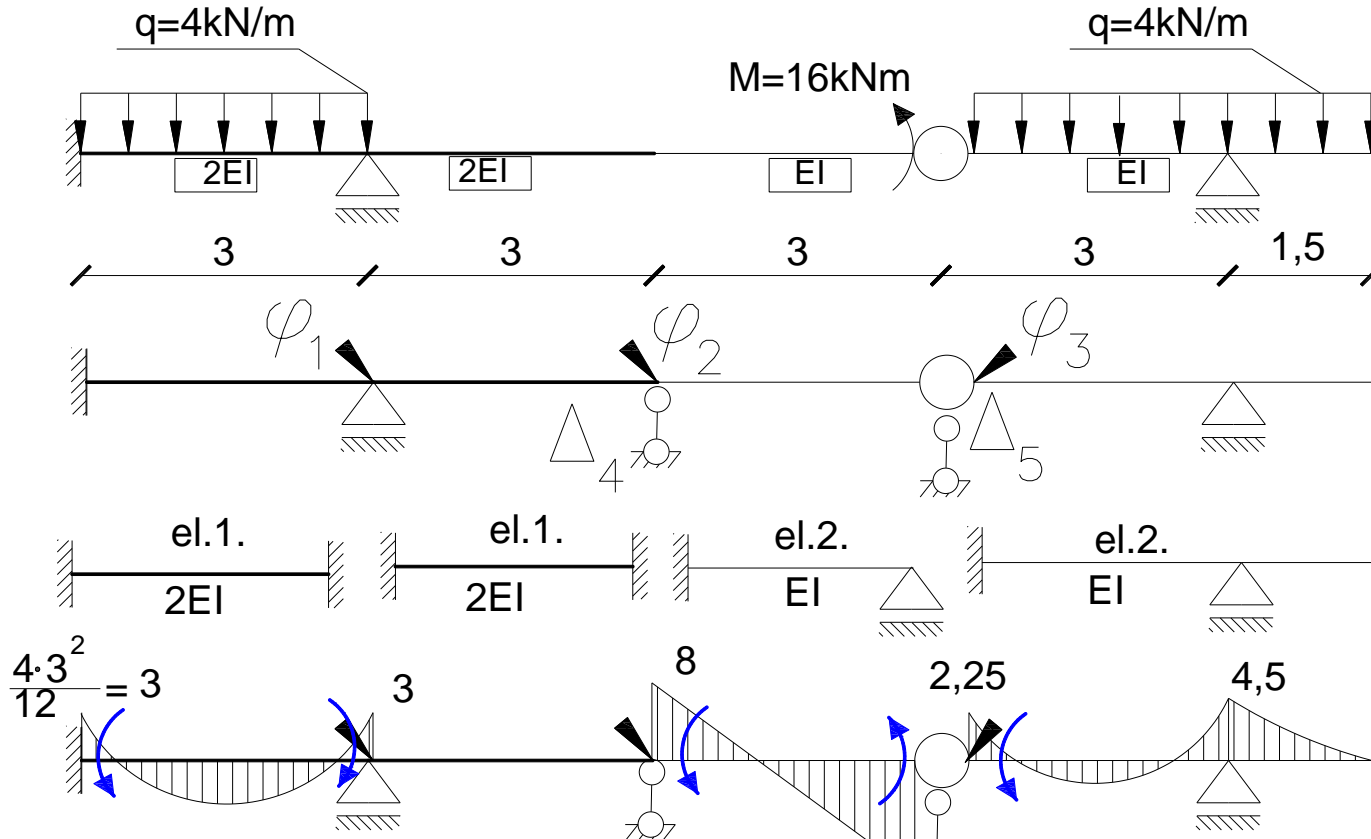

Obciążenie zewnętrzne

$$k_{10} = 3\text{ kNm}$$

$$k_{20} = -8\text{ kNm}$$

$$k_{30} = -2,25\text{ kNm}$$

$$k_{40} = -8\text{ kN}$$

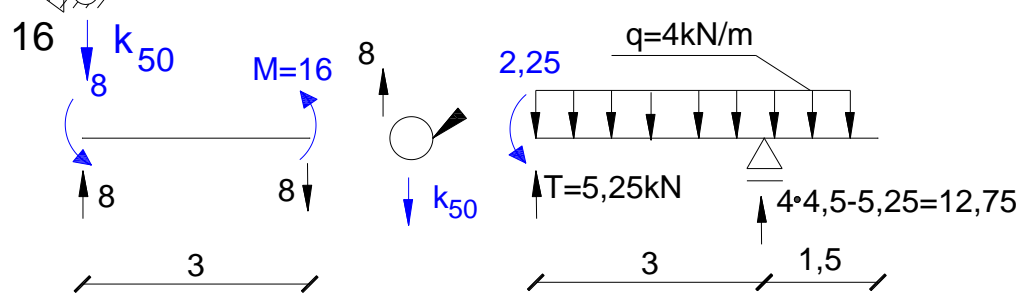

# Wykresy od obciążenia zewnętrznego

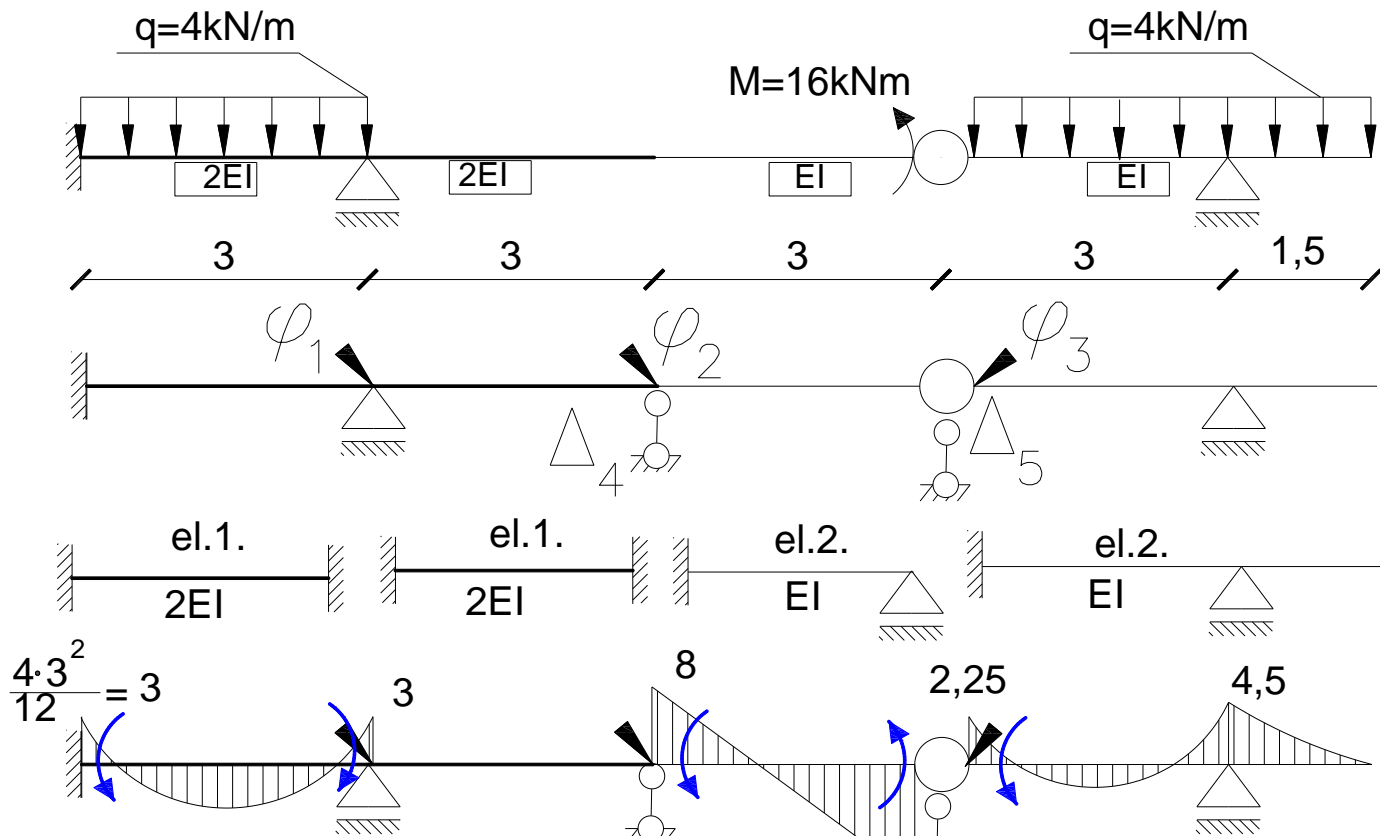

Obciążenie zewnętrzne

$$k_{10} = 3\text{kNm}$$

$$k_{20} = -8\text{kNm}$$

$$k_{30} = -2,25\text{kNm}$$

$$k_{40} = -8\text{kN}$$

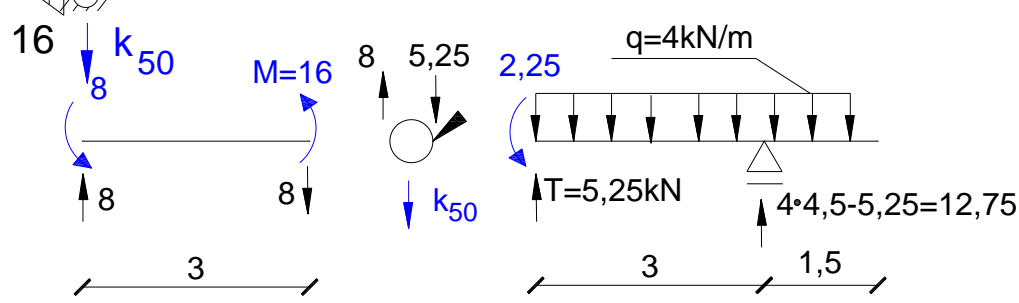

# Wykresy od obciążenia zewnętrznego

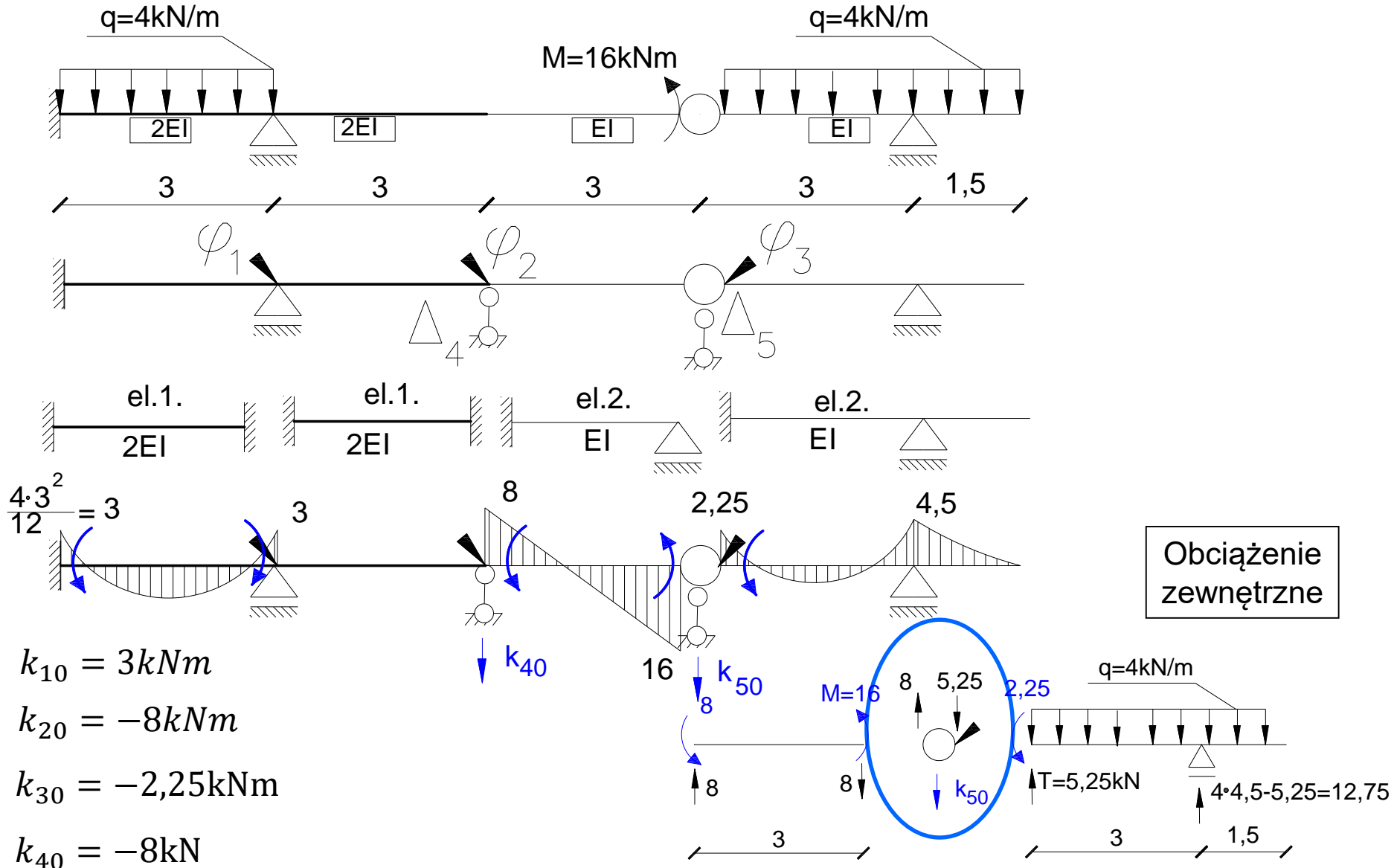

# Wykresy od obciążenia zewnętrznego

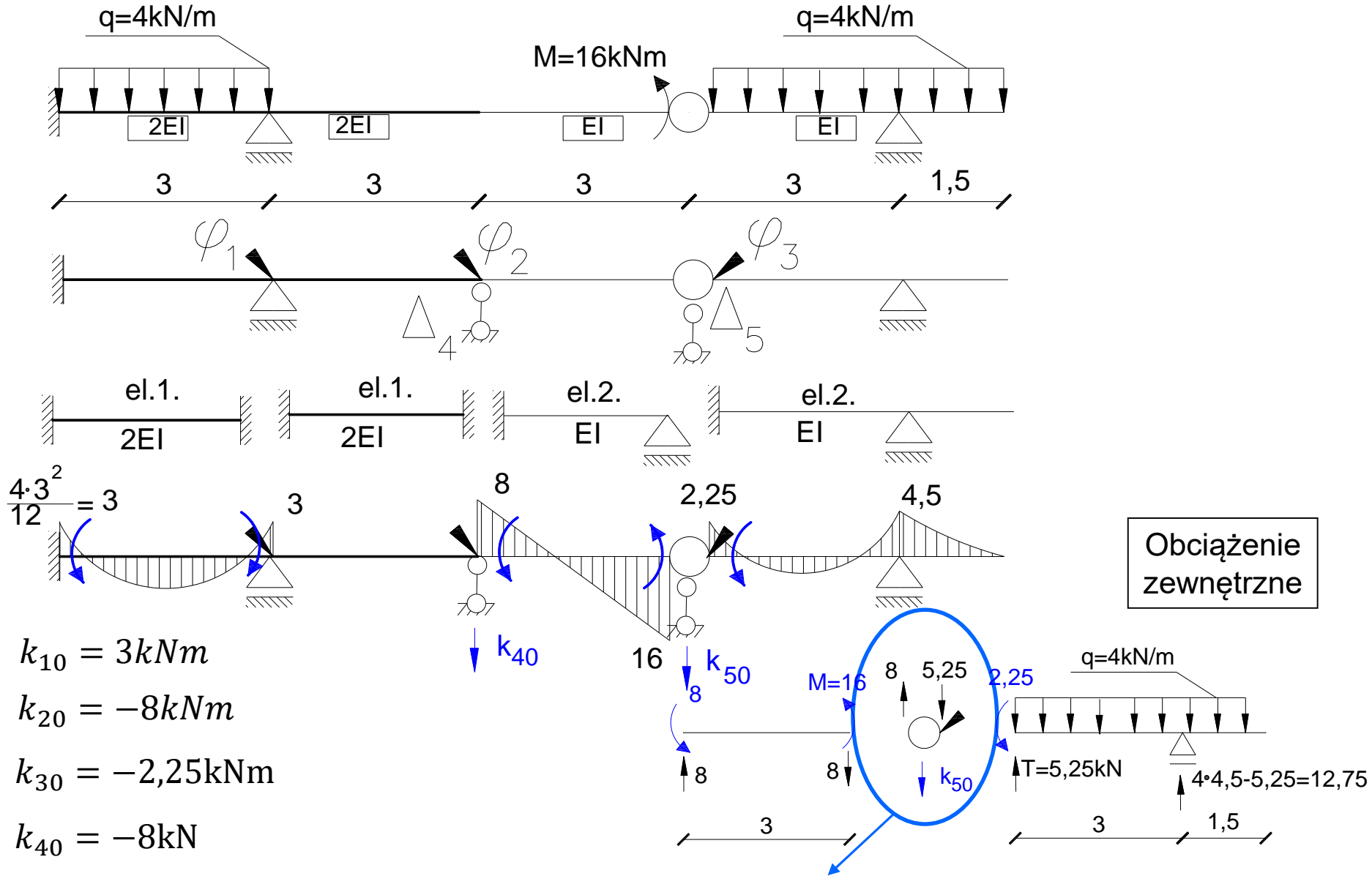

# Wykresy od obciążenia zewnętrznego

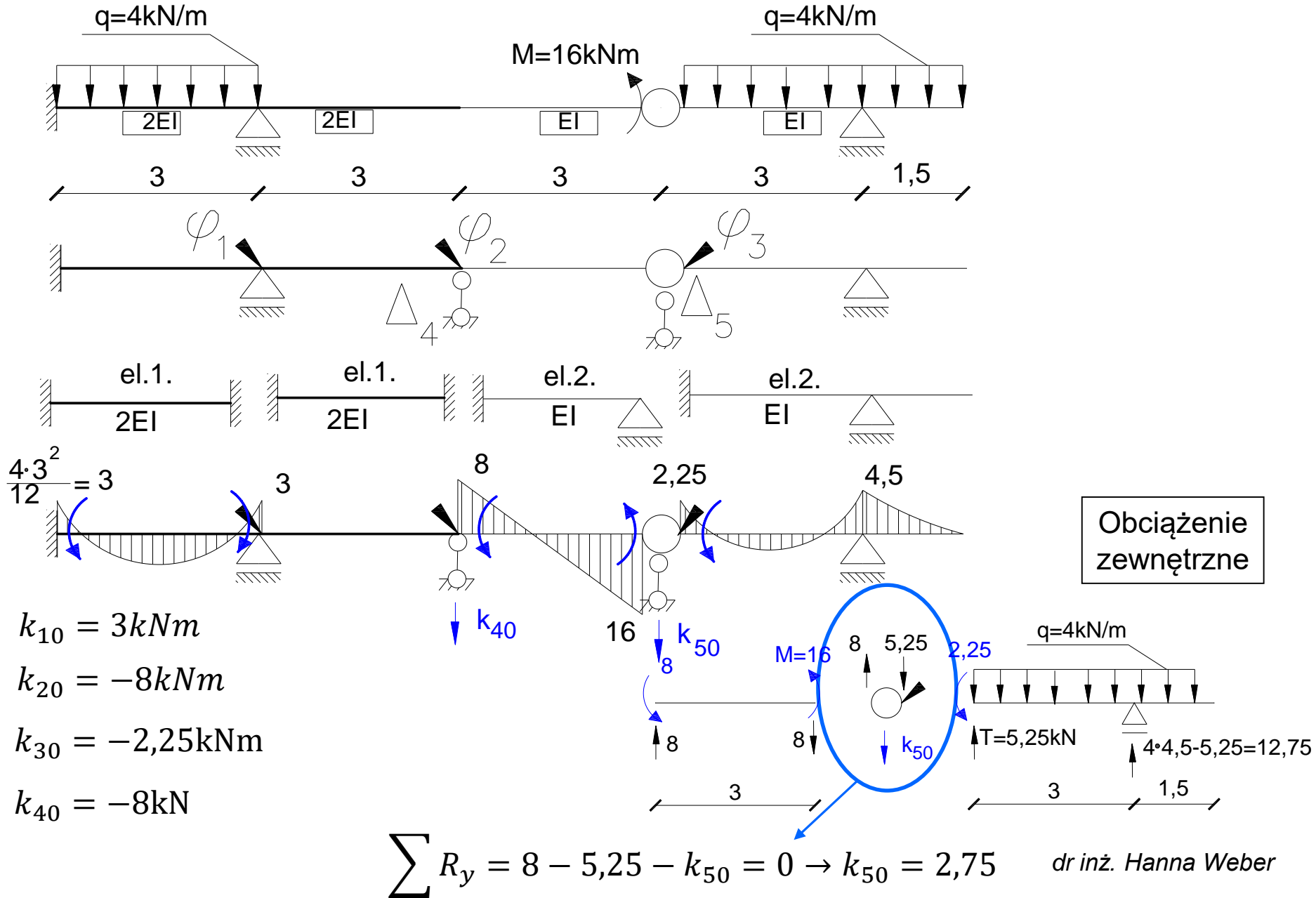



## Układ równań metody przemieszczeń:

$$k_{11} \cdot \varphi_1 + k_{12} \cdot \varphi_2 + k_{13} \cdot \varphi_3 + k_{14} \cdot \Delta_4 + k_{15} \cdot \Delta_5 + k_{10} = 0$$

$$k_{21} \cdot \varphi_1 + k_{22} \cdot \varphi_2 + k_{23} \cdot \varphi_3 + k_{24} \cdot \Delta_4 + k_{25} \cdot \Delta_5 + k_{20} = 0$$

$$k_{31} \cdot \varphi_1 + k_{32} \cdot \varphi_2 + k_{33} \cdot \varphi_3 + k_{34} \cdot \Delta_4 + k_{35} \cdot \Delta_5 + k_{30} = 0$$

$$k_{41} \cdot \varphi_1 + k_{42} \cdot \varphi_2 + k_{43} \cdot \varphi_3 + k_{44} \cdot \Delta_4 + k_{45} \cdot \Delta_5 + k_{40} = 0$$

$$k_{51} \cdot \varphi_1 + k_{52} \cdot \varphi_2 + k_{53} \cdot \varphi_3 + k_{54} \cdot \Delta_4 + k_{55} \cdot \Delta_5 + k_{50} = 0$$

$$\frac{16EI}{3} \cdot \varphi_1 + \frac{4EI}{3} \cdot \varphi_2 + 0 \cdot \varphi_3 - \frac{4EI}{3} \cdot \Delta_4 + 0 \cdot \Delta_5 + 3 = 0$$

$$\frac{4EI}{3} \cdot \varphi_1 + \frac{11EI}{3} \cdot \varphi_2 + 0 \cdot \varphi_3 - EI \cdot \Delta_4 - \frac{EI}{3} \cdot \Delta_5 - 8 = 0$$

$$0 \cdot \varphi_1 + 0 \cdot \varphi_2 + EI \cdot \varphi_3 + 0 \cdot \Delta_4 + \frac{EI}{3} \cdot \Delta_5 - 2,25 = 0$$

$$-\frac{4EI}{3} \cdot \varphi_1 - EI \cdot \varphi_2 + 0 \cdot \varphi_3 + EI \cdot \Delta_4 - \frac{EI}{9} \cdot \Delta_5 - 8 = 0$$

$$0 \cdot \varphi_1 - \frac{EI}{3} \cdot \varphi_2 + \frac{EI}{3} \cdot \varphi_3 - \frac{EI}{9} \cdot \Delta_4 + \frac{2EI}{9} \cdot \Delta_5 + 2,75 = 0$$

$$\varphi_1 = \frac{3}{EI}$$

$$\varphi_2 = \frac{9,375}{EI}$$

$$\varphi_3 = \frac{-4,5}{EI}$$

$$\Delta_4 = \frac{23,625}{EI}$$

$$\Delta_5 = \frac{20,25}{EI}$$