

**Zadanie:** Narysuj wykres sił normalnych dla zadanej kratownicy i policz przemieszczenie pionowe węzła B. Zadanie rozwiąż metodą sił.

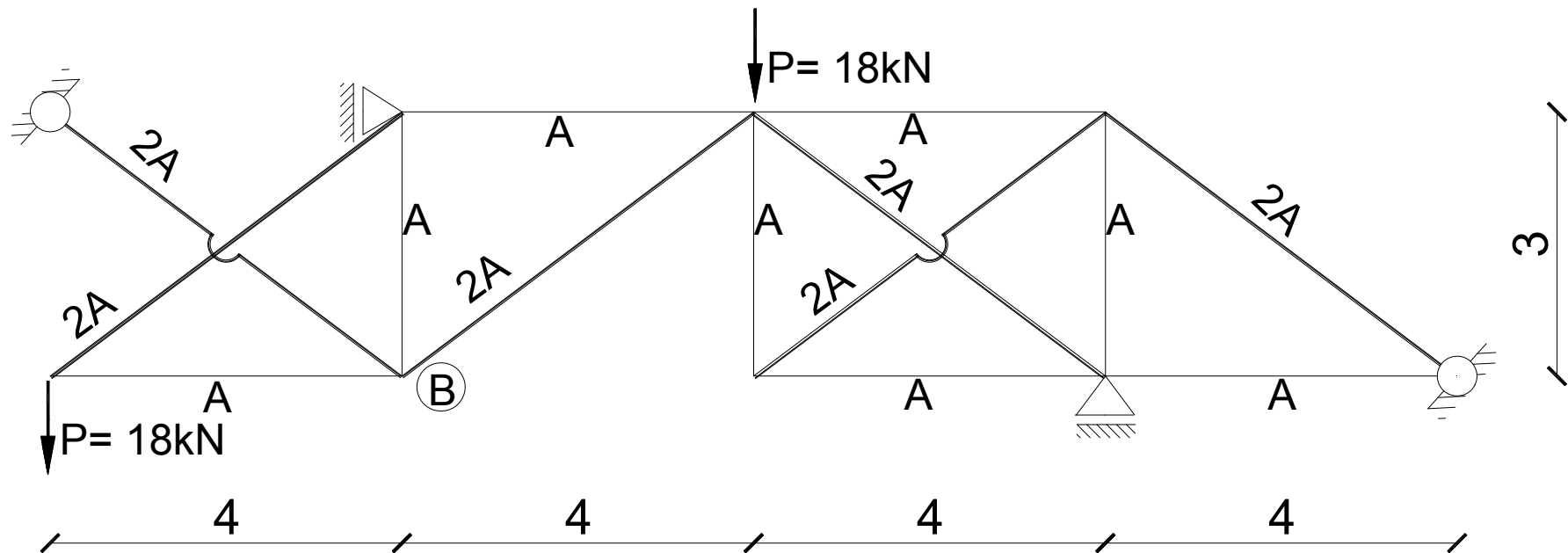

## Oznaczenie prętów:

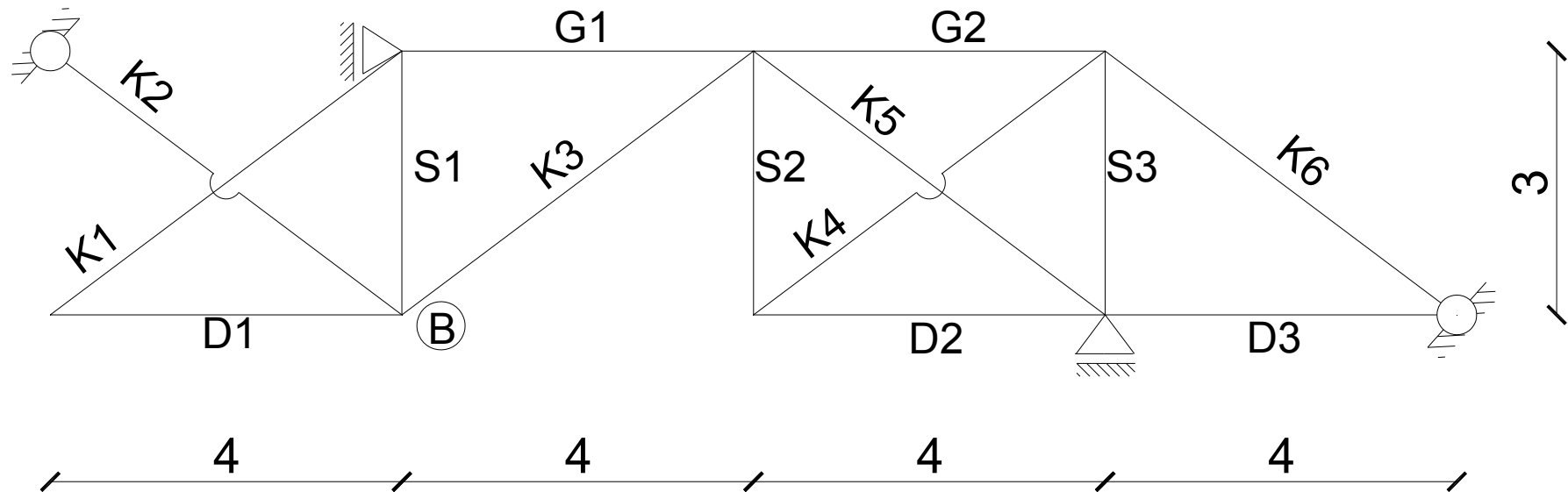

Stopień statycznej niewyznaczalności:

$$n_s = l_r + l_{pr} - 2 \cdot w = 6 + 14 - 2 \cdot 9 = 2$$

## Dobór schematu podstawowego:

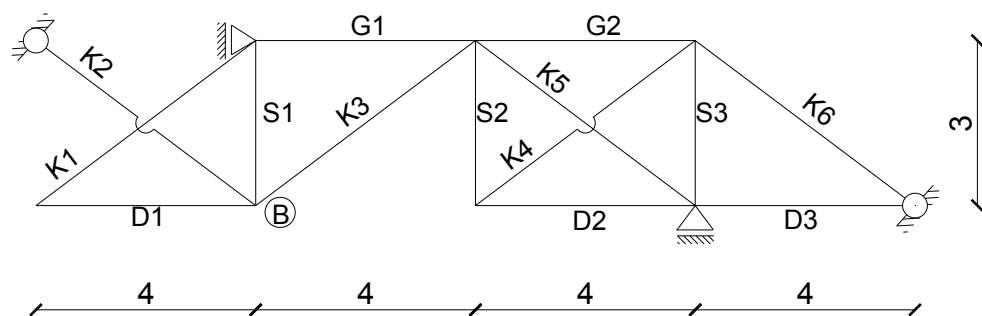
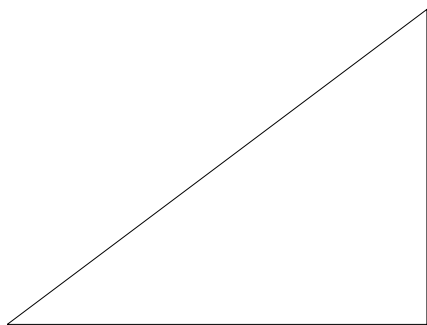

## Dobór schematu podstawowego:

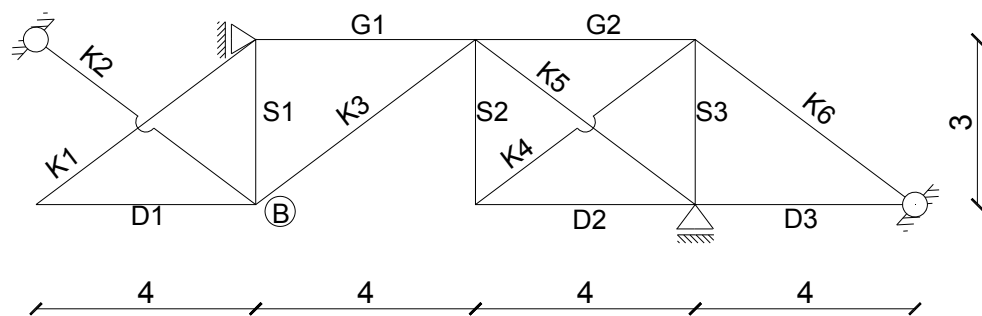
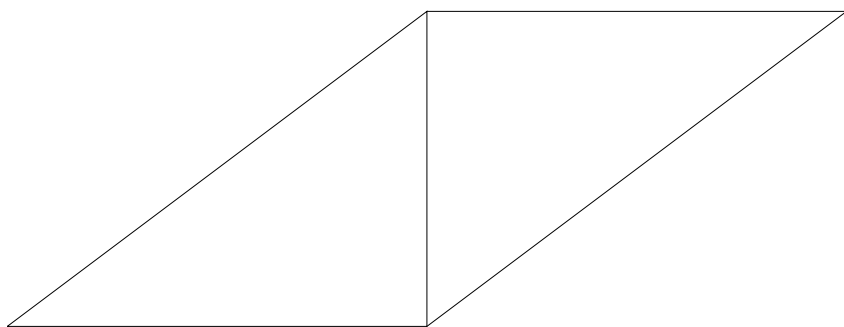

## Dobór schematu podstawowego:

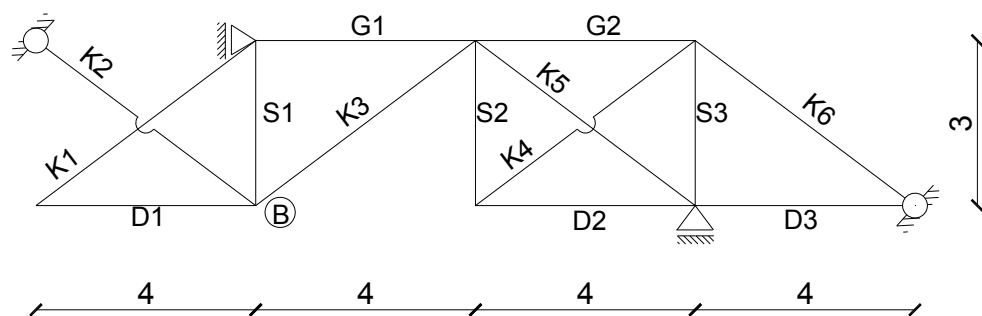
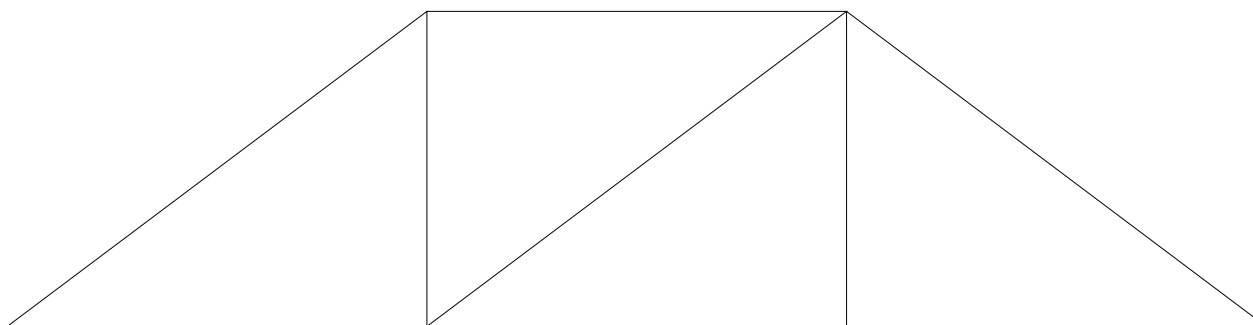

## Dobór schematu podstawowego:

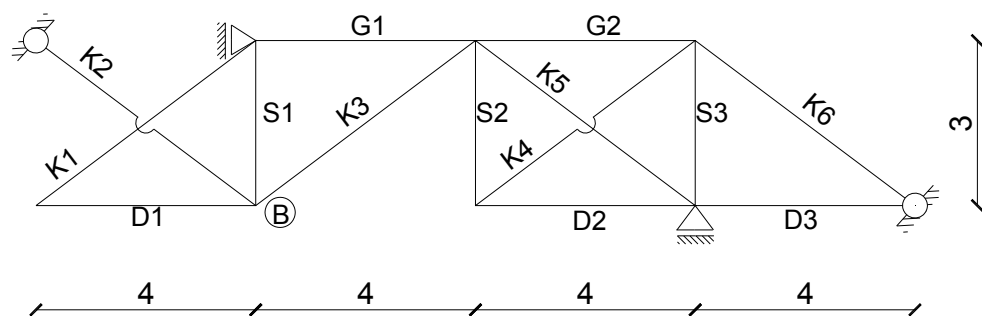
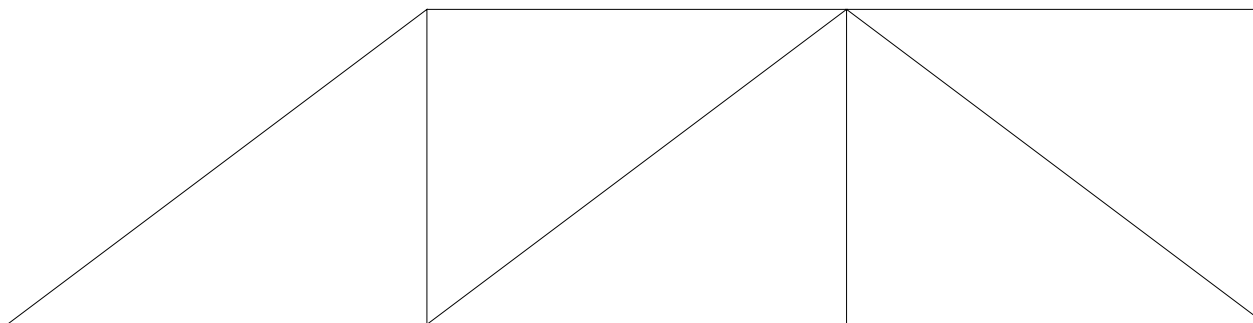

## Dobór schematu podstawowego:

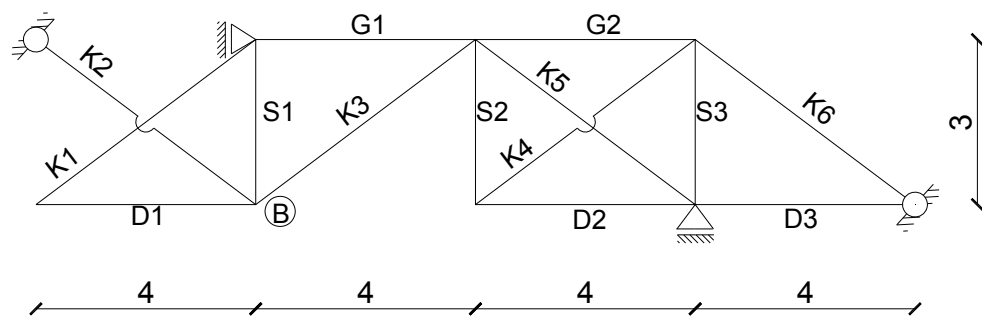
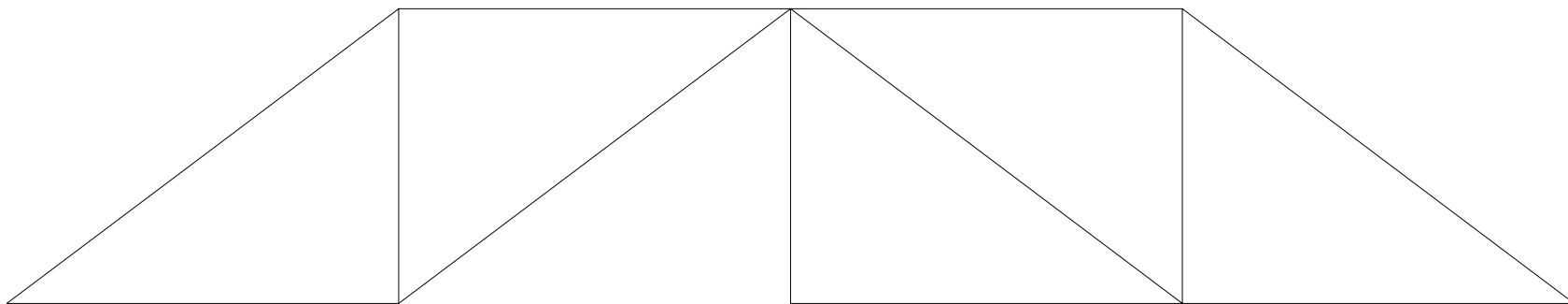

## Dobór schematu podstawowego:

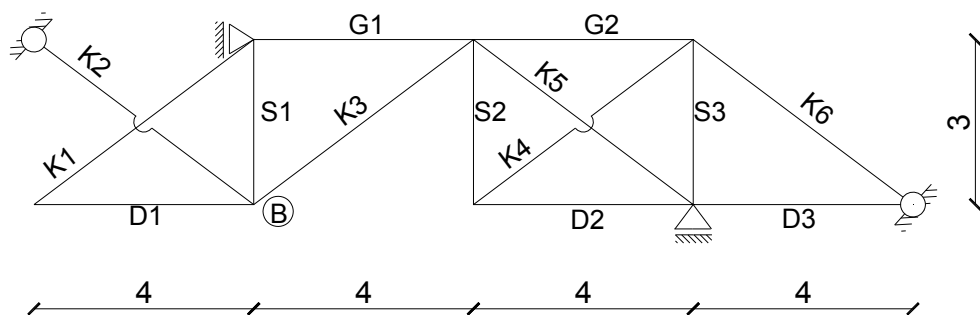
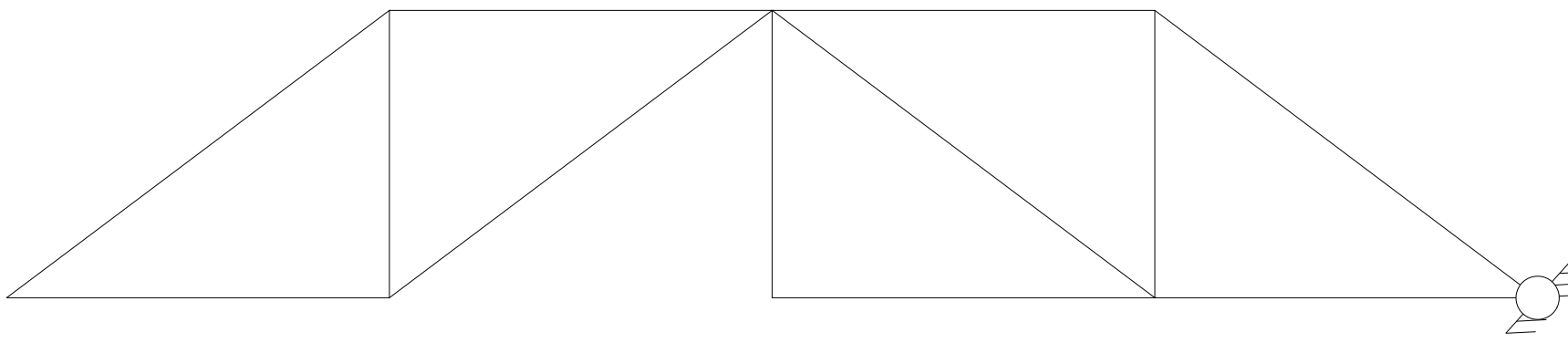



## Dobór schematu podstawowego:

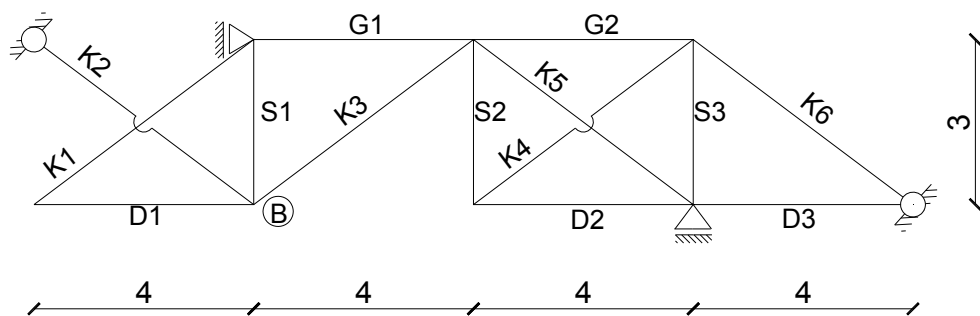
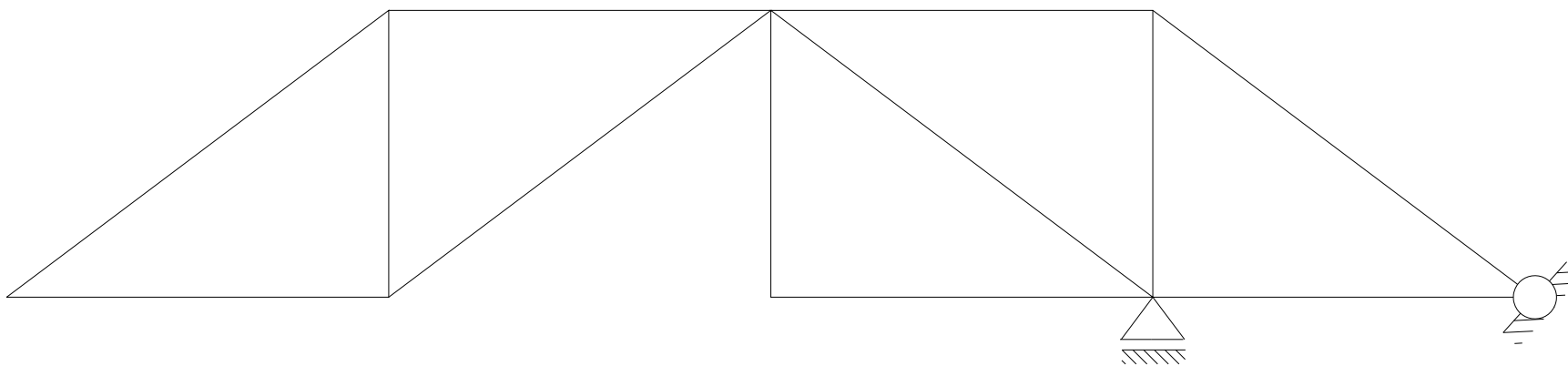

## Dobór schematu podstawowego:

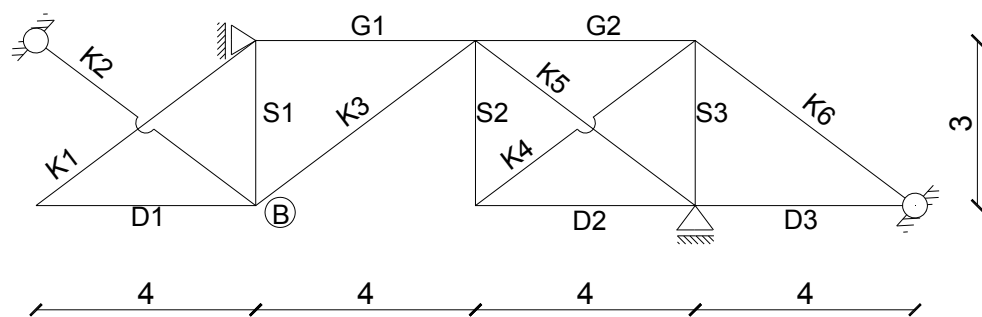
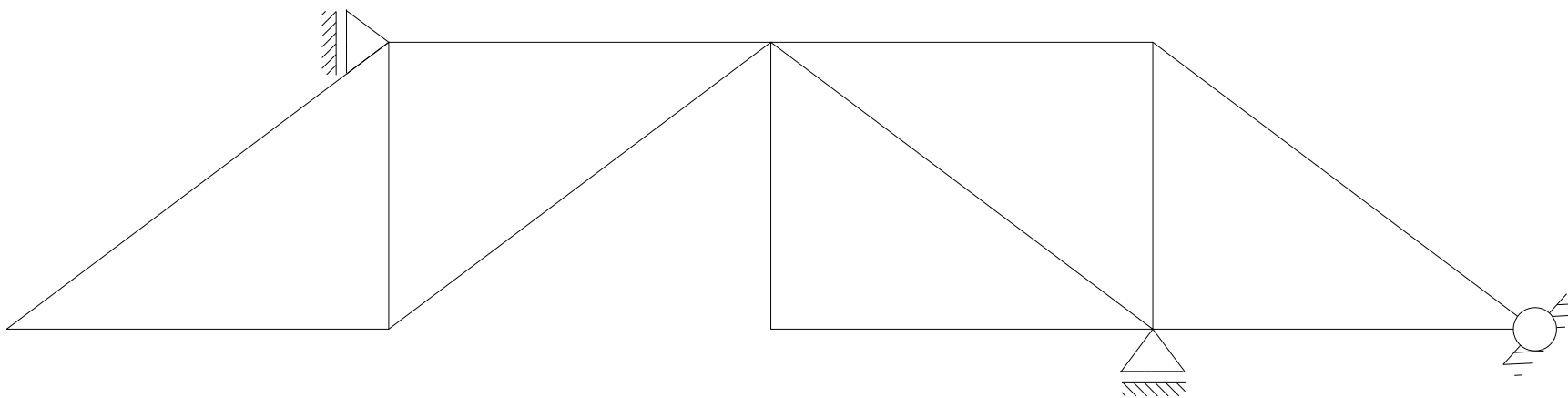

## Dobór schematu podstawowego:

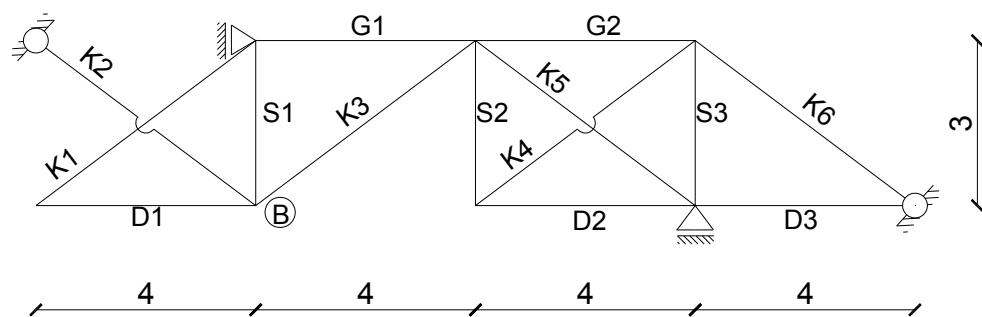
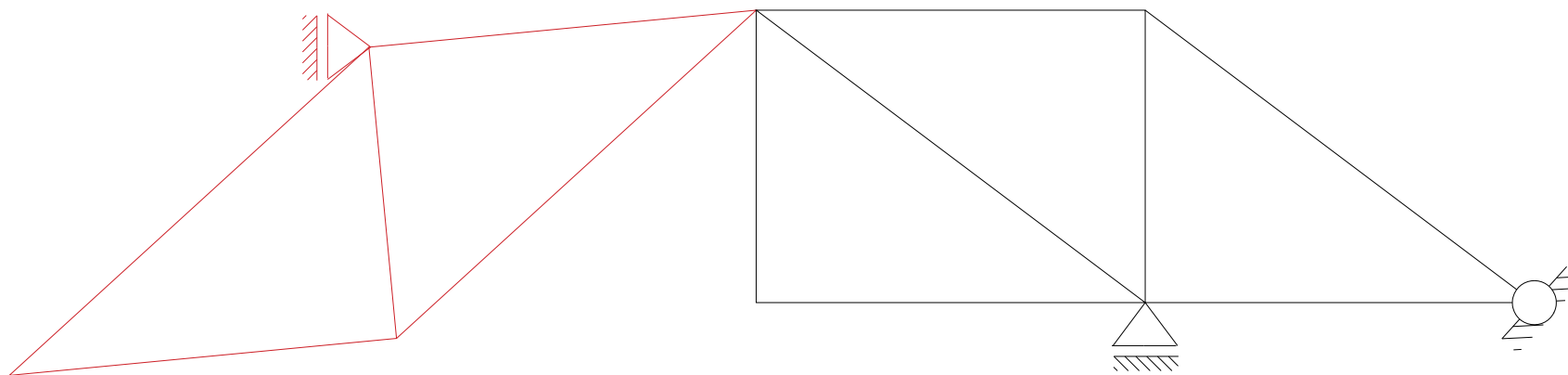

## Dobór schematu podstawowego:

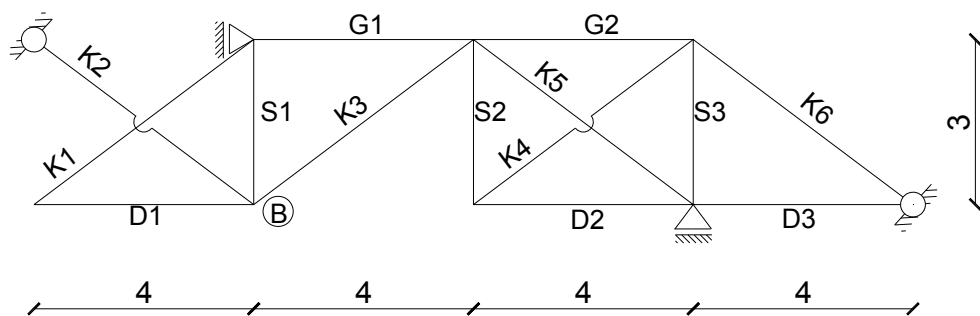
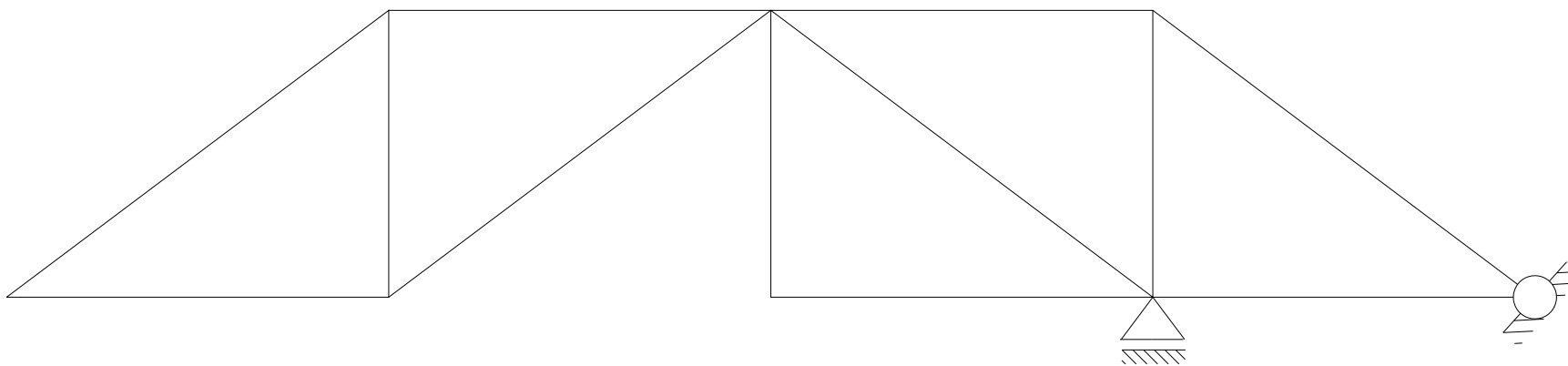

## Dobór schematu podstawowego:

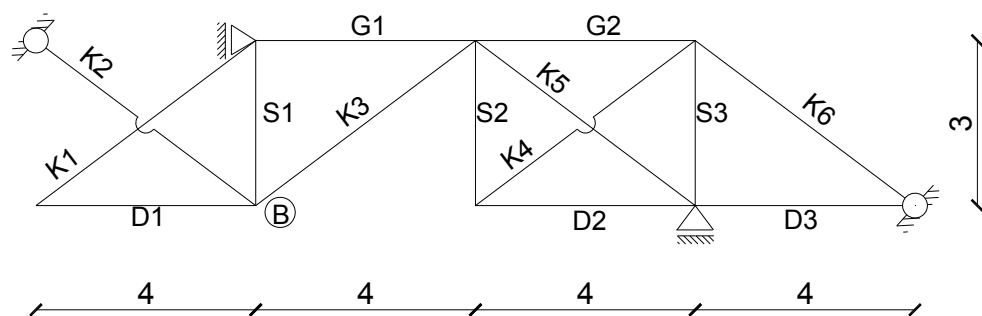
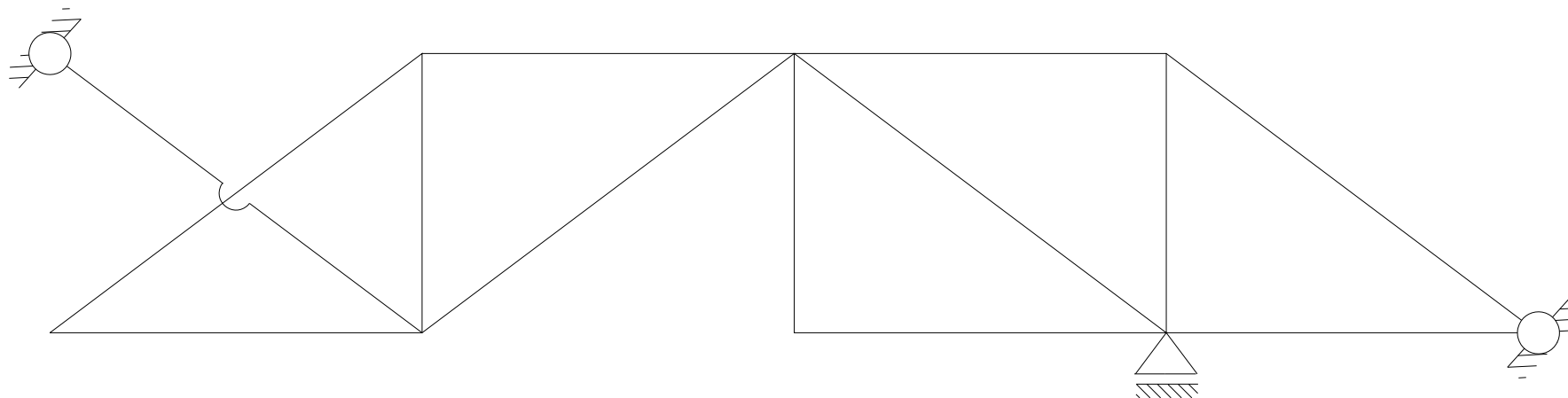

## Dobór schematu podstawowego:

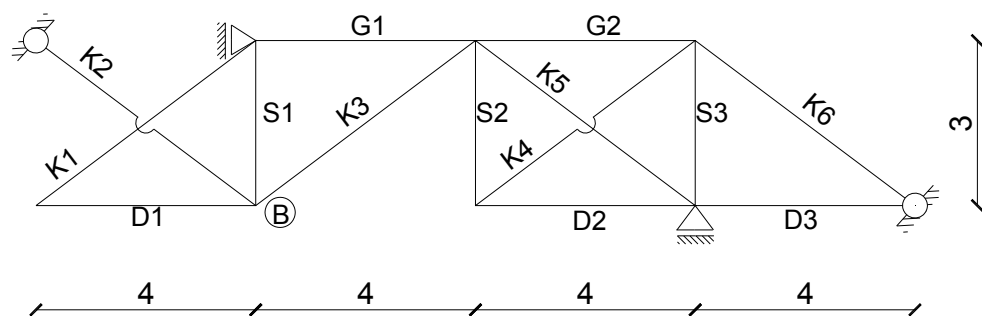
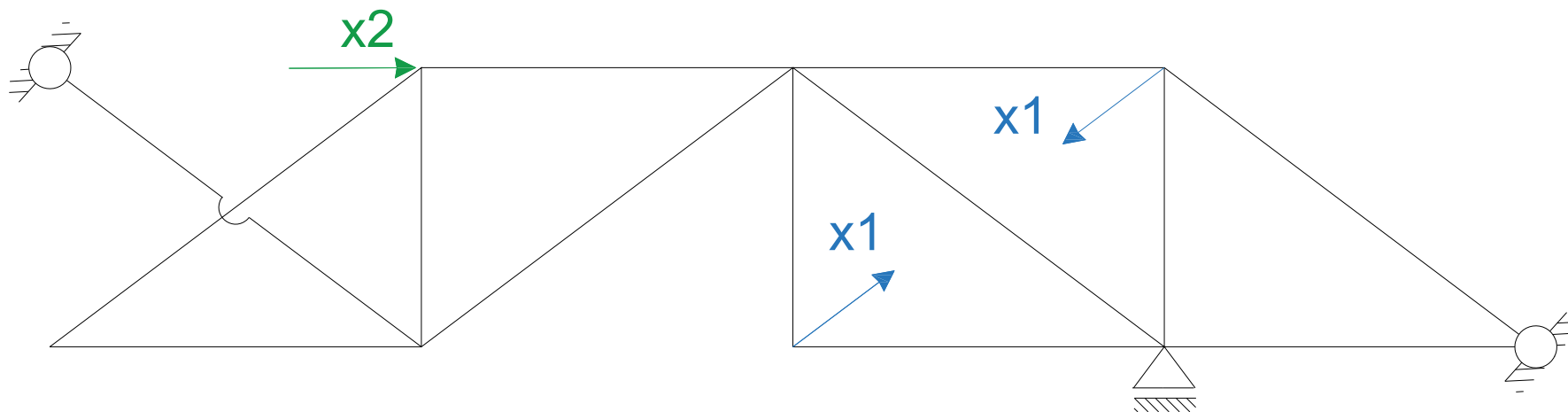

# Wykresy: stan $x_1=1$ , siły N1

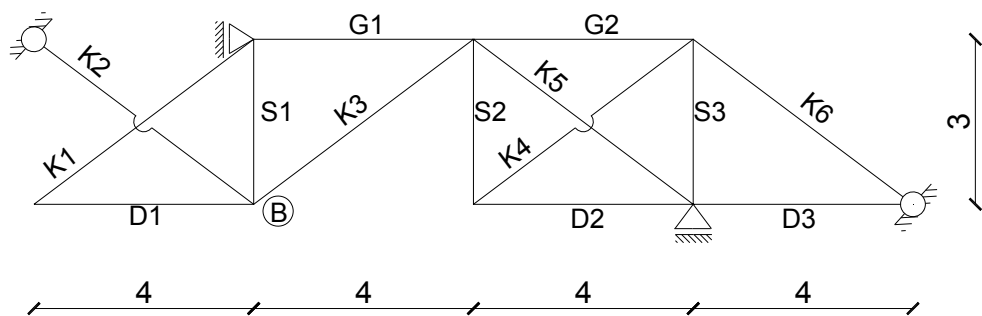
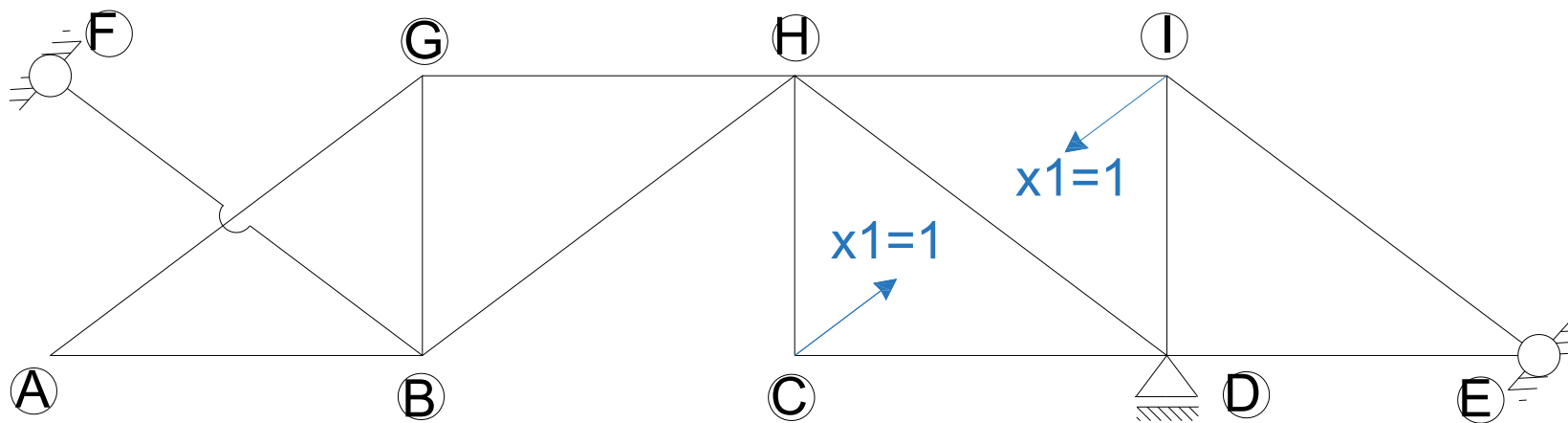

# Wykresy: stan $x_1=1$ , siły N1

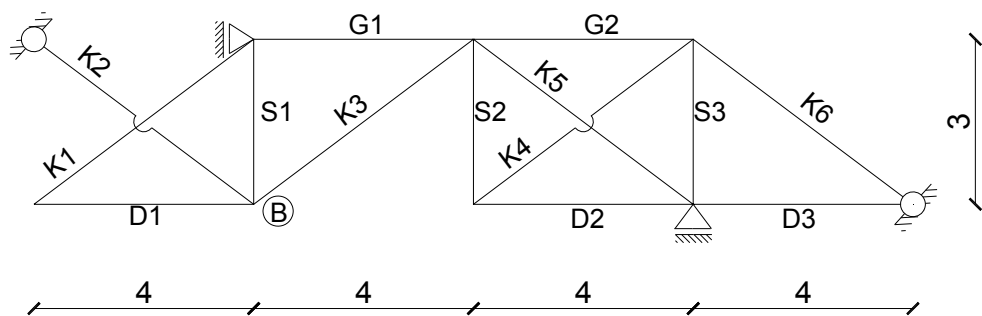
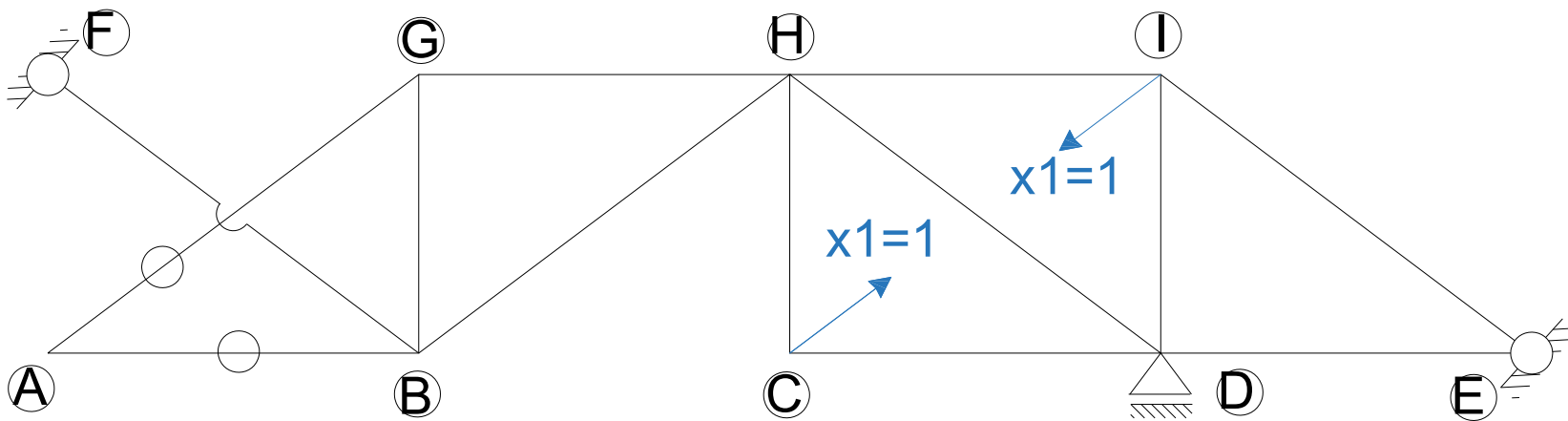



# Wykresy: stan $x_1=1$ , siły N1

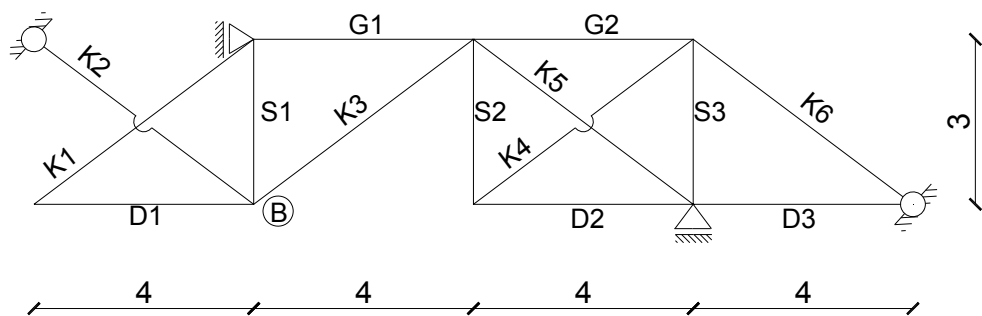
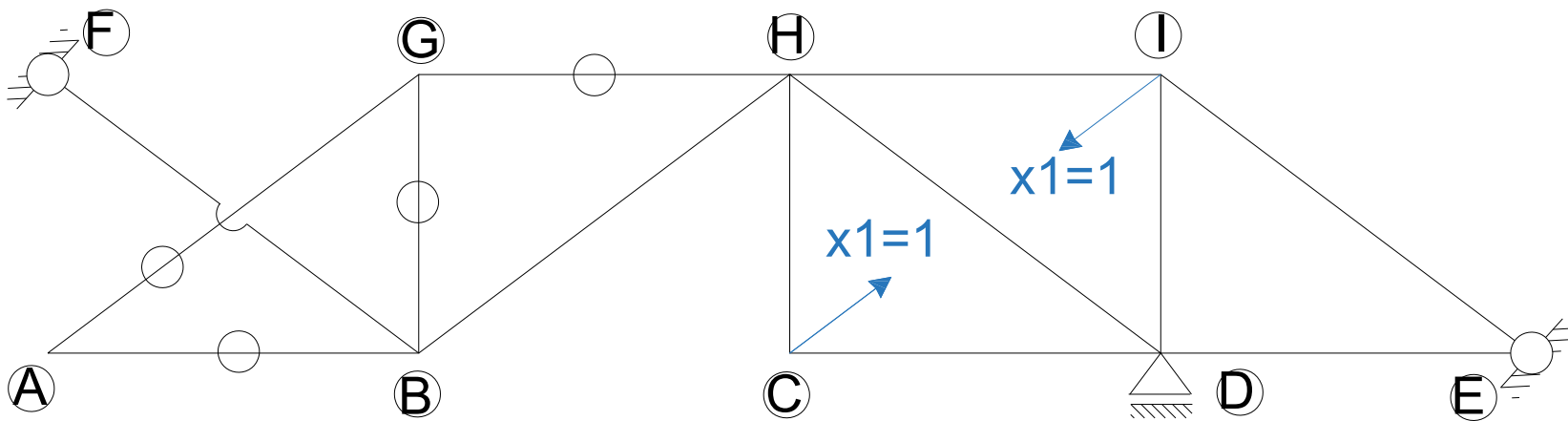

# Wykresy: stan $x_1=1$ , siły N1

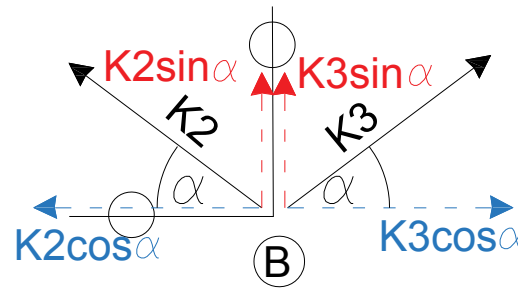
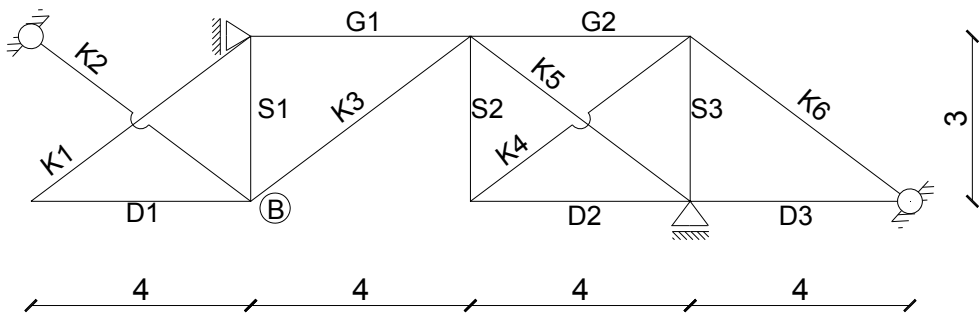
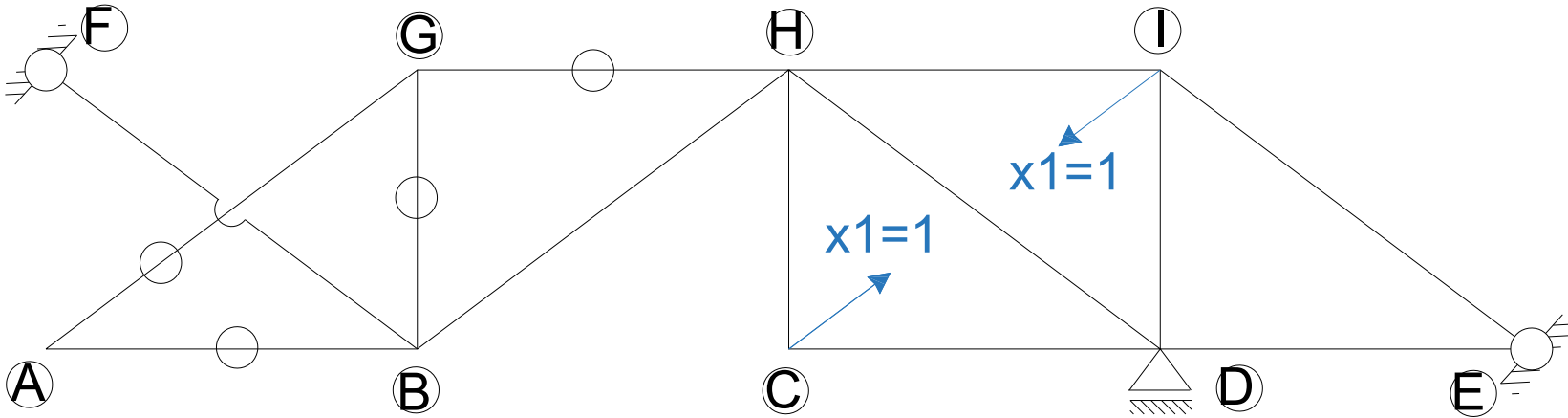

$$\sum R_y = K_2 \sin \alpha + K_3 \sin \alpha = 0$$



$$K_2 = -K_3$$

$$\sum R_x = -K_2 \cos \alpha + K_3 \cos \alpha = 0$$

$$-(-K_3) \cos \alpha + K_3 \cos \alpha = 0$$

$$2 \cdot K_3 \cos \alpha = 0$$

$$K_3 = 0$$

# Wykresy: stan $x_1=1$ , siły N1

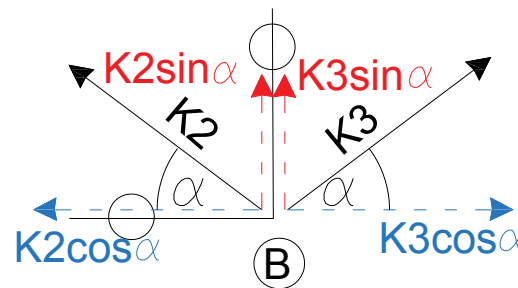
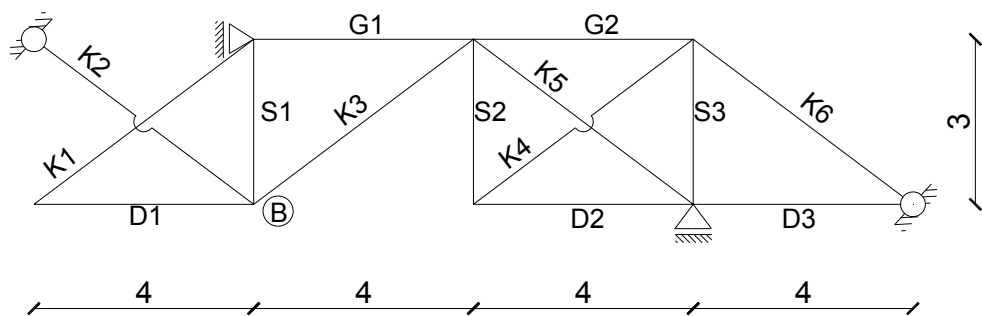
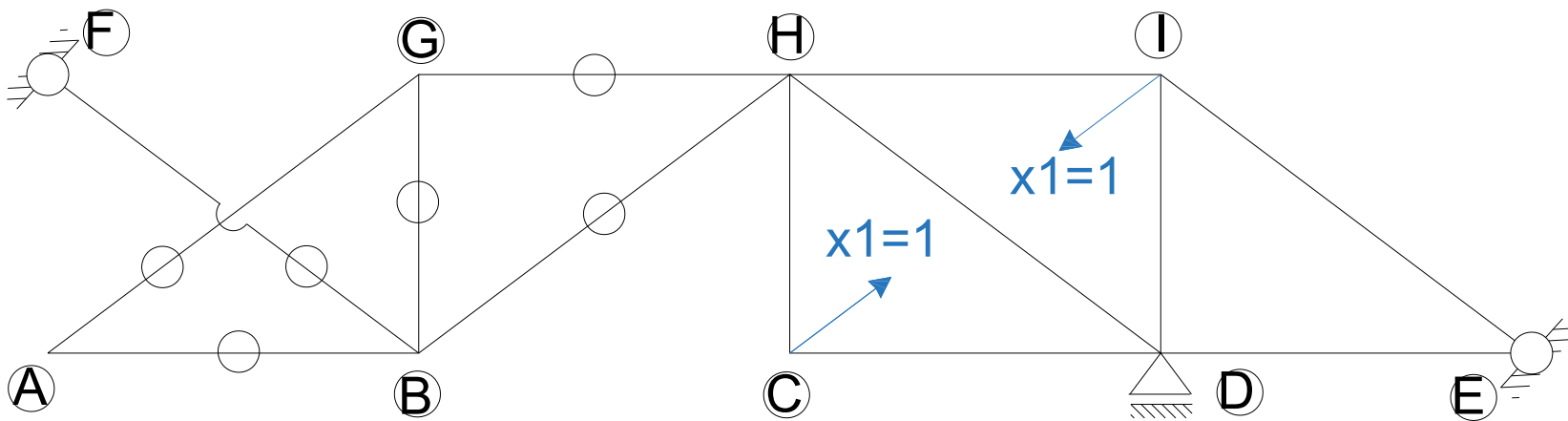

$$\sum R_y = K_2 \sin \alpha + K_3 \sin \alpha = 0$$

↓

$$K_2 = -K_3$$

$$\sum R_x = -K_2 \cos \alpha + K_3 \cos \alpha = 0$$

$$-(-K_3) \cos \alpha + K_3 \cos \alpha = 0$$

$$2 \cdot K_3 \cos \alpha = 0$$

$$K_3 = 0$$

# Wykresy: stan $x_1=1$ , siły N1

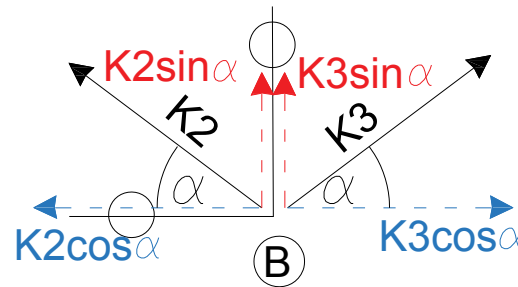
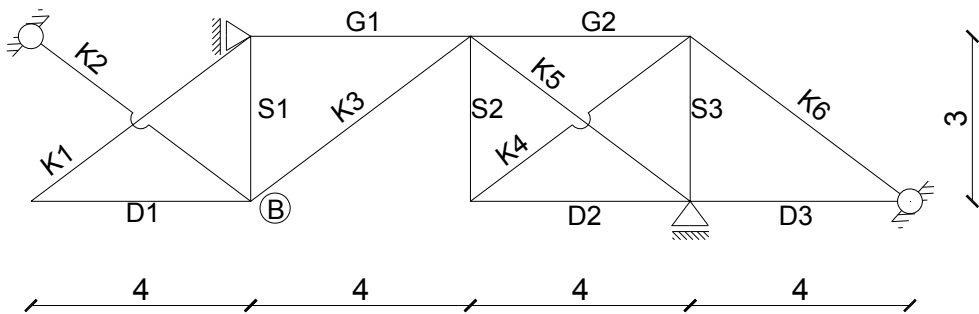
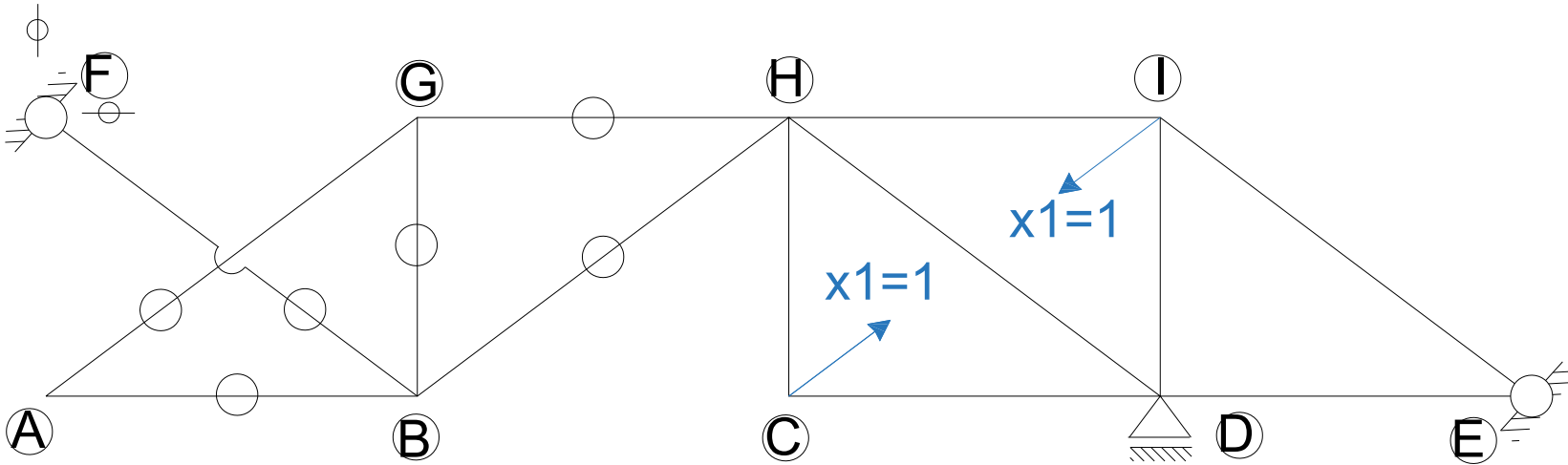

$$\sum R_y = K_2 \sin \alpha + K_3 \sin \alpha = 0$$



$$K_2 = -K_3$$

$$\sum R_x = -K_2 \cos \alpha + K_3 \cos \alpha = 0$$

$$-(-K_3) \cos \alpha + K_3 \cos \alpha = 0$$

$$2 \cdot K_3 \cos \alpha = 0$$

$$K_3 = 0$$

# Wykresy: stan $x_1=1$ , siły N1

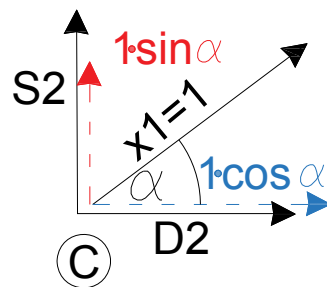
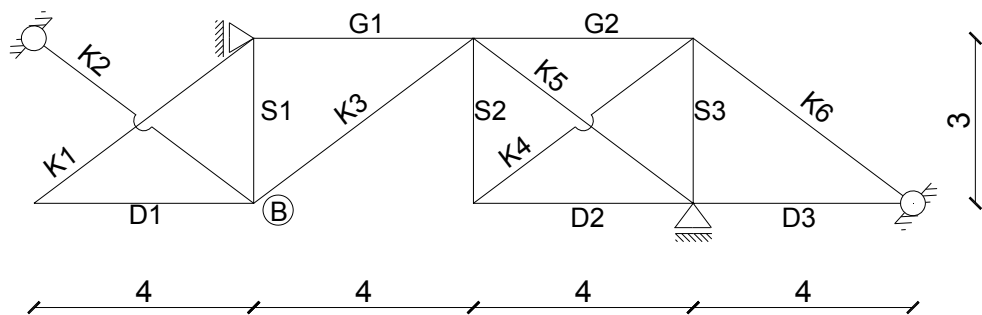
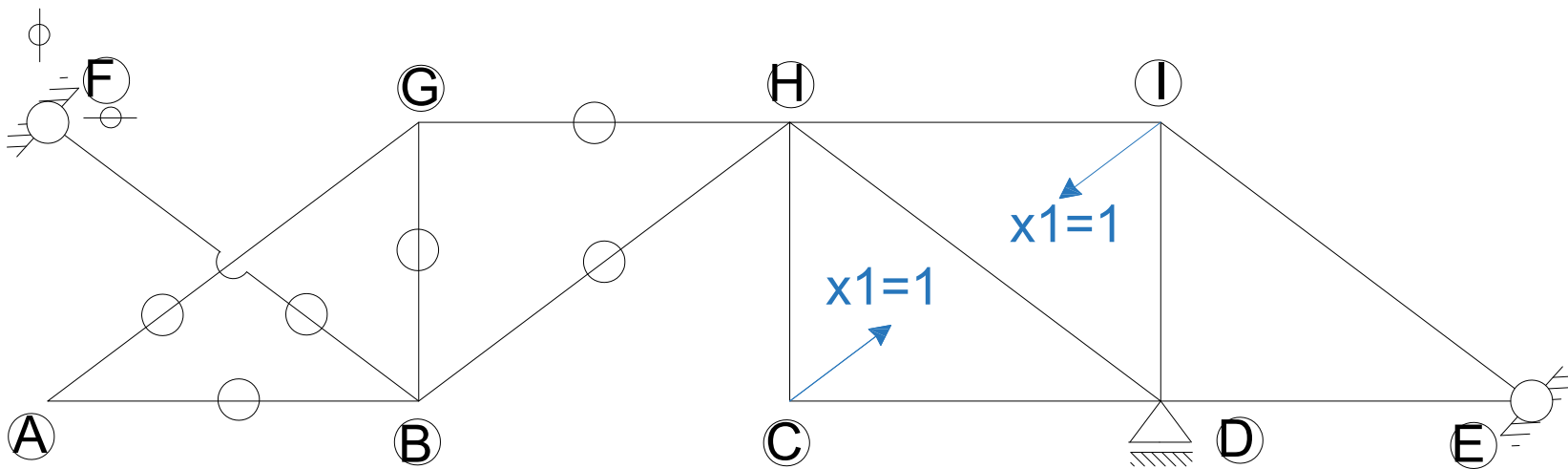

$$\sum R_y = S2 + x1 \cdot \sin \alpha = 0$$



$$S2 = -x1 \cdot \sin \alpha = -1 \cdot \frac{3}{5} = -0,6$$

$$\sum R_x = D2 + x1 \cdot \cos \alpha = 0$$



$$D2 = -x1 \cdot \cos \alpha = -1 \cdot \frac{4}{5} = -0,8$$

# Wykresy: stan $x_1=1$ , siły N1

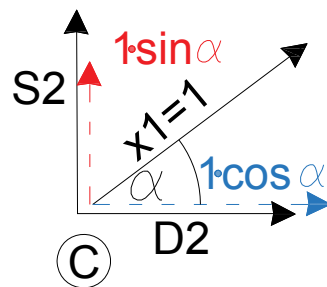
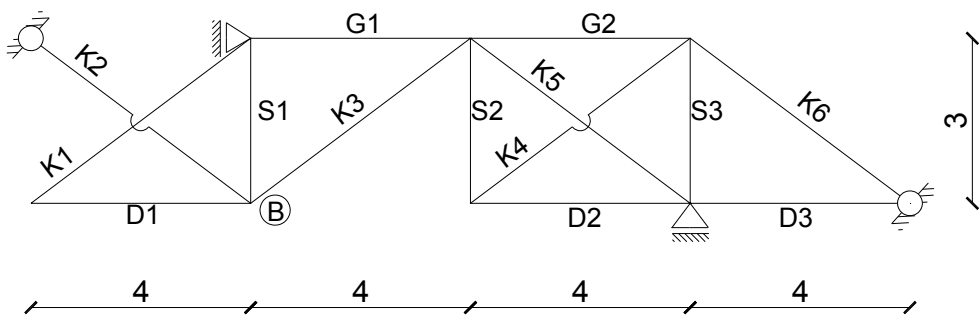
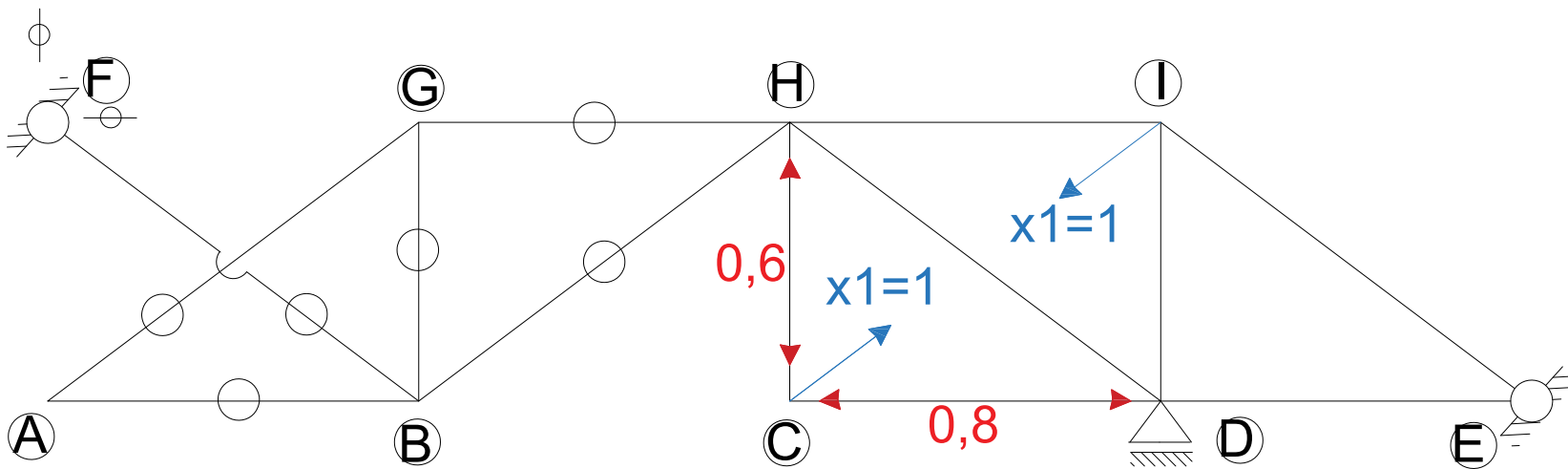

$$\sum R_y = S_2 + x_1 \cdot \sin \alpha = 0$$

$$\downarrow$$

$$S_2 = -x_1 \cdot \sin \alpha = -1 \cdot \frac{3}{5} = -0,6$$

$$\sum R_x = D_2 + x_1 \cdot \cos \alpha = 0$$

$$\downarrow$$

$$D_2 = -x_1 \cdot \cos \alpha = -1 \cdot \frac{4}{5} = -0,8$$

# Wykresy: stan $x_1=1$ , siły N1

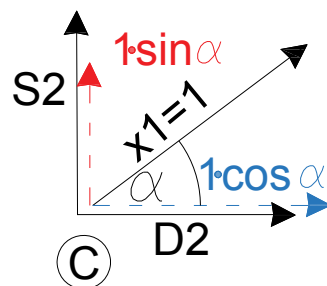
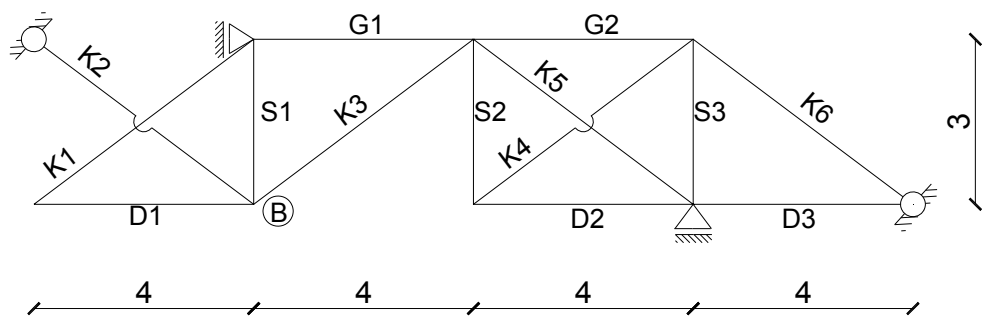
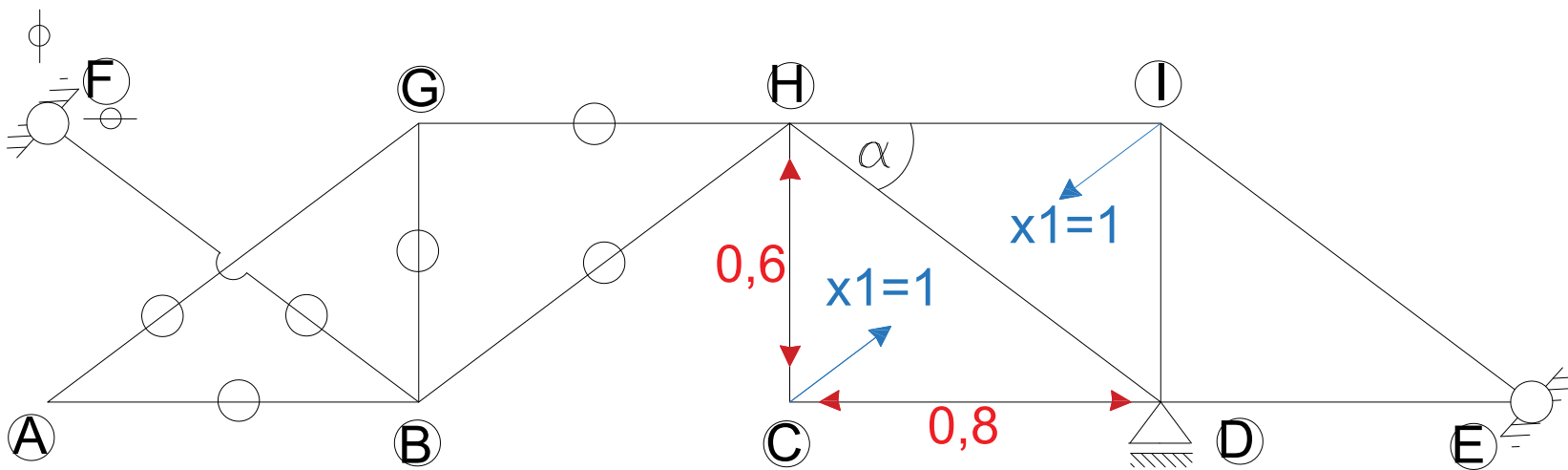

$$\sum R_y = S2 + x1 \cdot \sin \alpha = 0$$

$$\downarrow$$

$$S2 = -x1 \cdot \sin \alpha = -1 \cdot \frac{3}{5} = -0,6$$

$$\sum R_x = D2 + x1 \cdot \cos \alpha = 0$$

$$\downarrow$$

$$D2 = -x1 \cdot \cos \alpha = -1 \cdot \frac{4}{5} = -0,8$$

# Wykresy: stan $x_1=1$ , siły N1

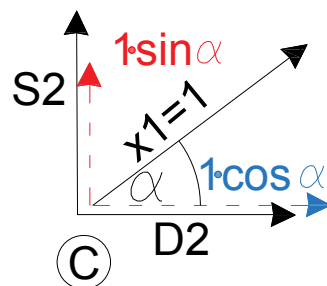
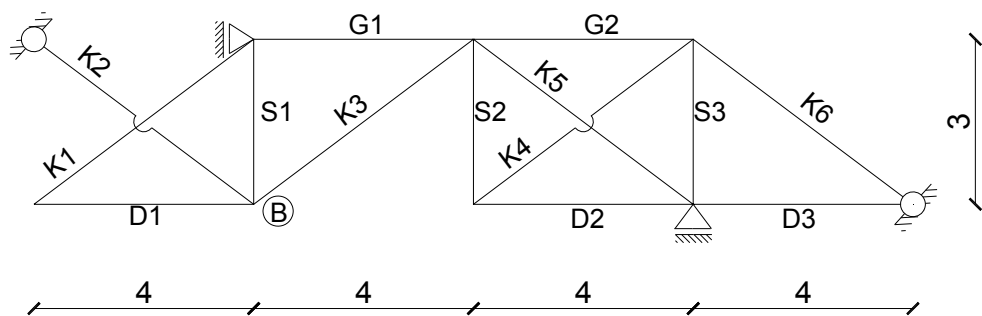
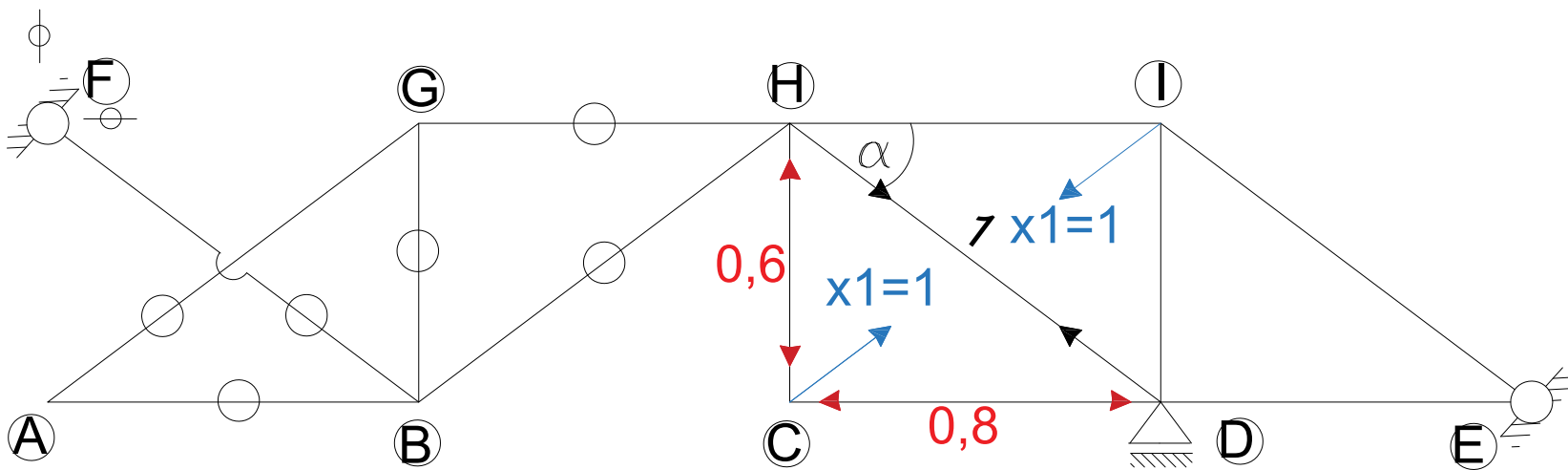

$$\sum R_y = S2 + x1 \cdot \sin \alpha = 0$$

$$\downarrow$$

$$S2 = -x1 \cdot \sin \alpha = -1 \cdot \frac{3}{5} = -0,6$$

$$\sum R_x = D2 + x1 \cdot \cos \alpha = 0$$

$$\downarrow$$

$$D2 = -x1 \cdot \cos \alpha = -1 \cdot \frac{4}{5} = -0,8$$



# Wykresy: stan $x_1=1$ , siły N1

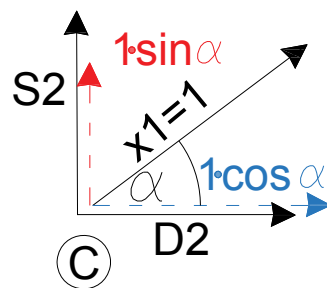
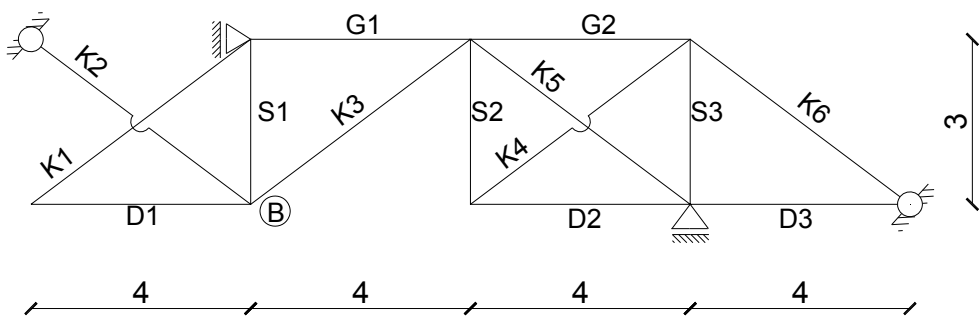
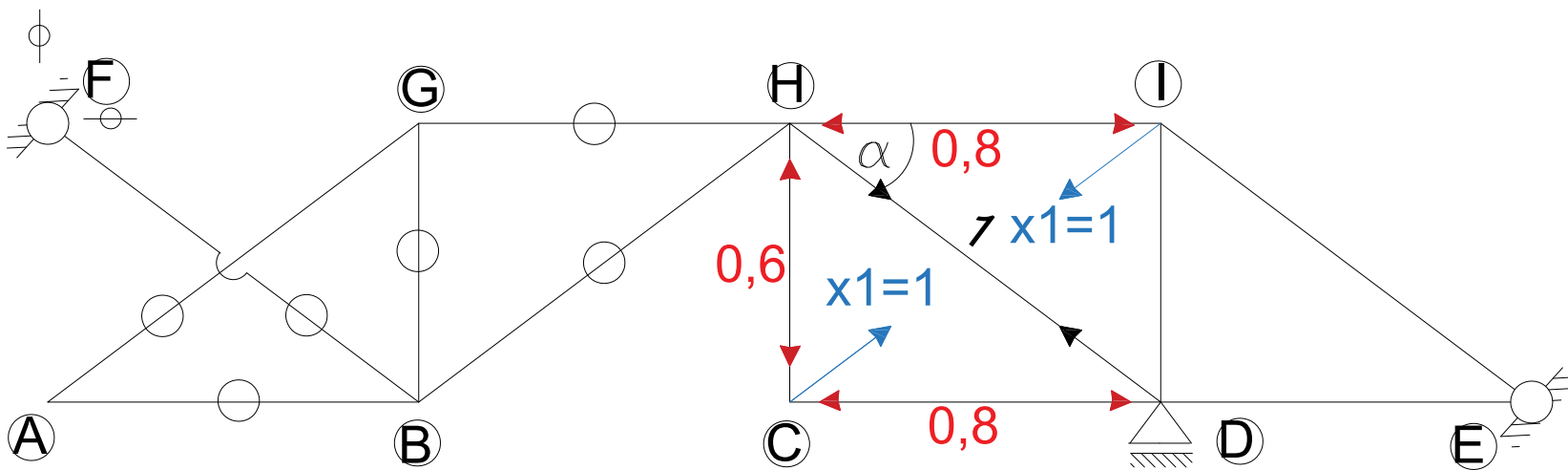

$$\sum R_y = S2 + x1 \cdot \sin \alpha = 0$$

$$\downarrow$$

$$S2 = -x1 \cdot \sin \alpha = -1 \cdot \frac{3}{5} = -0,6$$

$$\sum R_x = D2 + x1 \cdot \cos \alpha = 0$$

$$\downarrow$$

$$D2 = -x1 \cdot \cos \alpha = -1 \cdot \frac{4}{5} = -0,8$$

# Wykresy: stan $x_1=1$ , siły N1

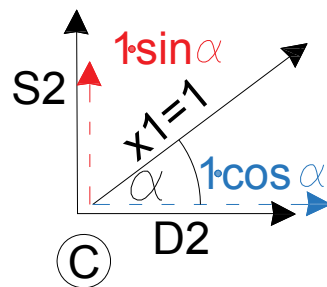
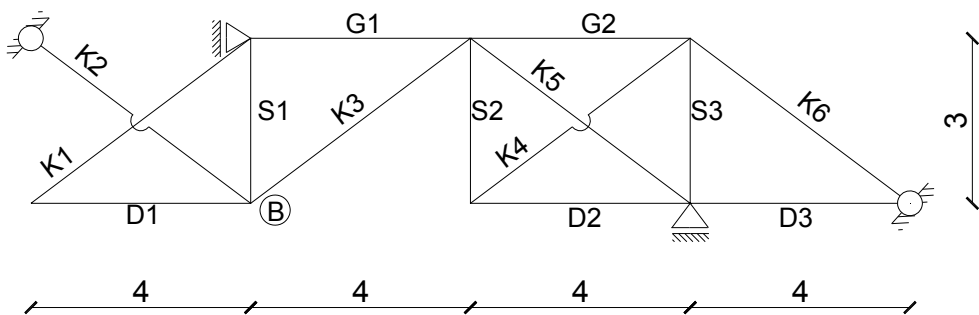
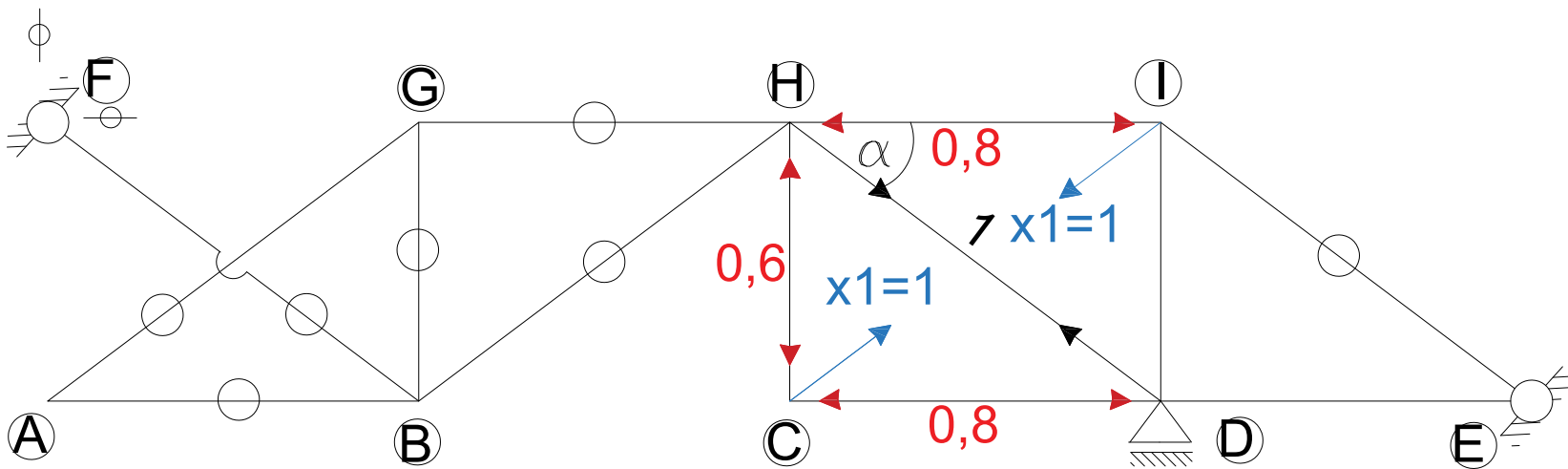

$$\sum R_y = S2 + x1 \cdot \sin \alpha = 0$$

$$\downarrow$$

$$S2 = -x1 \cdot \sin \alpha = -1 \cdot \frac{3}{5} = -0,6$$

$$\sum R_x = D2 + x1 \cdot \cos \alpha = 0$$

$$\downarrow$$

$$D2 = -x1 \cdot \cos \alpha = -1 \cdot \frac{4}{5} = -0,8$$

# Wykresy: stan $x_1=1$ , siły N1

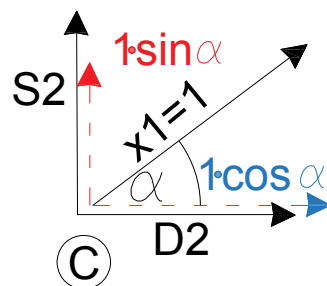
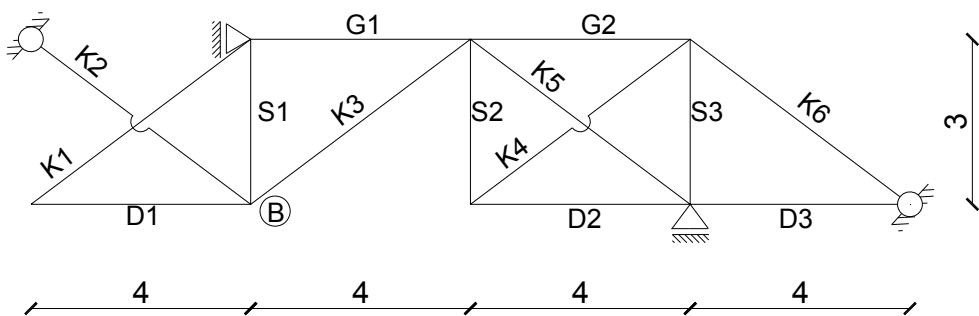
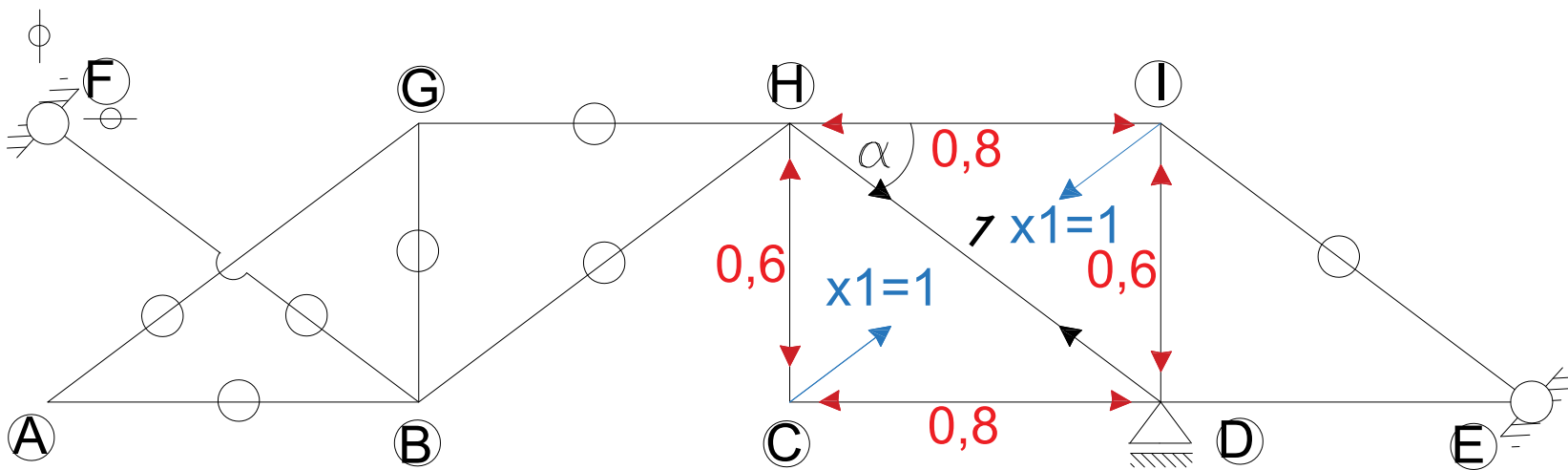

$$\sum R_y = S2 + x1 \cdot \sin \alpha = 0$$

$$\downarrow$$

$$S2 = -x1 \cdot \sin \alpha = -1 \cdot \frac{3}{5} = -0,6$$

$$\sum R_x = D2 + x1 \cdot \cos \alpha = 0$$

$$\downarrow$$

$$D2 = -x1 \cdot \cos \alpha = -1 \cdot \frac{4}{5} = -0,8$$

# Wykresy: stan $x_1=1$ , siły N1

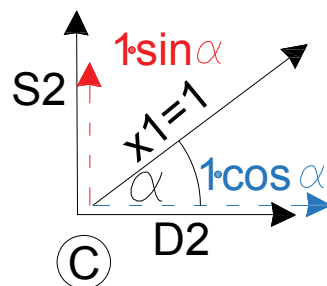
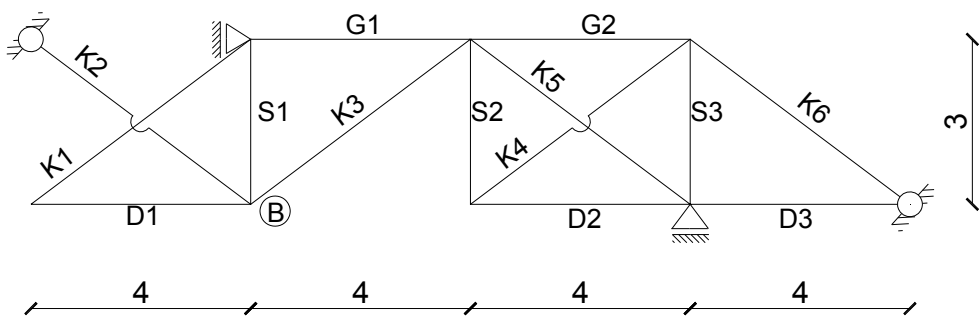
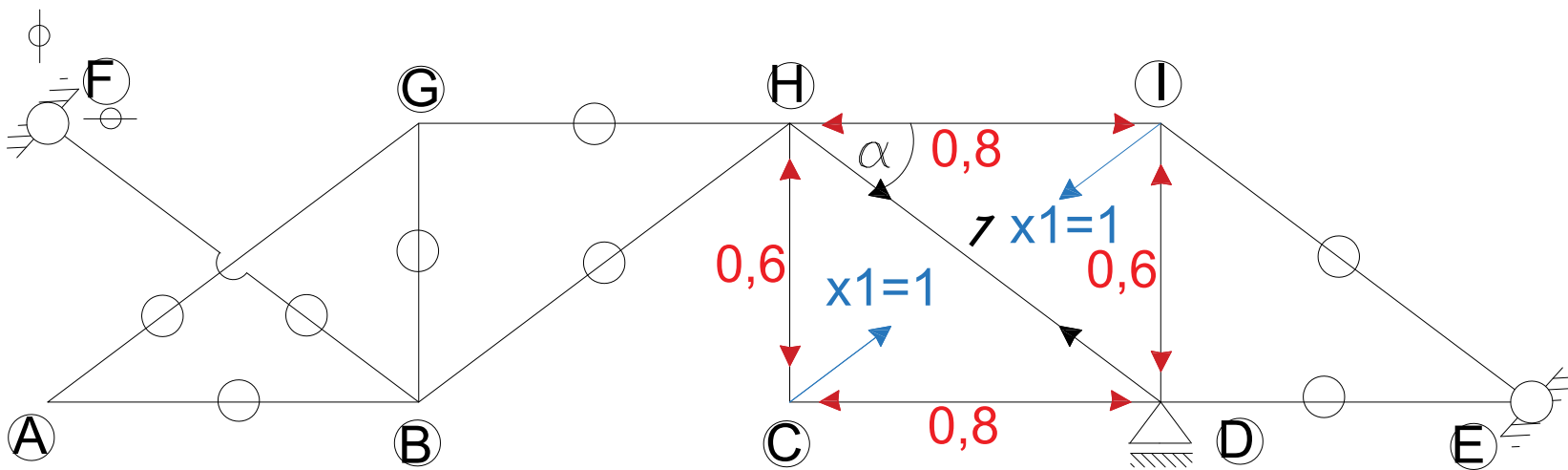

$$\sum R_y = S2 + x1 \cdot \sin \alpha = 0$$

$$\downarrow$$

$$S2 = -x1 \cdot \sin \alpha = -1 \cdot \frac{3}{5} = -0,6$$

$$\sum R_x = D2 + x1 \cdot \cos \alpha = 0$$

$$\downarrow$$

$$D2 = -x1 \cdot \cos \alpha = -1 \cdot \frac{4}{5} = -0,8$$

# Wykresy: stan $x_1=1$ , siły N1

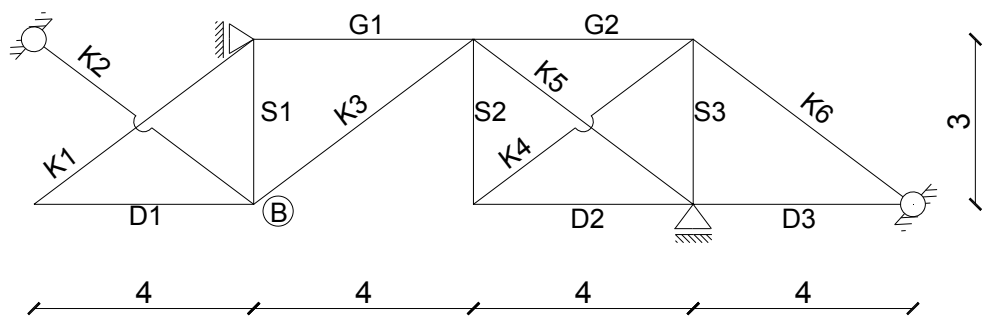
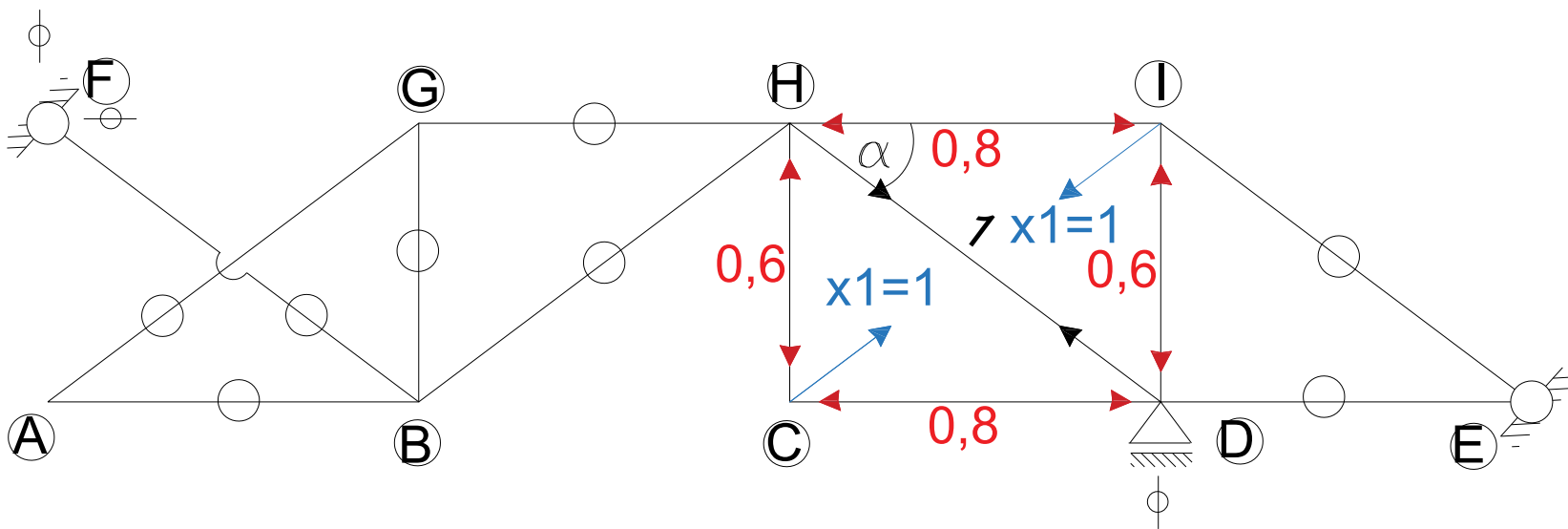

## Wykresy: stan $x_1=1$ , siły N1

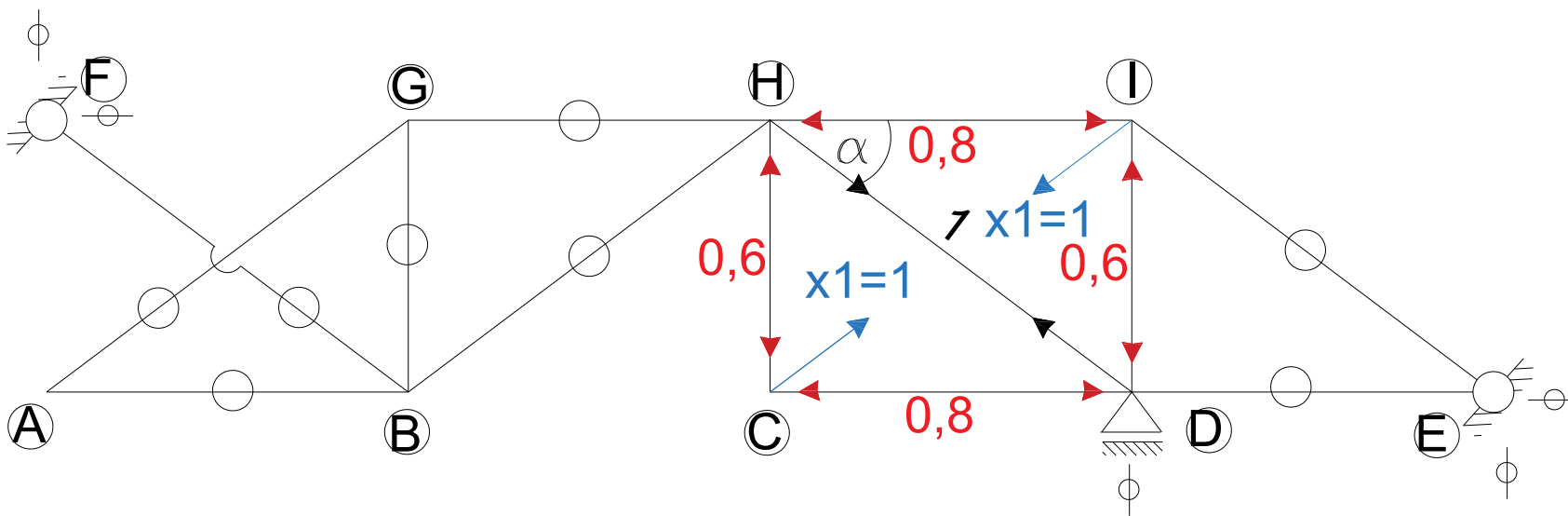

Pręt	L/EA	N1
D1	4	0
D2	4	-0,8
D3	4	0
G1	4	0
G2	4	-0,8
S1	3	0
S2	3	-0,6
S3	3	-0,6
K1	2,5	0
K2	2,5	0
K3	2,5	0
K4	2,5	1
K5	2,5	1
K6	2,5	0

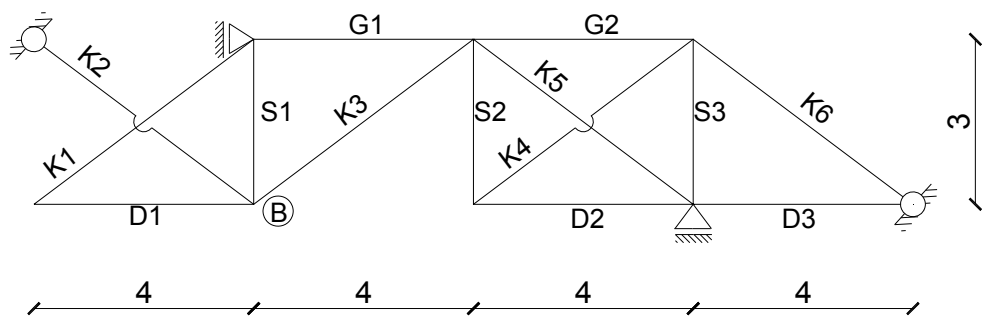

## Wykresy: stan $x_2=1$ – siły N2

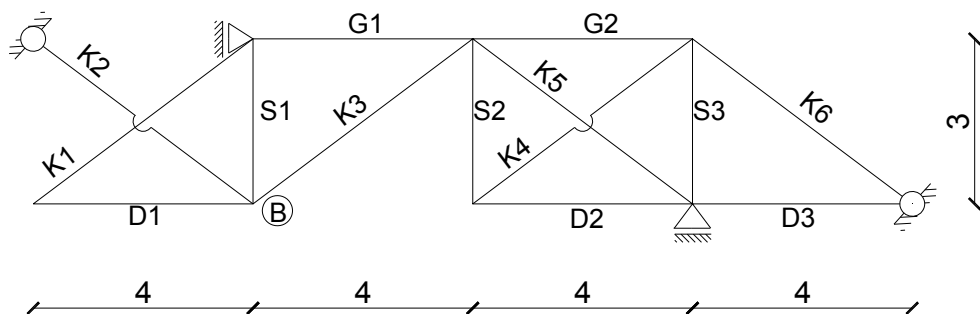
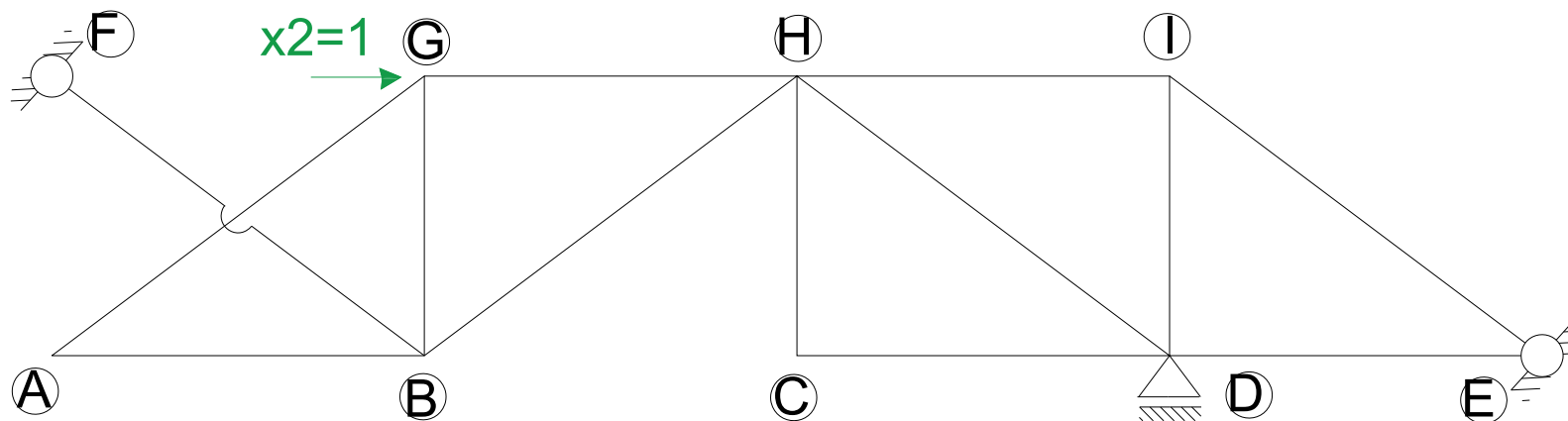

## Wykresy: stan $x_2=1$ – siły N2

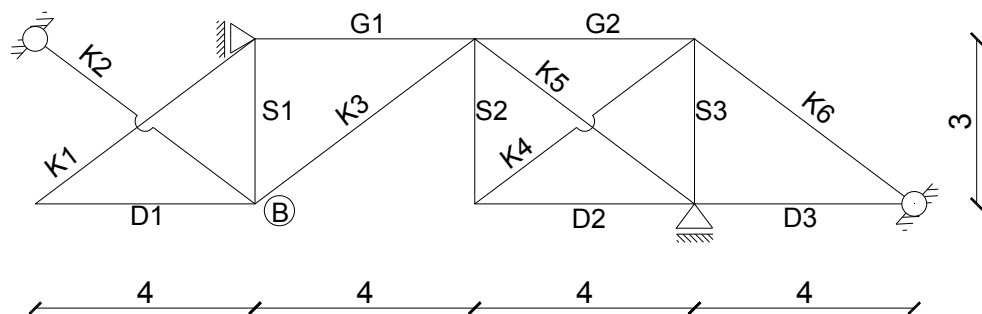
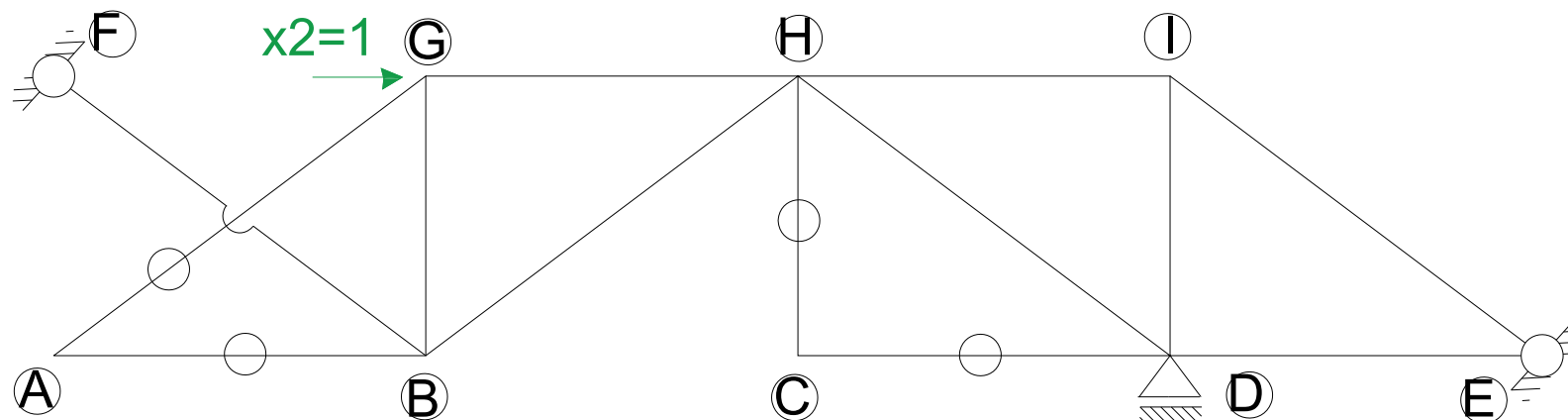



# Wykresy: stan $x_2=1$ – siły N2

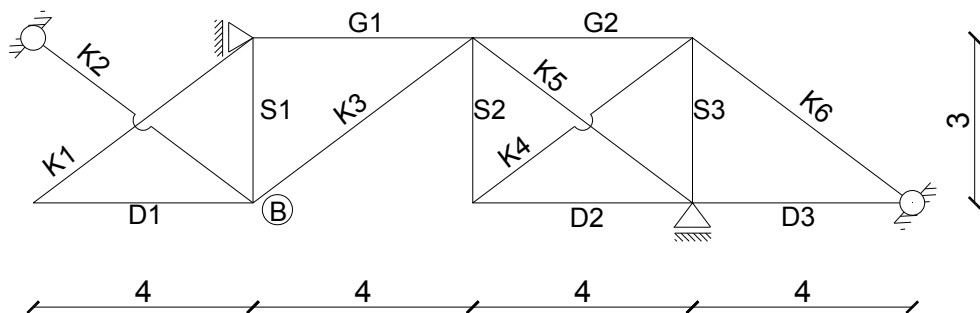
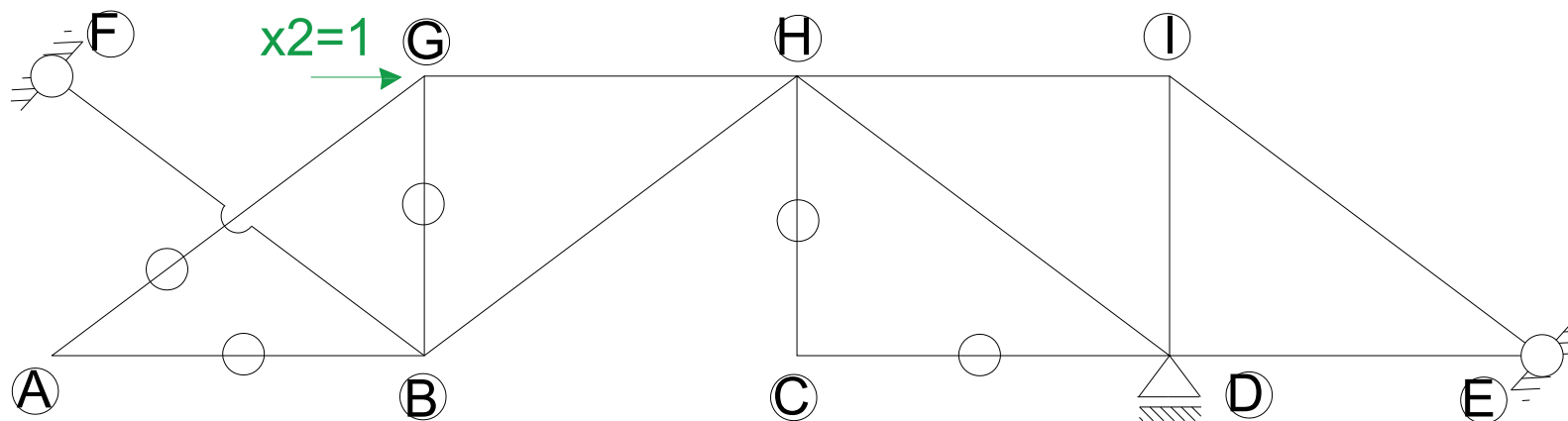

# Wykresy: stan $x_2=1$ – siły N2

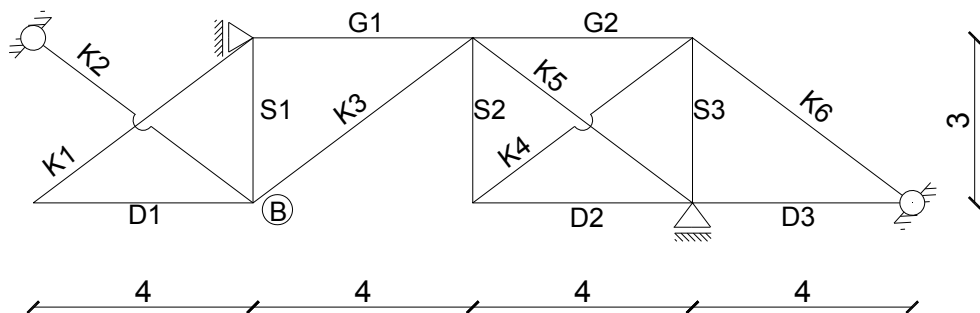
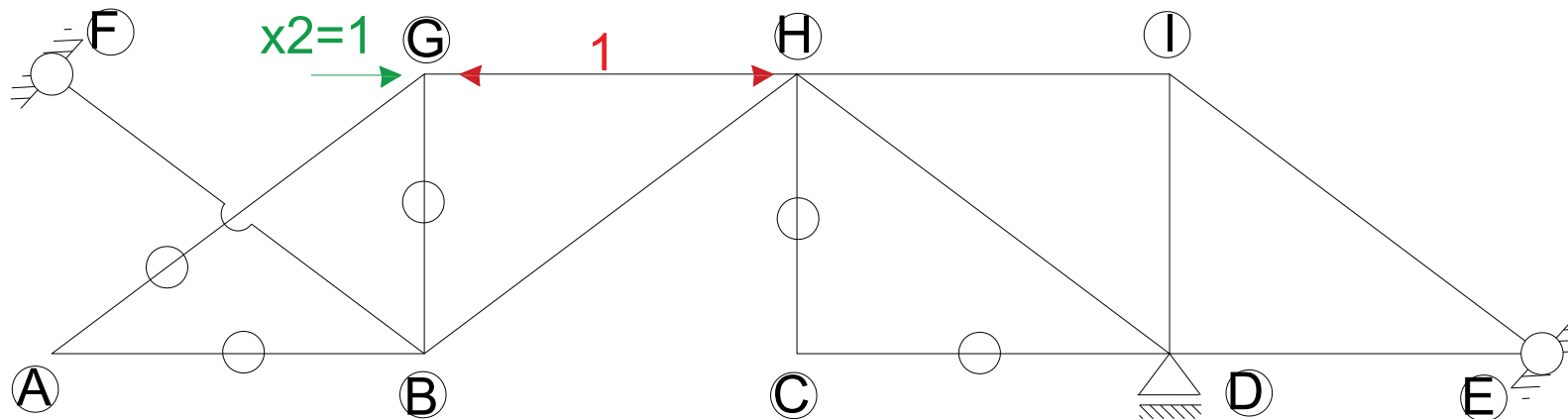

# Wykresy: stan $x_2=1$ – siły N2

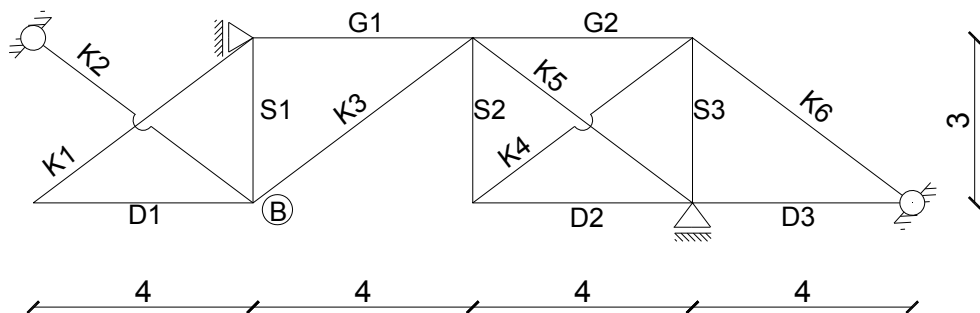
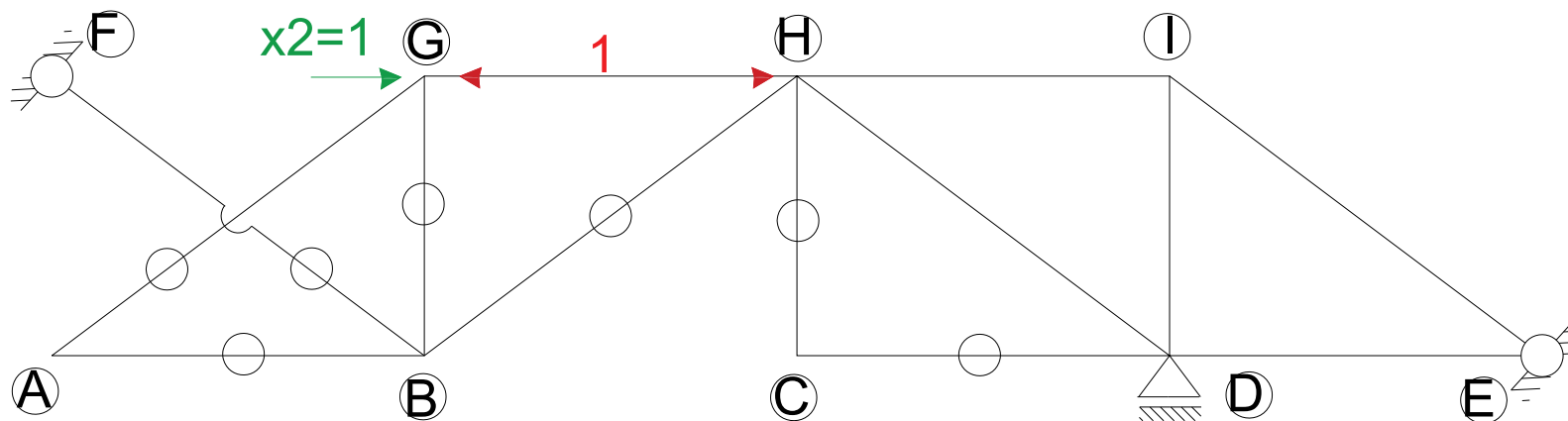

# Wykresy: stan $x_2=1$ – siły N2

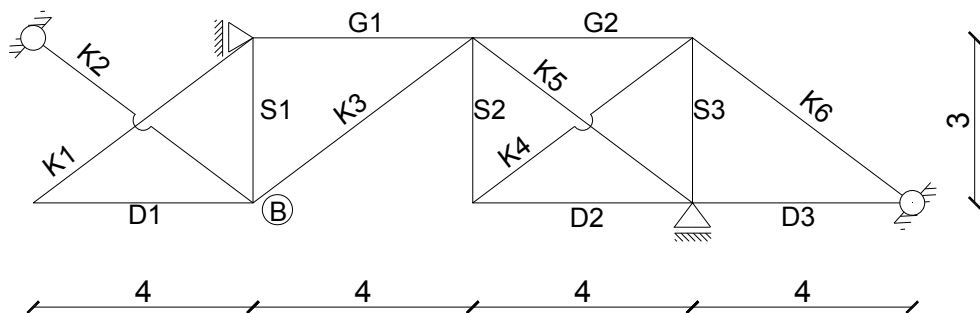
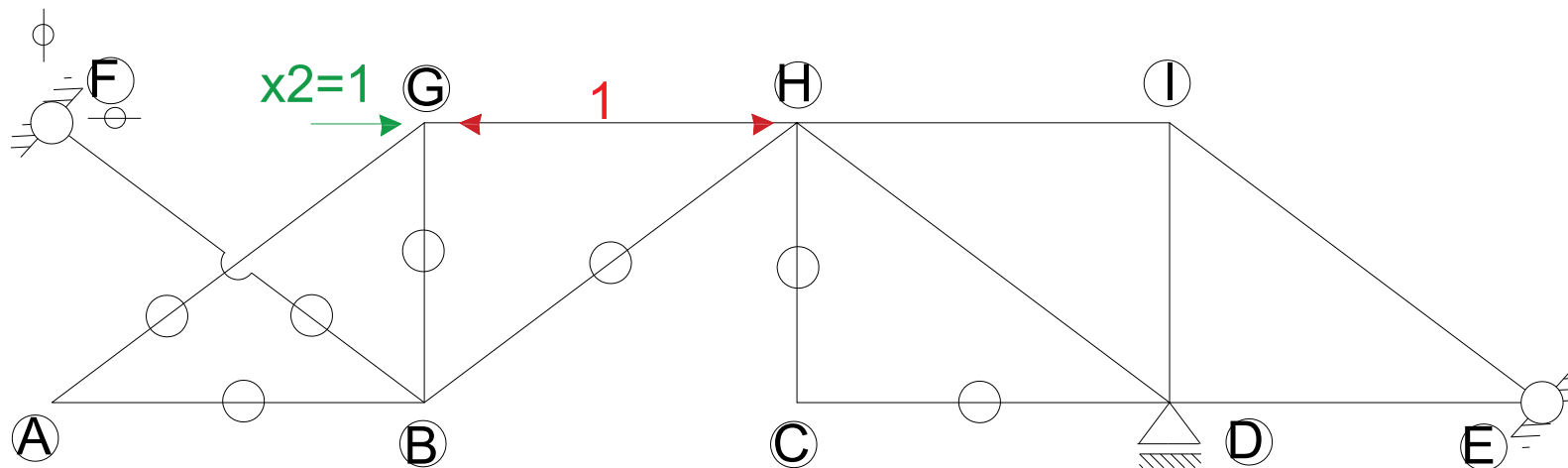

# Wykresy: stan $x_2=1$ – siły N2

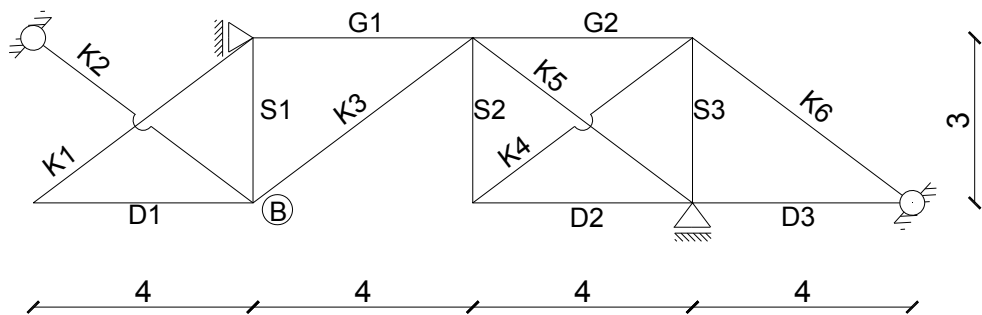
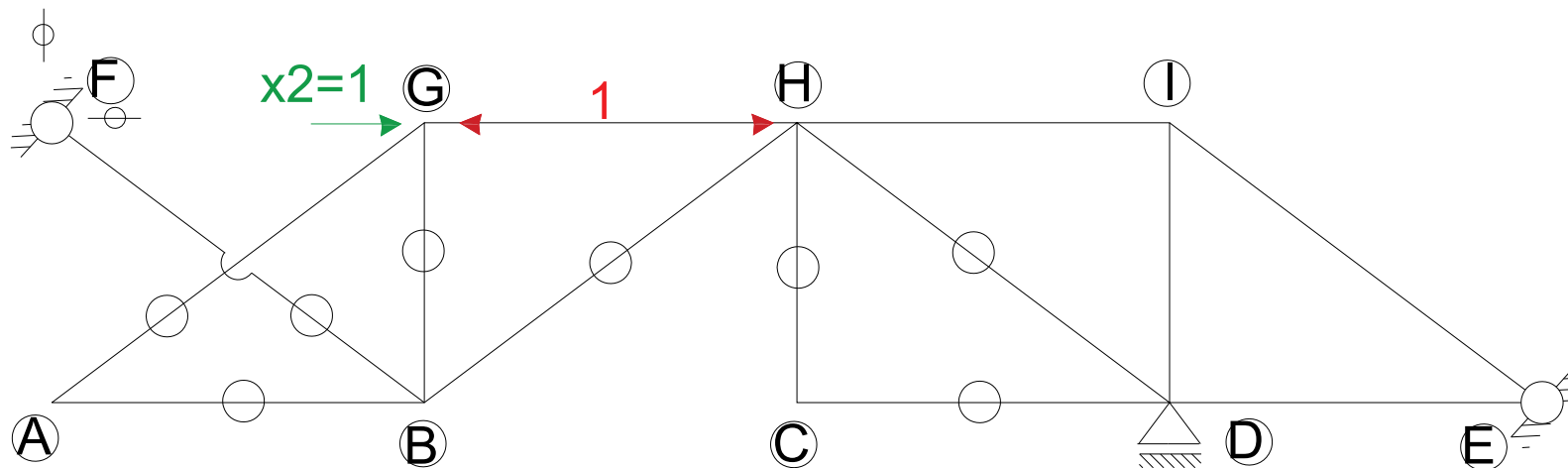

## Wykresy: stan $x_2=1$ – siły N2

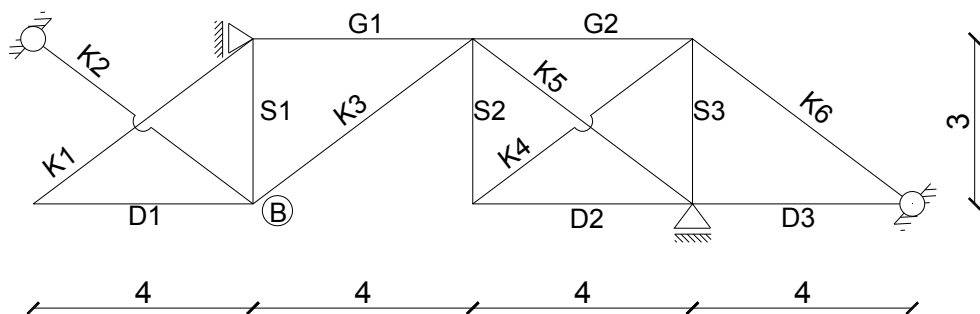
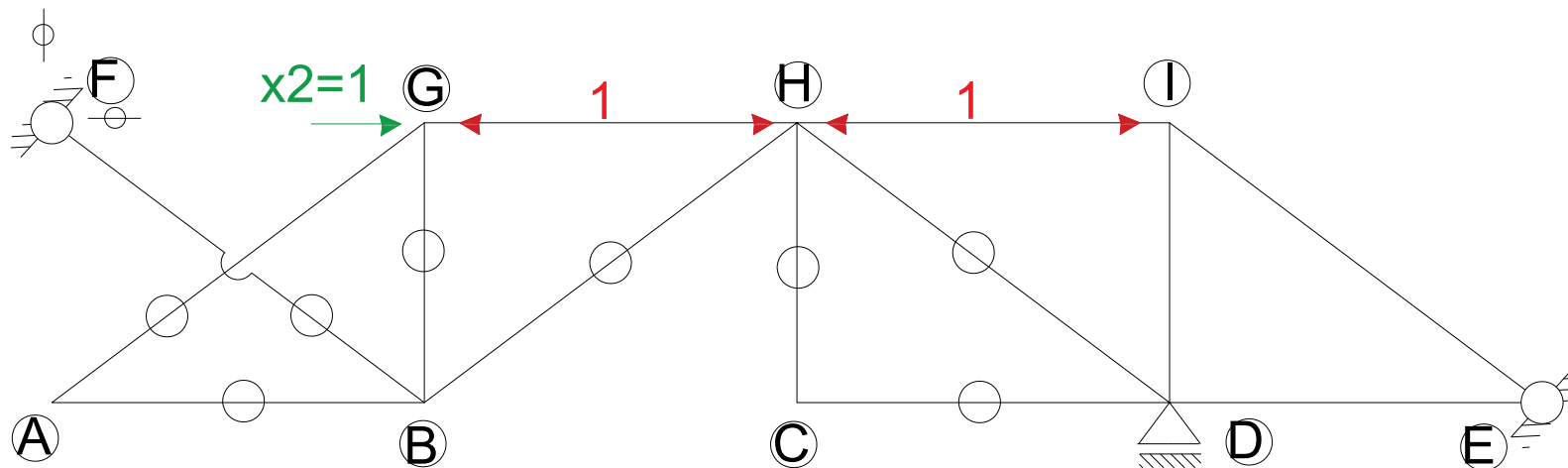

# Wykresy: stan $x_2=1$ – siły N2

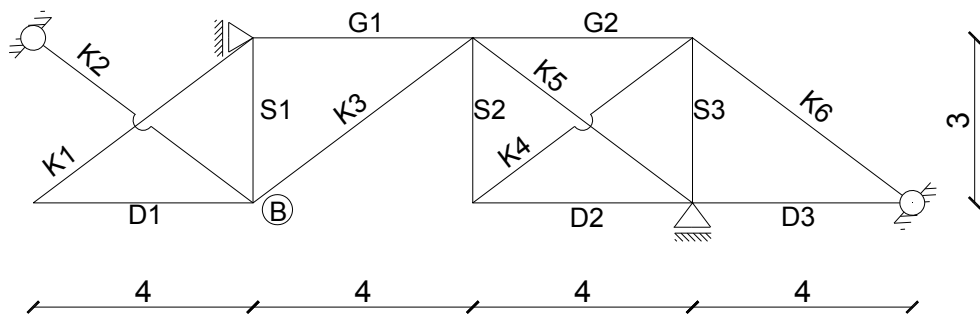
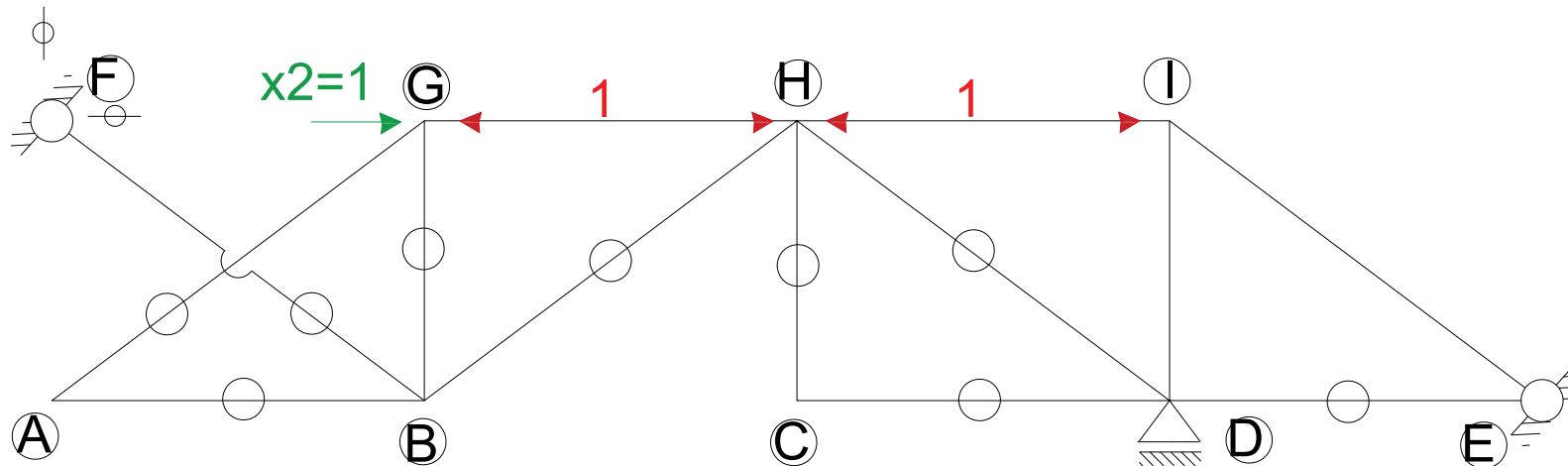

## Wykresy: stan $x_2=1$ – siły N2

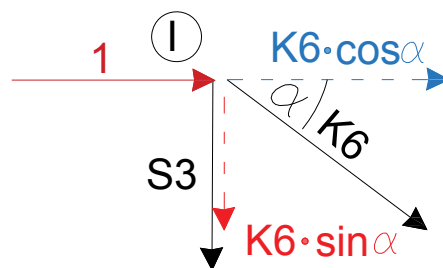
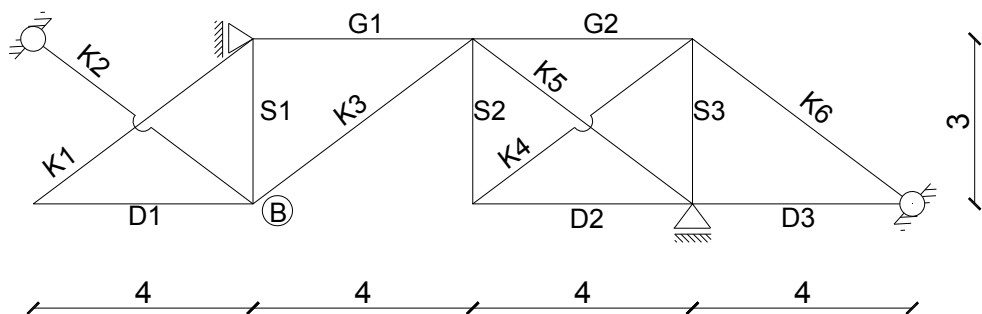
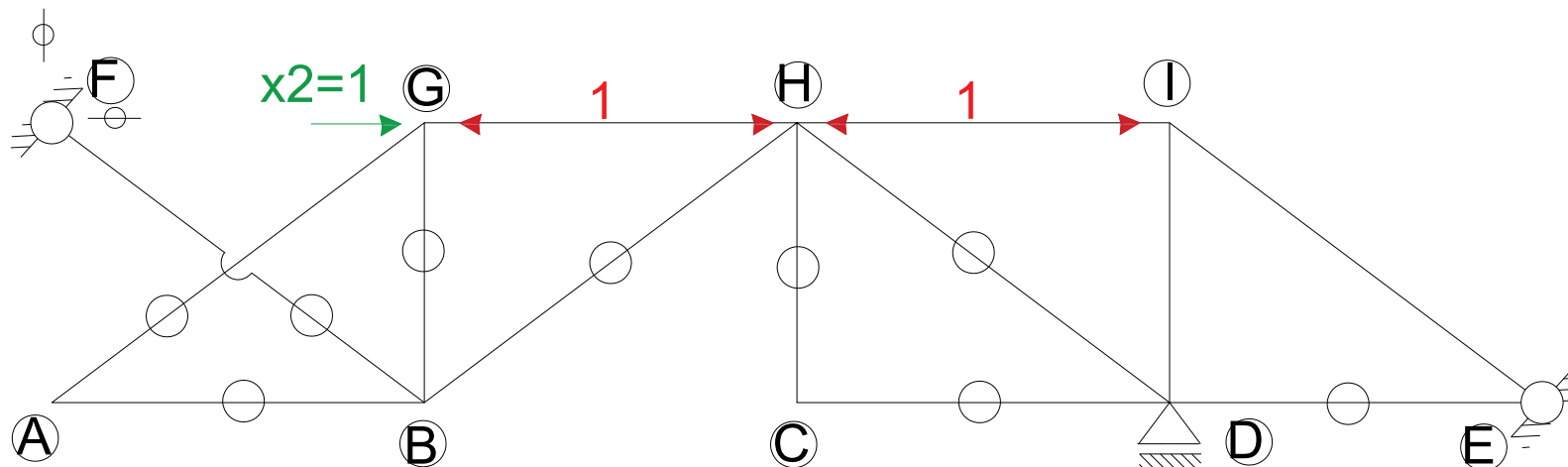

$$\sum R_x = 1 + K_6 \cdot \cos \alpha = 0$$

$$K_6 = -\frac{1}{\cos \alpha} = -\frac{5}{4} = -1,25$$

$$\sum R_y = -S_3 - K_6 \cdot \sin \alpha = 0$$

$$S_3 = -K_6 \cdot \sin \alpha = -\left(-\frac{5}{4}\right) \cdot \frac{3}{5} = \frac{3}{4} = 0,75$$



## Wykresy: stan $x_2=1$ – siły N2

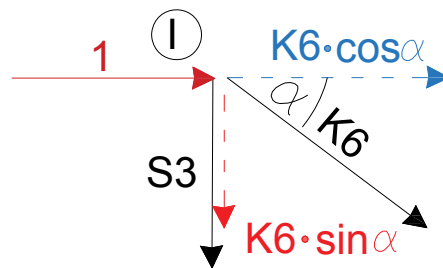
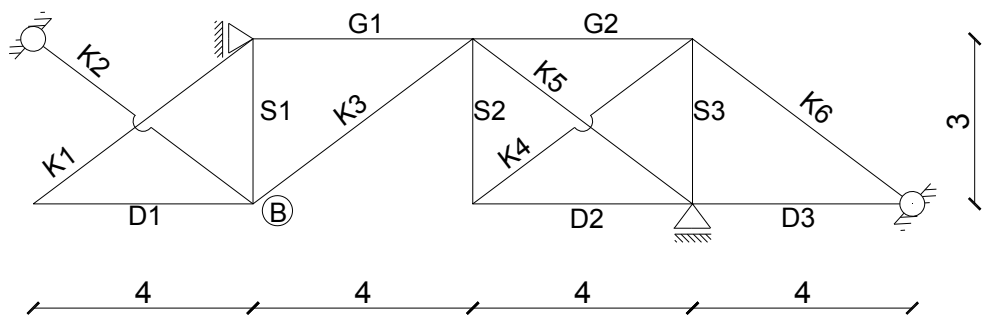
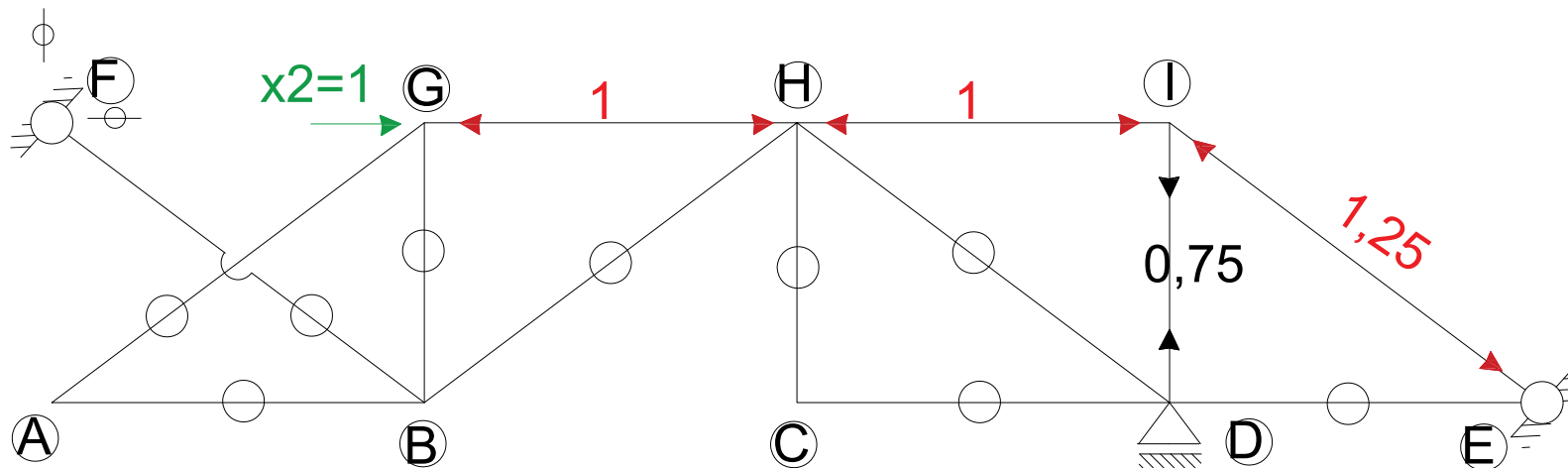

$$\sum R_x = 1 + K_6 \cdot \cos \alpha = 0$$

$$K_6 = -\frac{1}{\cos \alpha} = -\frac{5}{4} = -1,25$$

$$\sum R_y = -S_3 - K_6 \cdot \sin \alpha = 0$$

$$S_3 = -K_6 \cdot \sin \alpha = -\left(-\frac{5}{4}\right) \cdot \frac{3}{5} = \frac{3}{4} = 0,75$$

# Wykresy: stan $x_2=1$ – siły N2

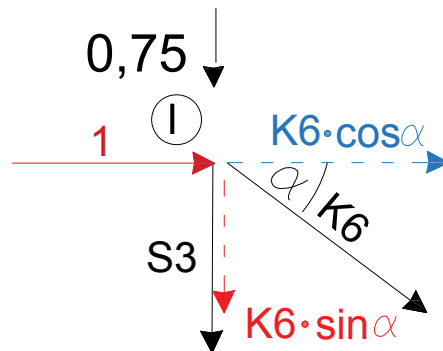
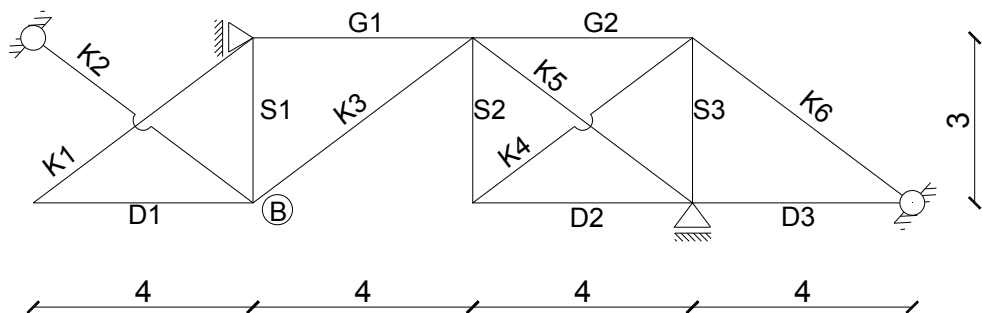
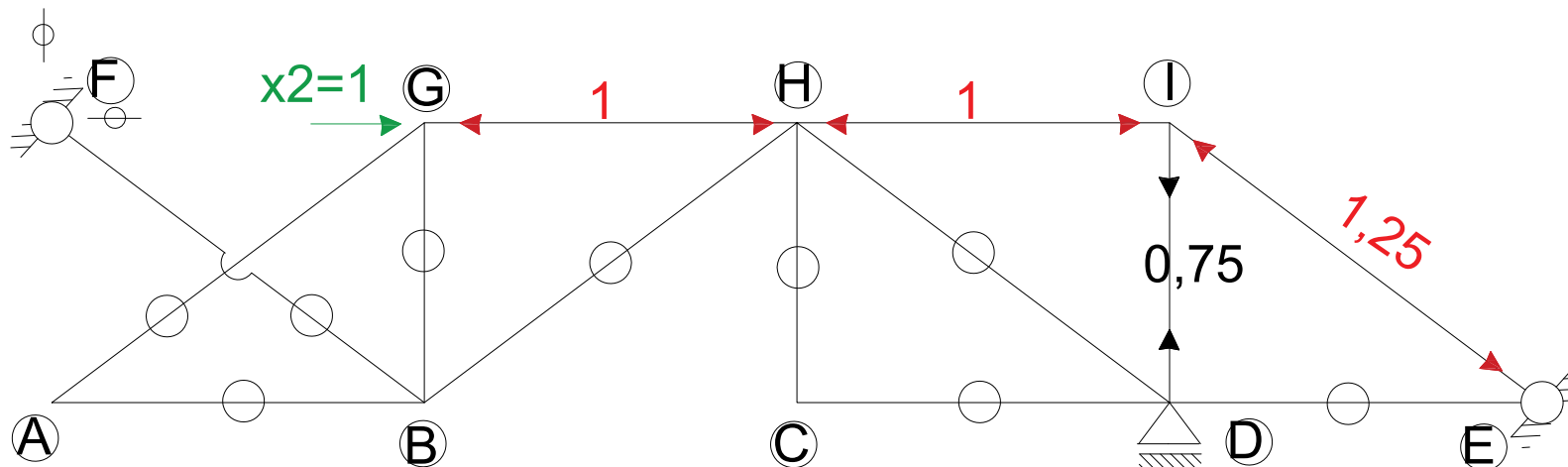

$$\sum R_x = 1 + K6 \cdot \cos \alpha = 0$$

$$K6 = -\frac{1}{\cos \alpha} = -\frac{5}{4} = -1,25$$

$$\sum R_y = -S3 - K6 \cdot \sin \alpha = 0$$

$$S3 = -K6 \cdot \sin \alpha = -\left(-\frac{5}{4}\right) \cdot \frac{3}{5} = \frac{3}{4} = 0,75$$

# Wykresy: stan $x_2=1$ – siły N2

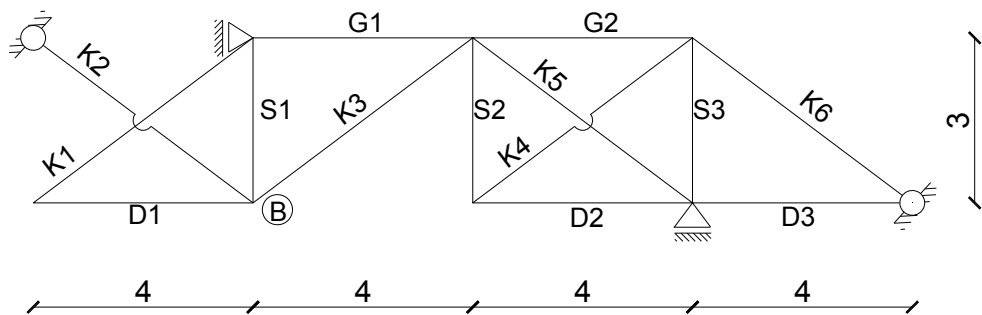
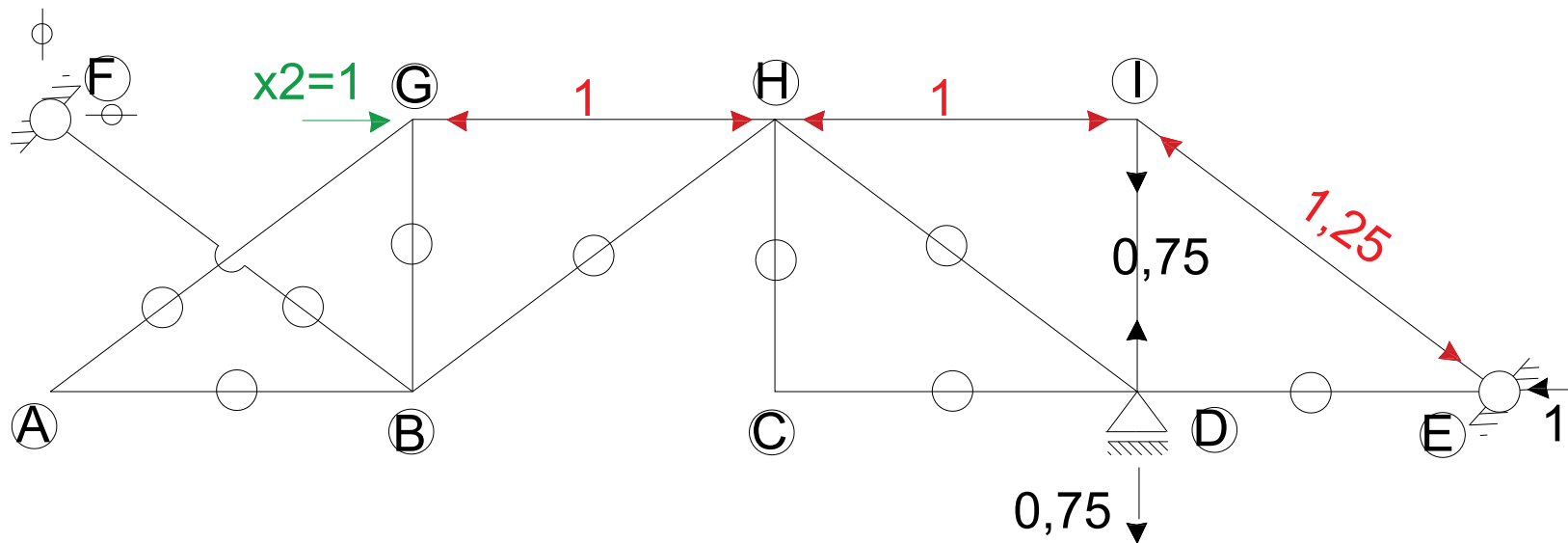

# Wykresy: stan $x_2=1$ – siły N2

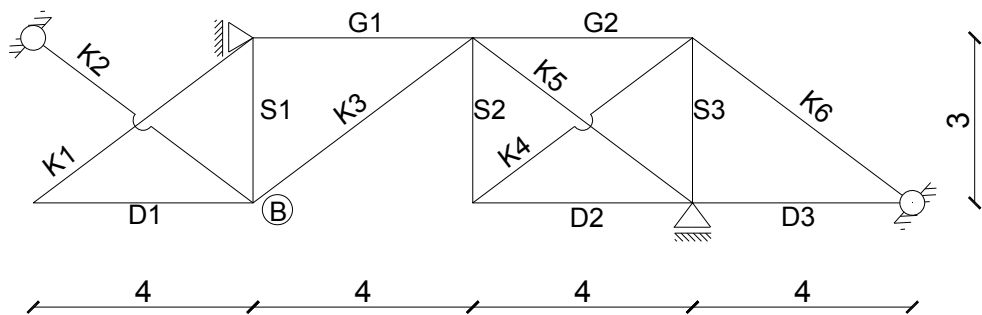
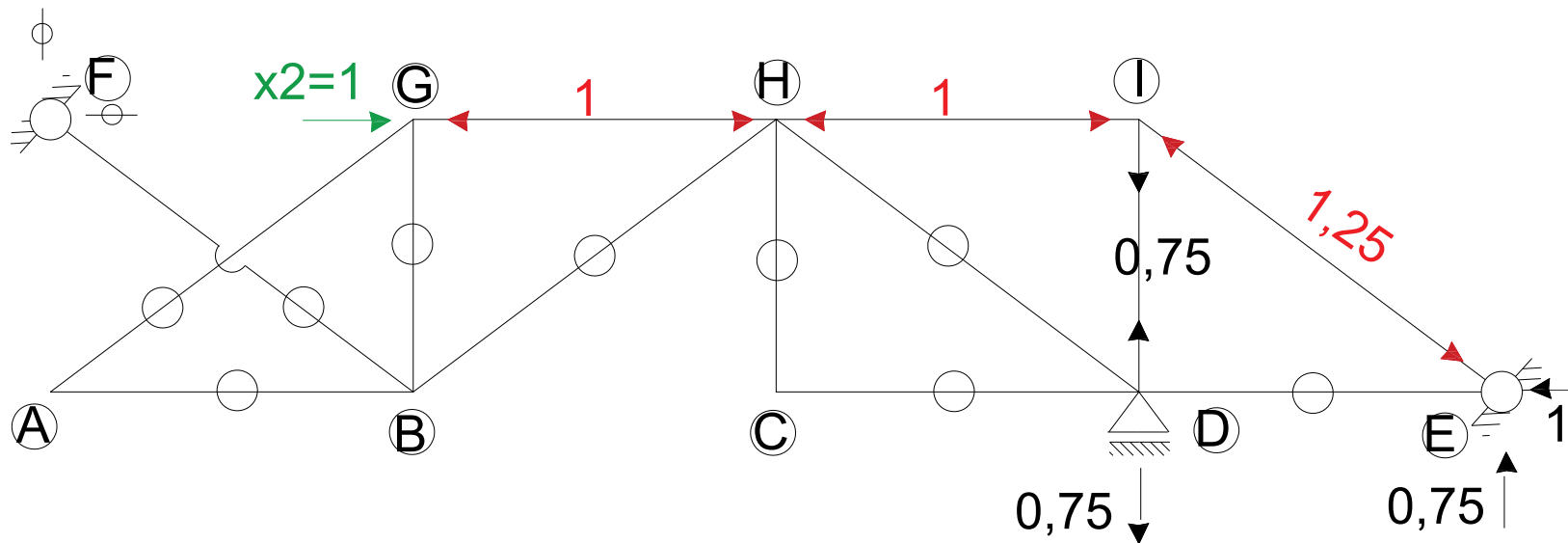

## Wykresy: stan $x_2=1$ – siły N2

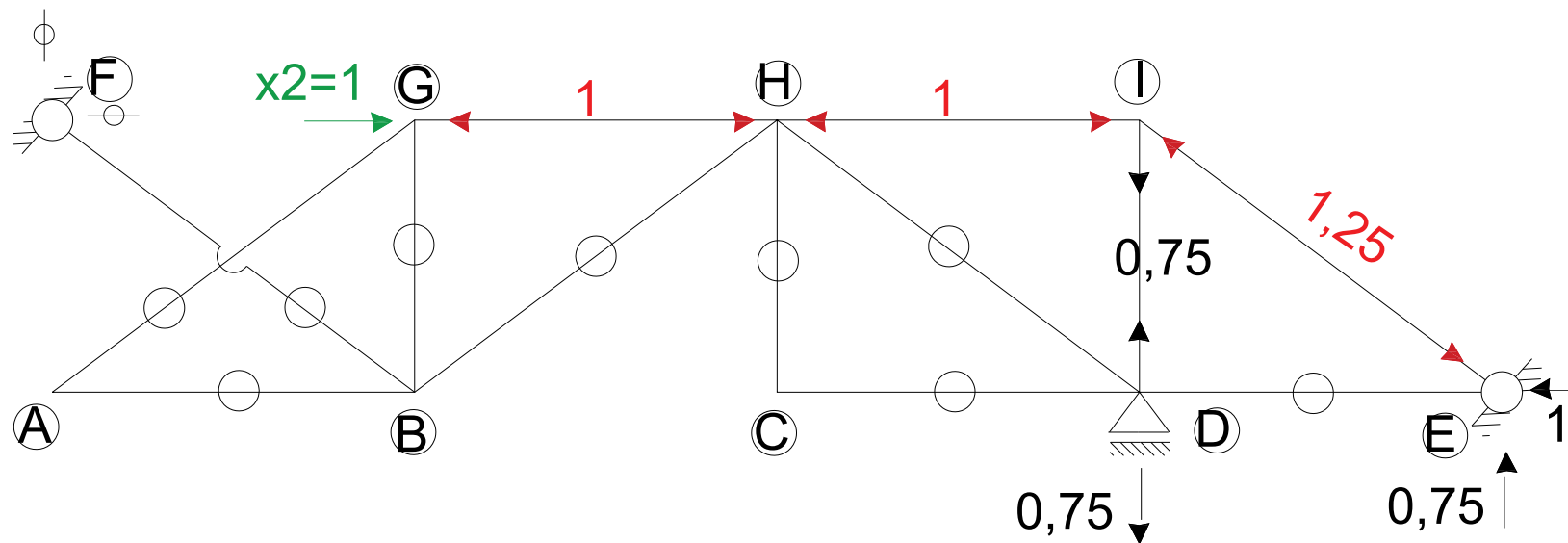

Pręt	L/EA	N2
D1	4	0
D2	4	0
D3	4	0
G1	4	-1
G2	4	-1
S1	3	0
S2	3	0
S3	3	0,75
K1	2,5	0
K2	2,5	0
K3	2,5	0
K4	2,5	0
K5	2,5	0
K6	2,5	-1,25

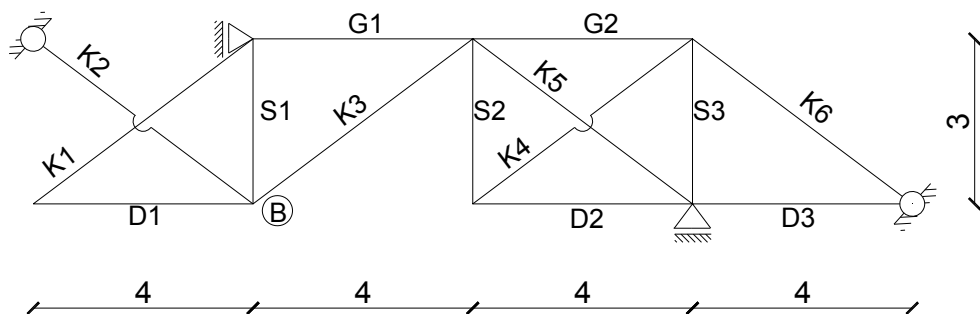

## Wykresy: obciążenie zewnętrzne – siły N0 [kN]

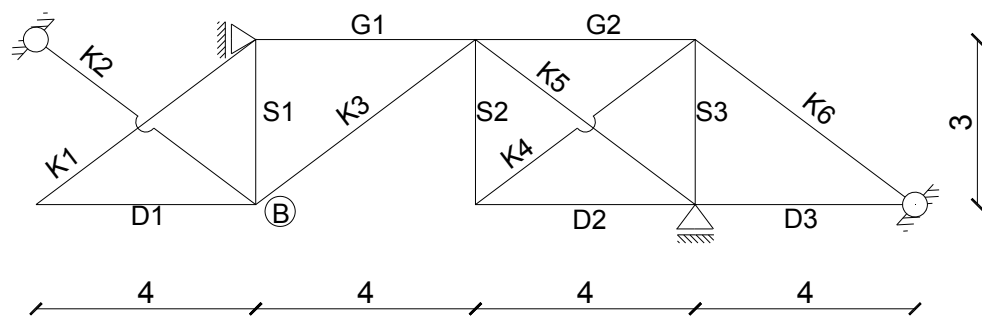
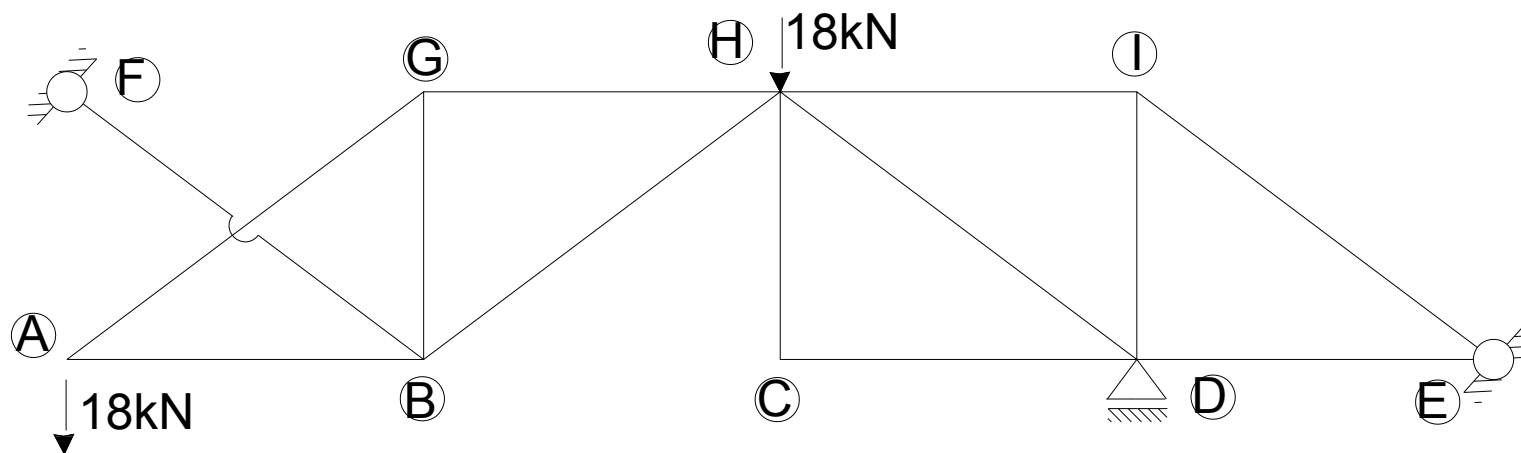

## Wykresy: obciążenie zewnętrzne – siły N0 [kN]

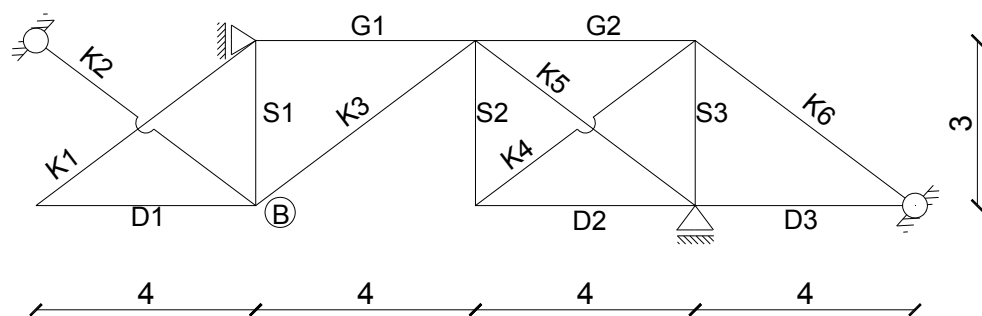
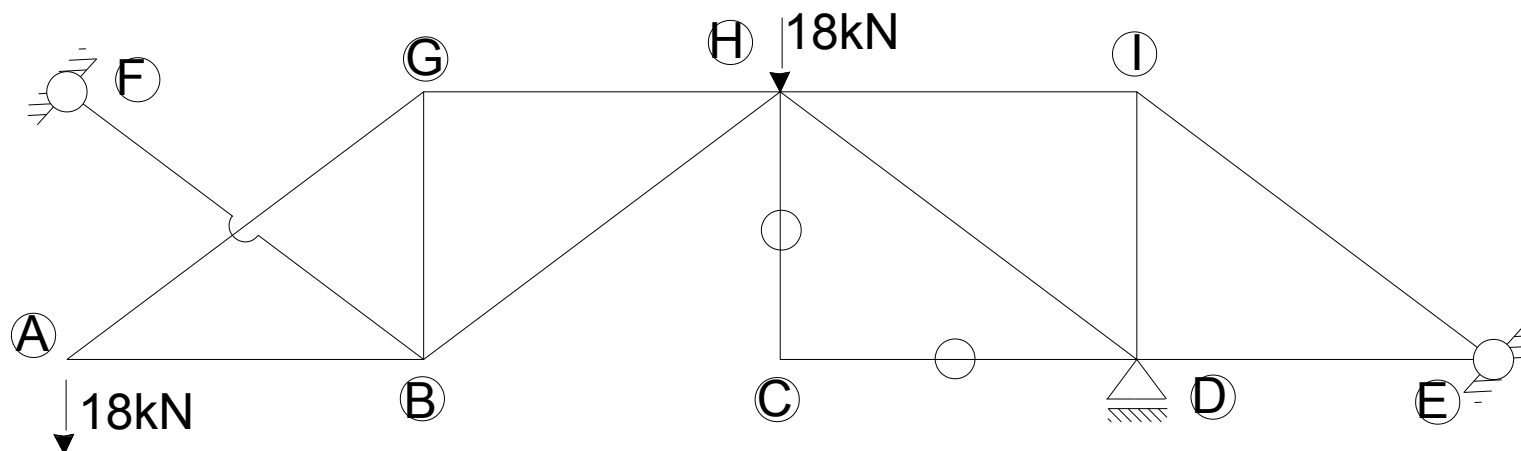

## Wykresy: obciążenie zewnętrzne – siły N0 [kN]

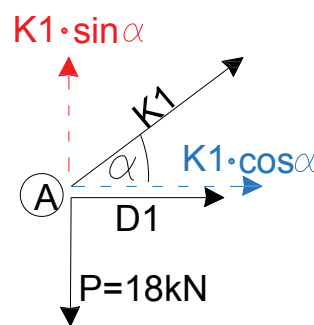
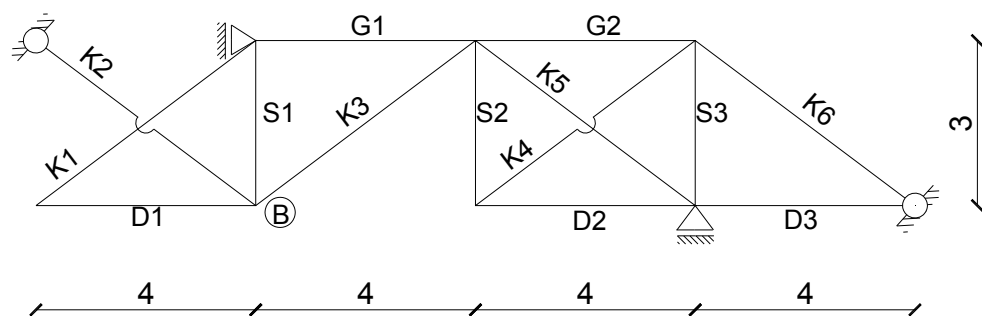
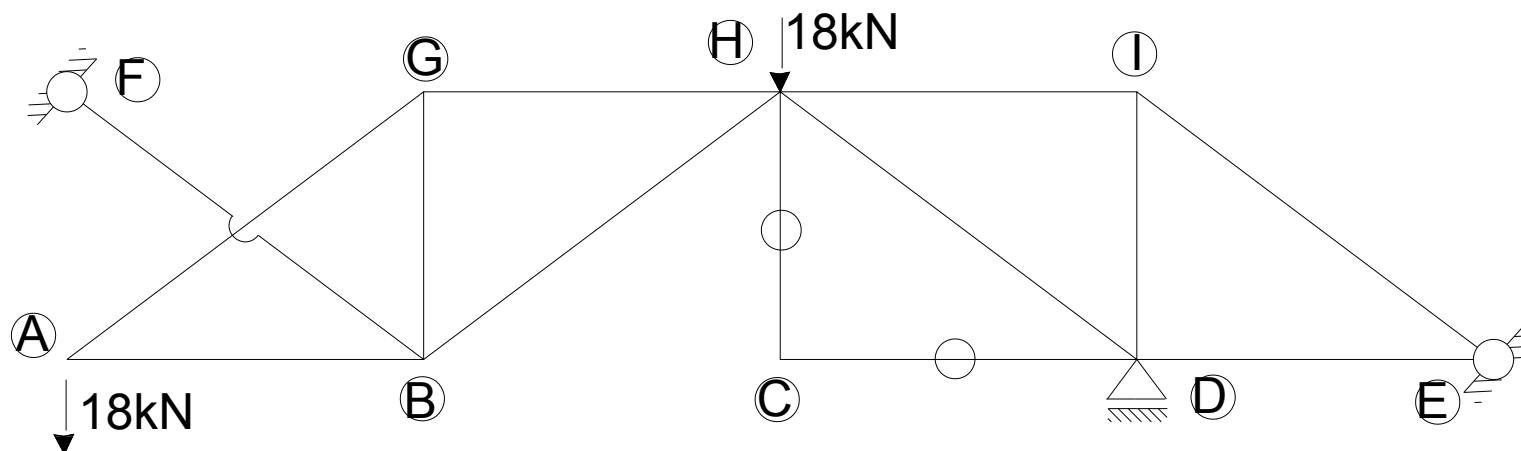

$$\sum R_Y = -18 + K1 \cdot \sin \alpha = 0$$



$$K1 = \frac{18}{\sin \alpha} = 18 \cdot \frac{5}{3} = 30 \text{ kN}$$

$$\sum R_X = D1 + K1 \cdot \cos \alpha = 0$$

$$D1 = -K1 \cdot \cos \alpha = -30 \cdot \frac{4}{5} = -24 \text{ kN}$$



## Wykresy: obciążenie zewnętrzne – siły N0 [kN]

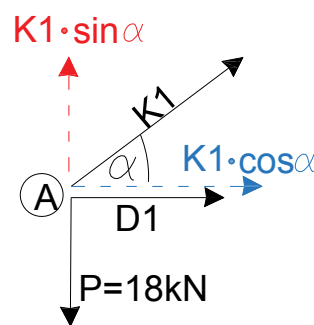
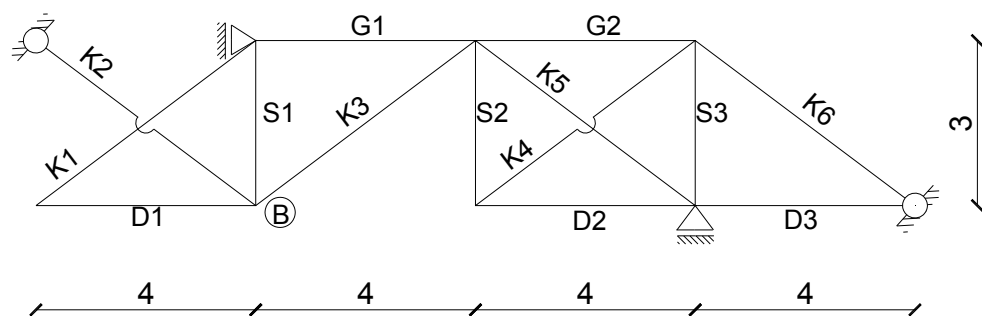
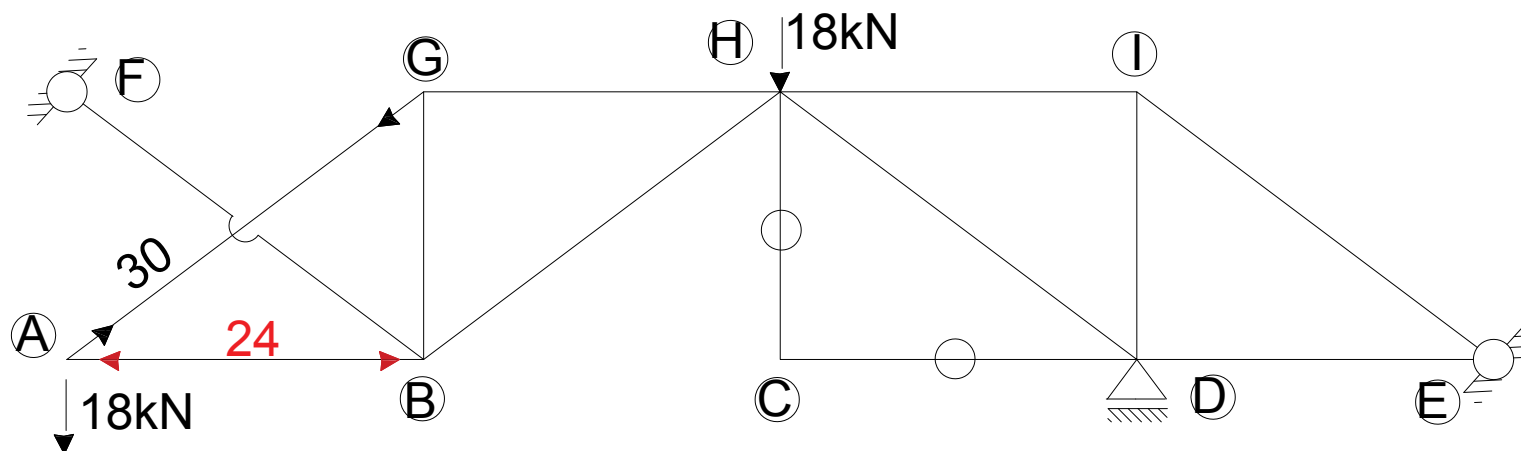

$$\sum R_Y = -18 + K1 \cdot \sin \alpha = 0$$



$$K1 = \frac{18}{\sin \alpha} = 18 \cdot \frac{5}{3} = 30 \text{ kN}$$

$$\sum R_X = D1 + K1 \cdot \cos \alpha = 0$$

$$D1 = -K1 \cdot \cos \alpha = -30 \cdot \frac{4}{5} = -24 \text{ kN}$$

## Wykresy: obciążenie zewnętrzne – siły N0 [kN]

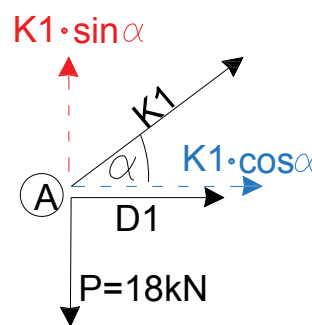
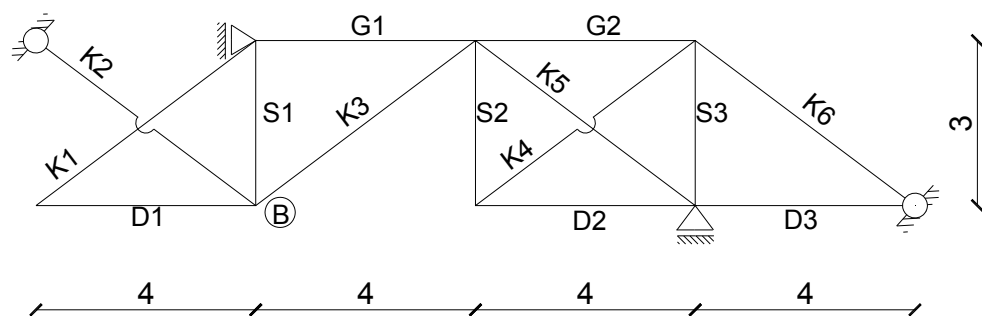
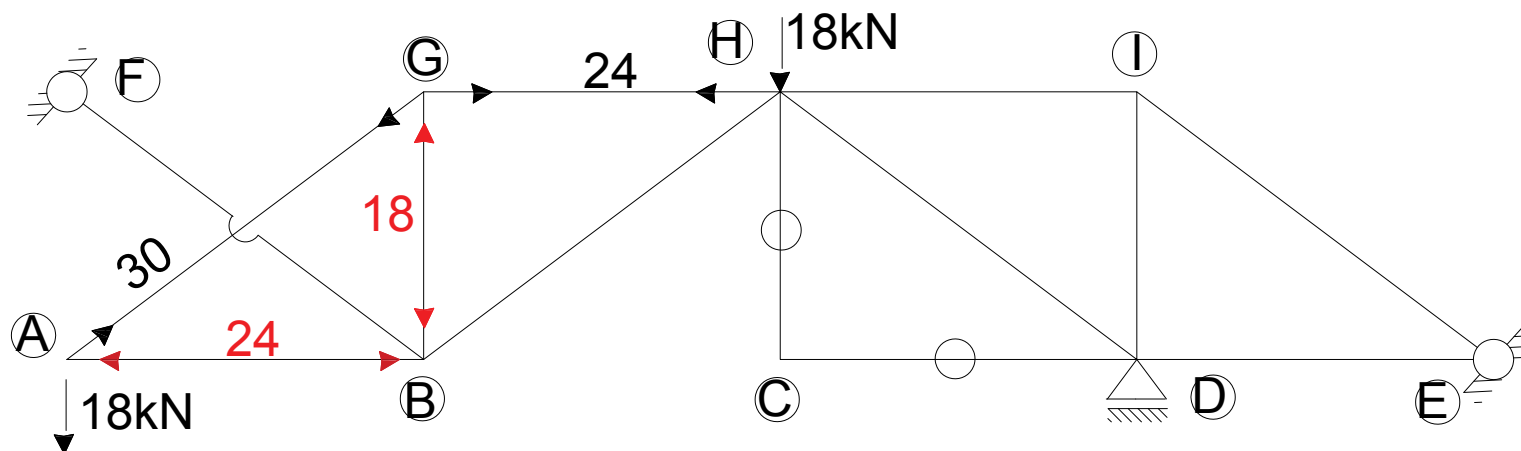

$$\sum R_Y = -18 + K1 \cdot \sin \alpha = 0$$



$$K1 = \frac{18}{\sin \alpha} = 18 \cdot \frac{5}{3} = 30 \text{ kN}$$

$$\sum R_X = D1 + K1 \cdot \cos \alpha = 0$$

$$D1 = -K1 \cdot \cos \alpha = -30 \cdot \frac{4}{5} = -24 \text{ kN}$$

## Wykresy: obciążenie zewnętrzne – siły N0 [kN]

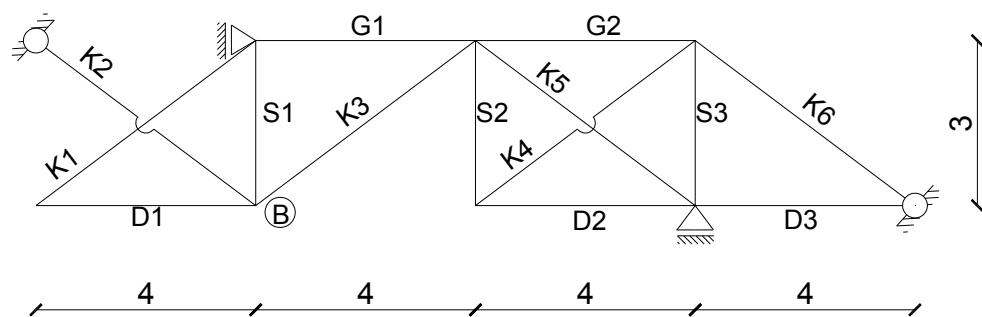
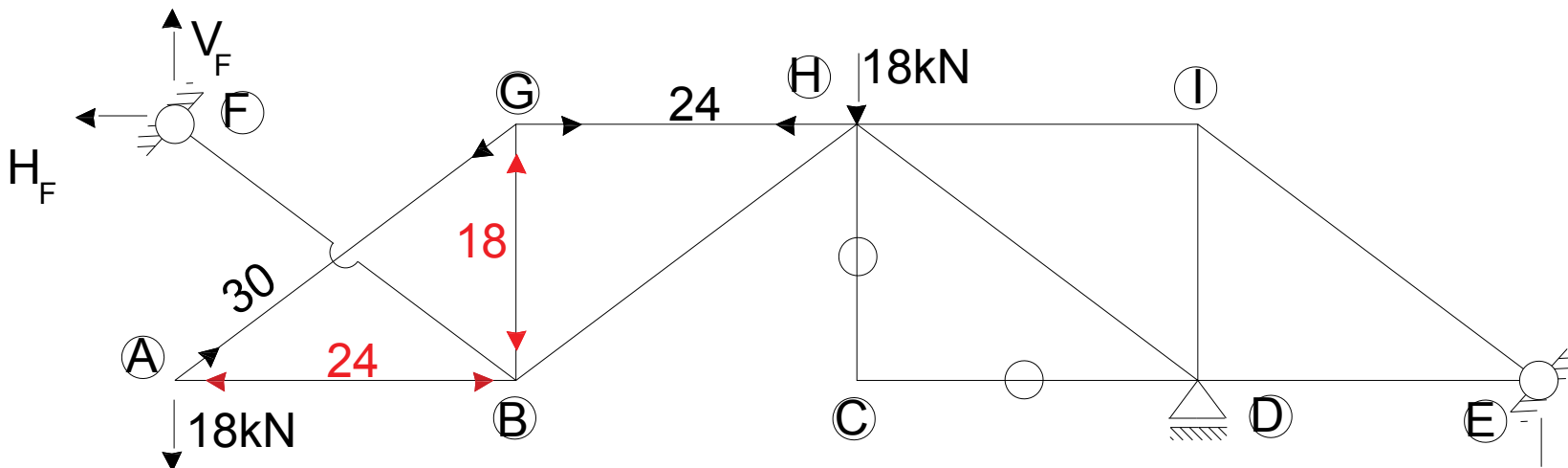



## Wykresy: obciążenie zewnętrzne – siły N0 [kN]

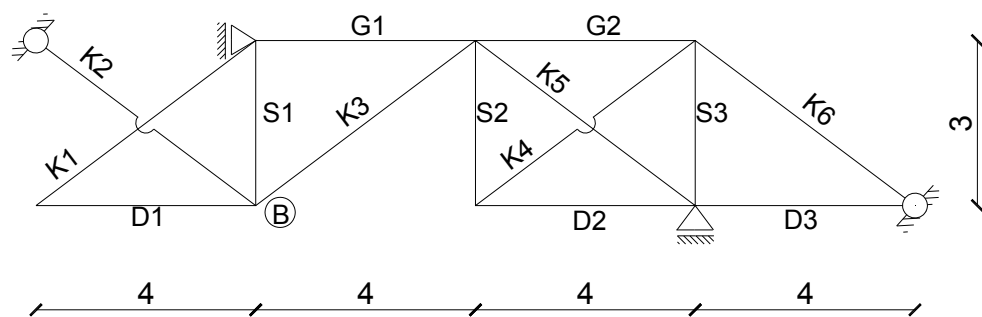
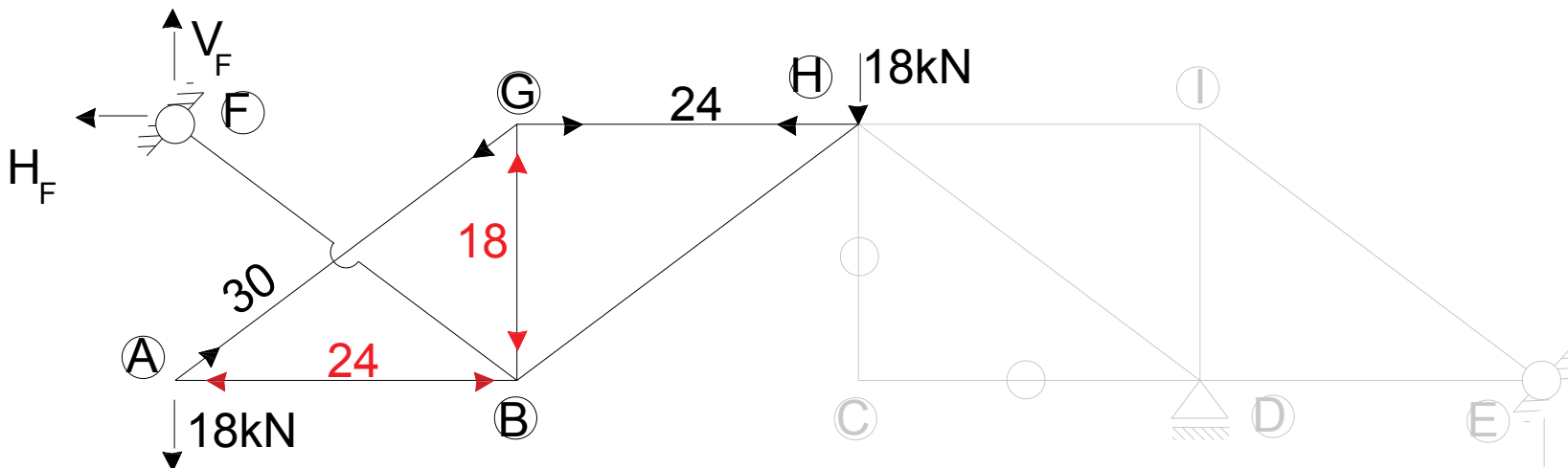

$$\sum M_H^L = -18 \cdot 8 + V_F \cdot 8 = 0 \rightarrow V_F = 18 \text{ kN}$$

## Wykresy: obciążenie zewnętrzne – siły N0 [kN]

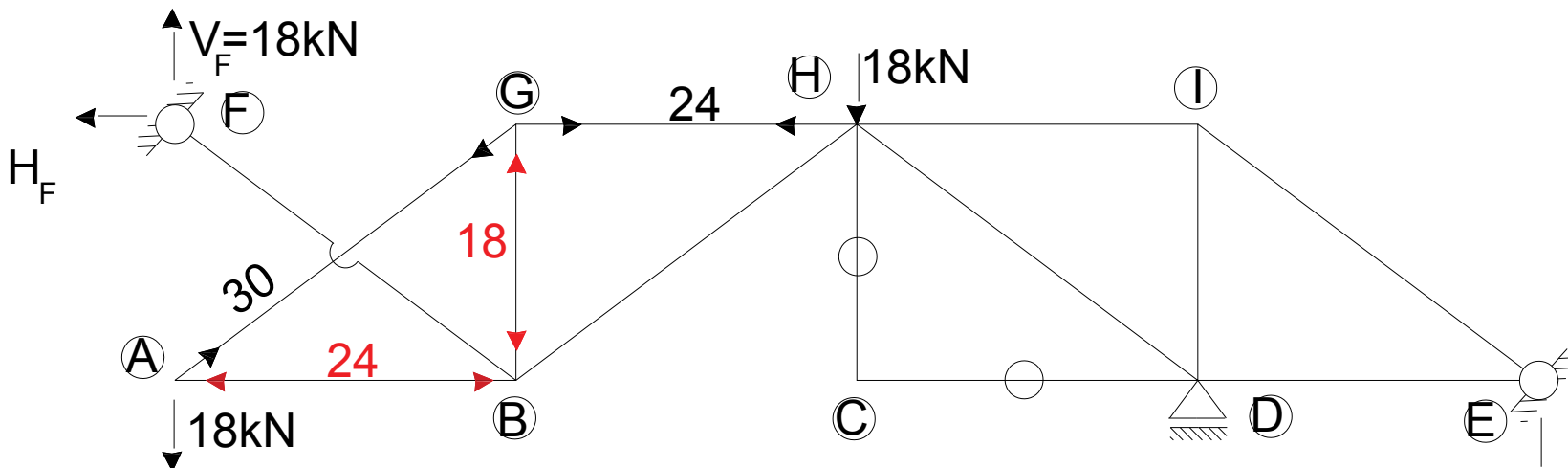

$$\sum M_H^L = -18 \cdot 8 + V_F \cdot 8 = 0 \rightarrow V_F = 18 \text{ kN}$$

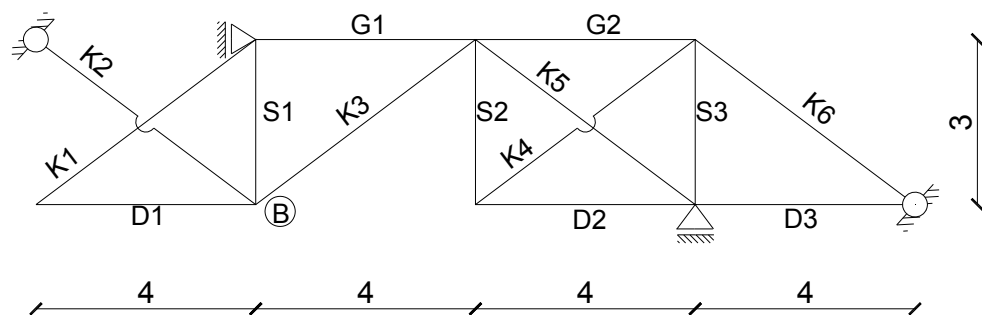

## Wykresy: obciążenie zewnętrzne – siły N0 [kN]

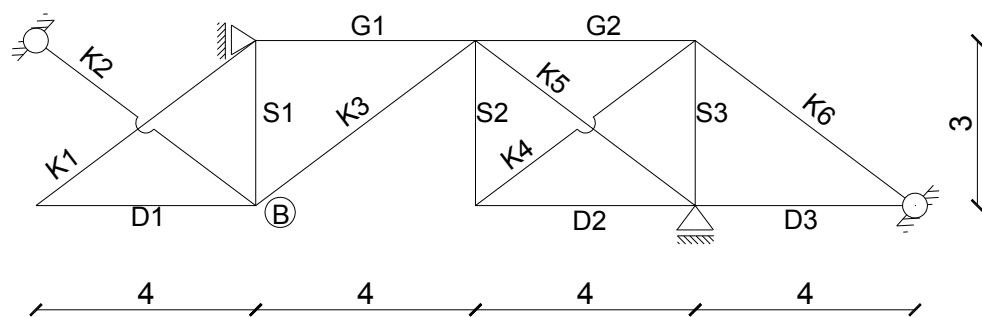
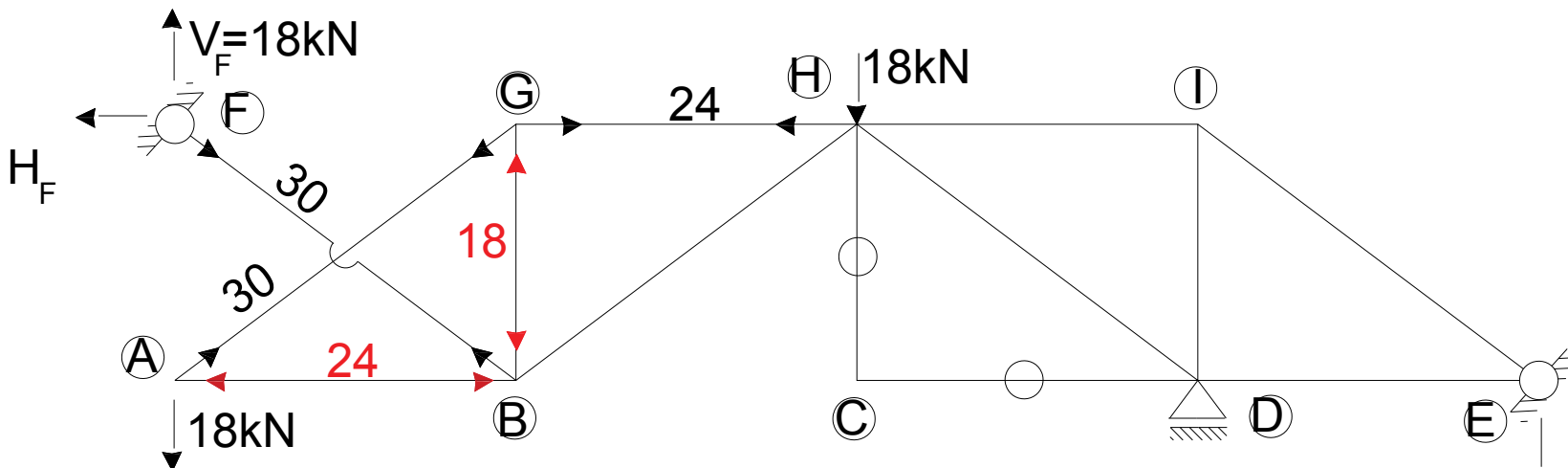

$$\sum M_H^L = -18 \cdot 8 + V_F \cdot 8 = 0 \rightarrow V_F = 18 \text{ kN}$$





## Wykresy: obciążenie zewnętrzne – siły N0 [kN]

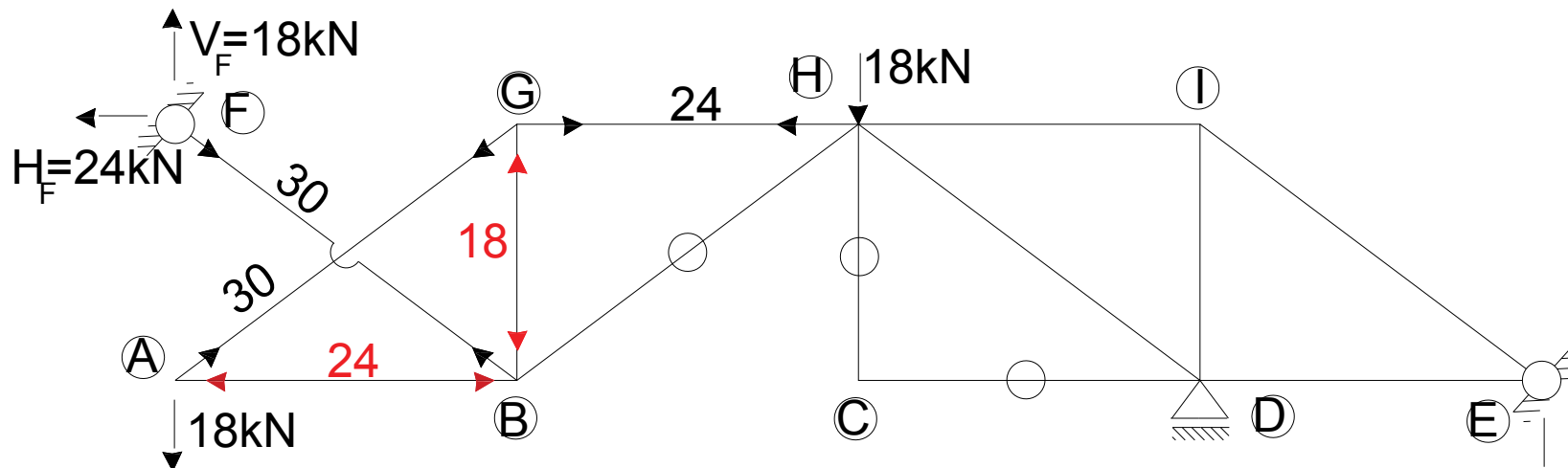

$$\sum M_H^L = -18 \cdot 8 + V_F \cdot 8 = 0 \rightarrow V_F = 18 \text{ kN}$$

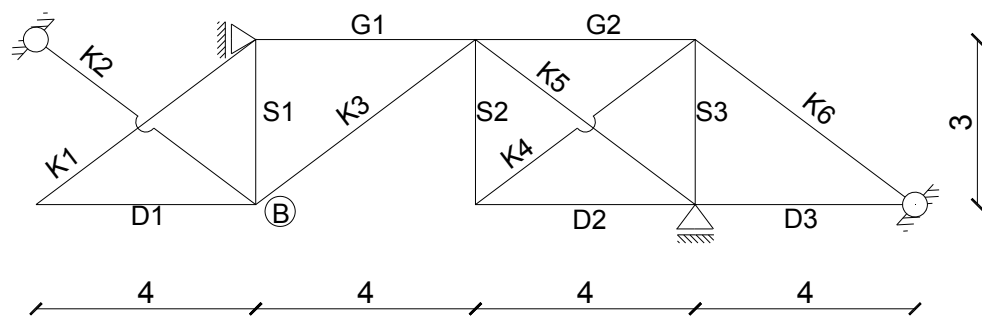

## Wykresy: obciążenie zewnętrzne – siły N0 [kN]

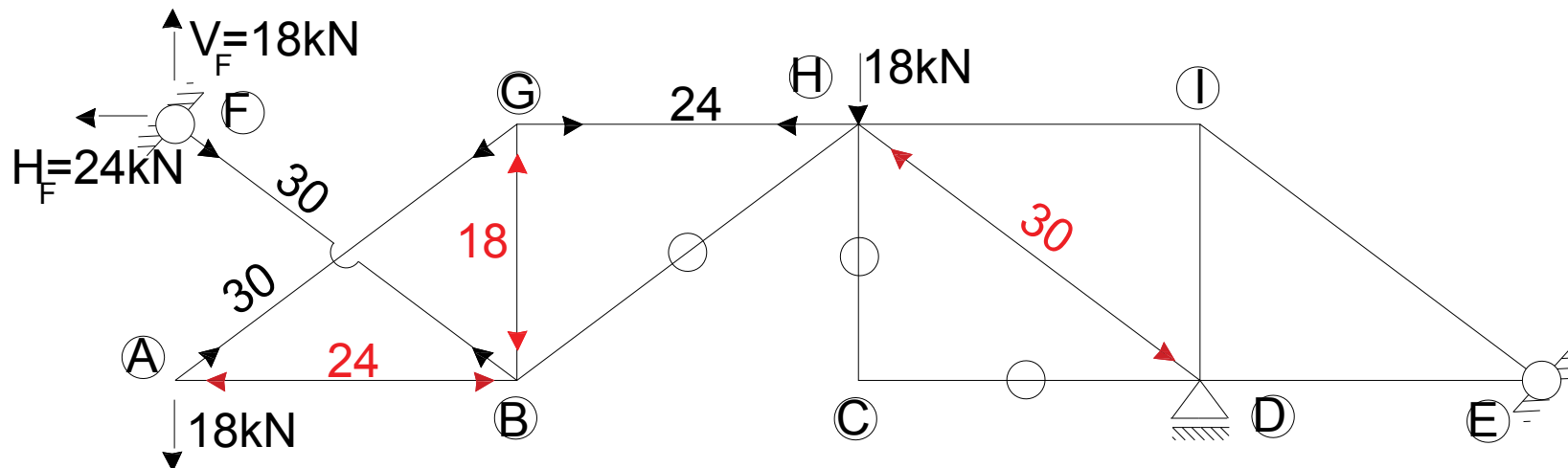

$$\sum M_H^L = -18 \cdot 8 + V_F \cdot 8 = 0 \rightarrow V_F = 18 \text{ kN}$$

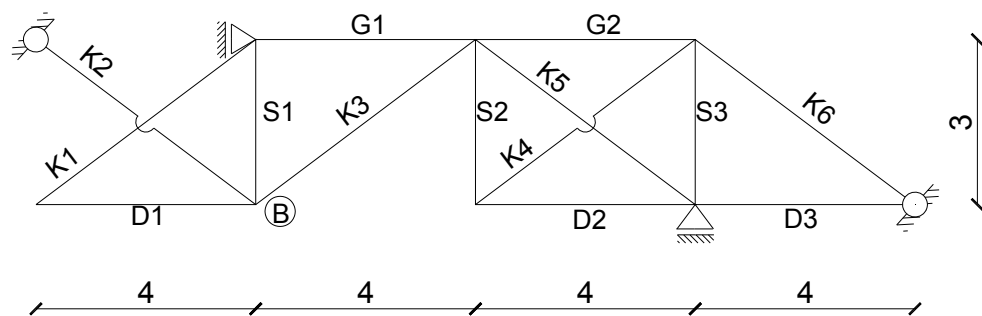

## Wykresy: obciążenie zewnętrzne – siły N0 [kN]

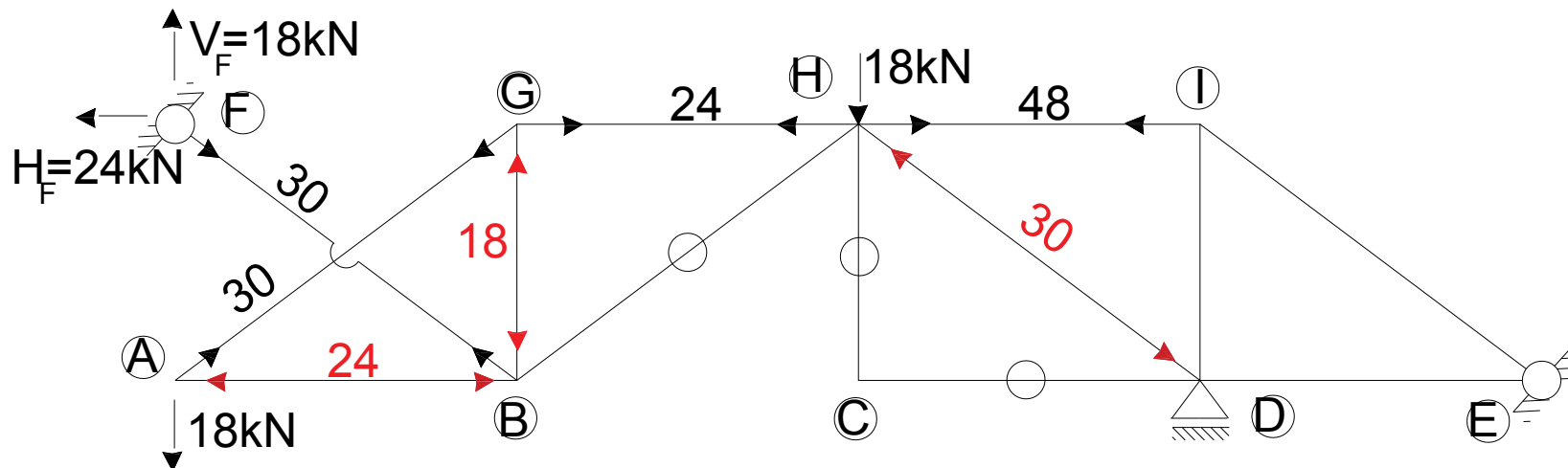

$$\sum M_H^L = -18 \cdot 8 + V_F \cdot 8 = 0 \rightarrow V_F = 18\text{ kN}$$

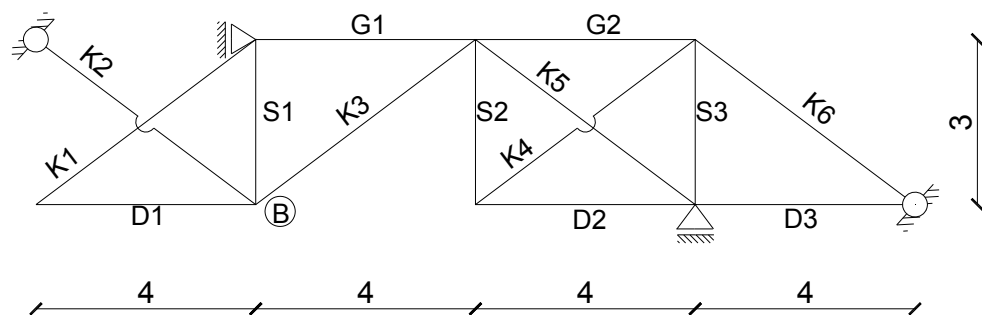

## Wykresy: obciążenie zewnętrzne – siły N0 [kN]

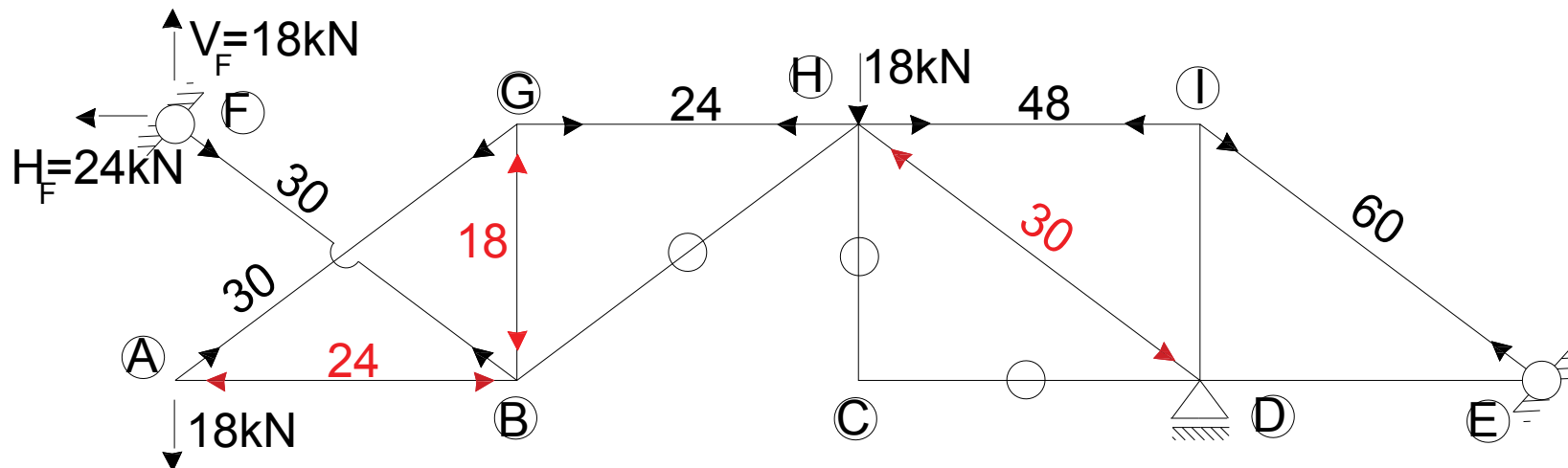

$$\sum M_H^L = -18 \cdot 8 + V_F \cdot 8 = 0 \rightarrow V_F = 18 \text{ kN}$$

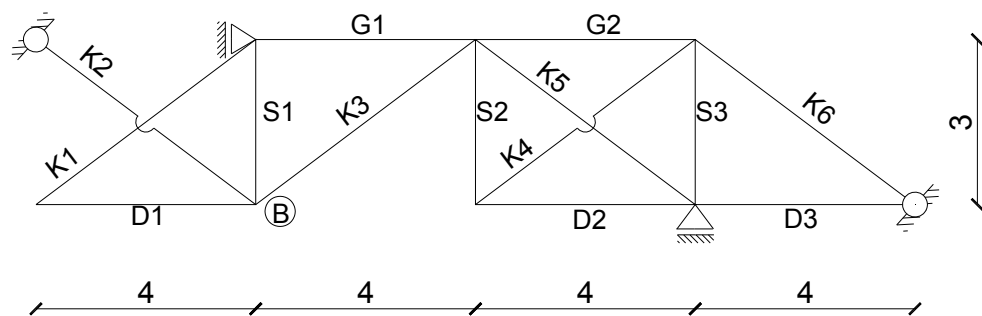

## Wykresy: obciążenie zewnętrzne – siły N0 [kN]

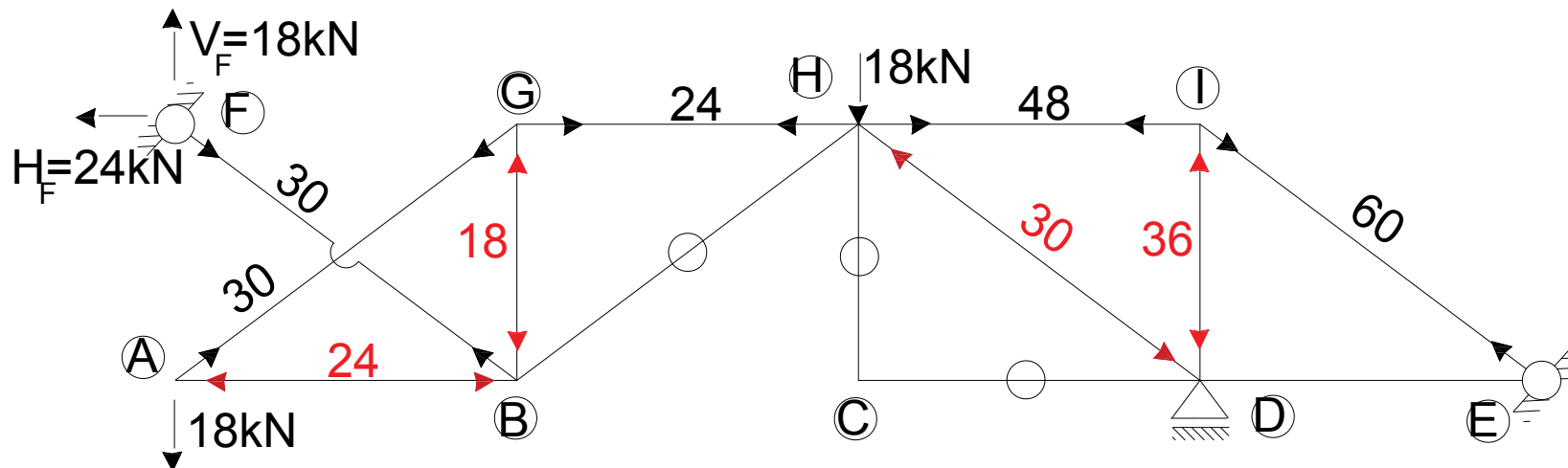

$$\sum M_H^L = -18 \cdot 8 + V_F \cdot 8 = 0 \rightarrow V_F = 18\text{ kN}$$

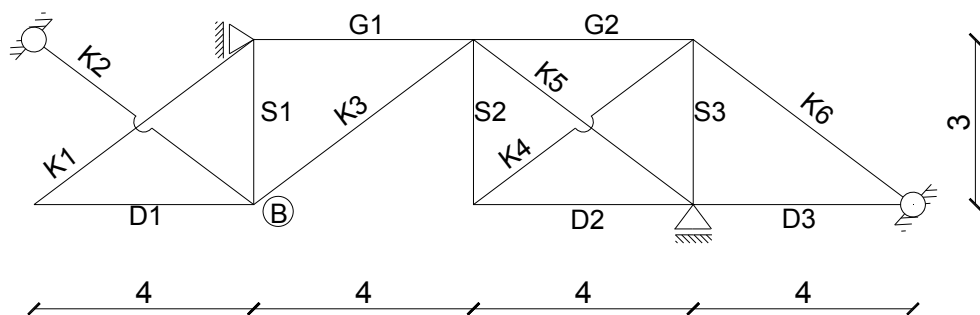

## Wykresy: obciążenie zewnętrzne – siły N0 [kN]

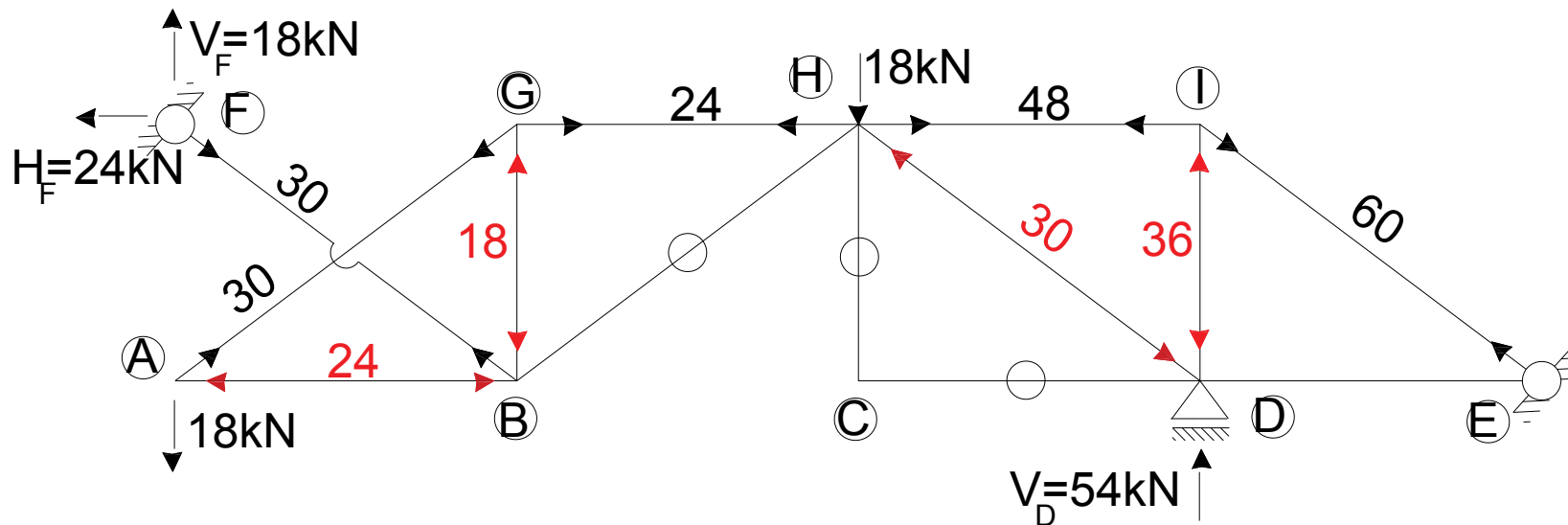

$$\sum M_H^L = -18 \cdot 8 + V_F \cdot 8 = 0 \rightarrow V_F = 18 \text{ kN}$$

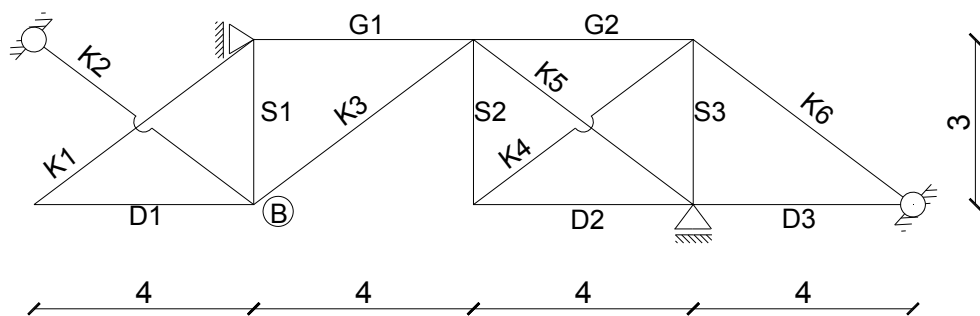

## Wykresy: obciążenie zewnętrzne – siły N0 [kN]

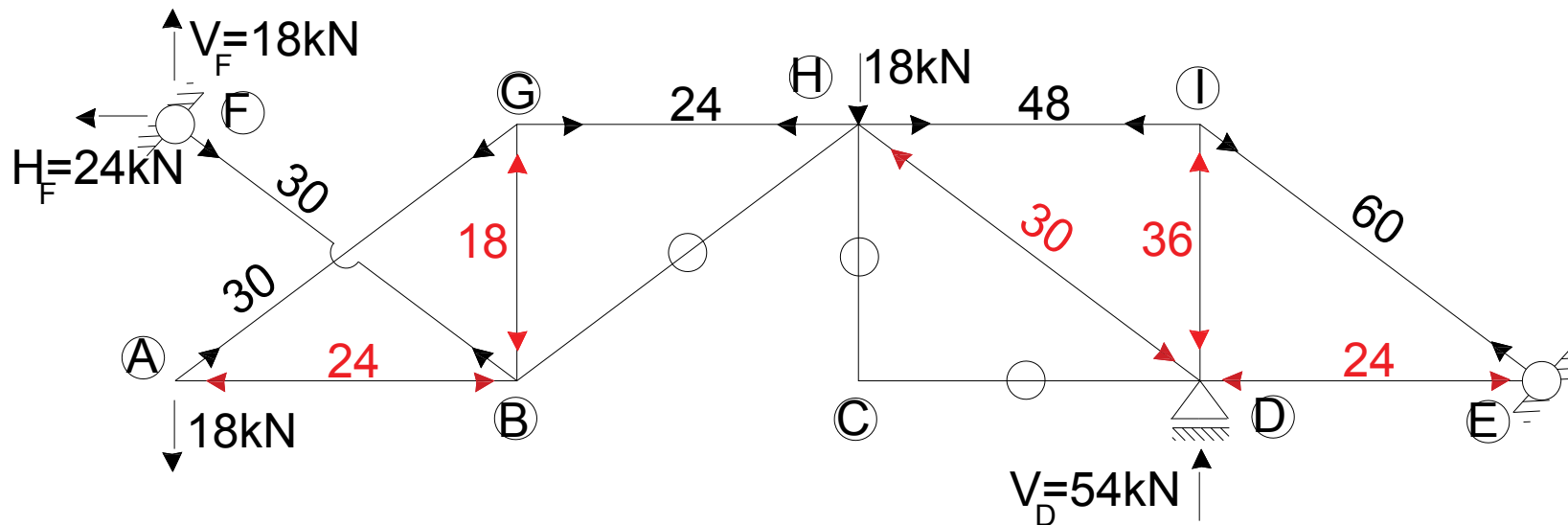

$$\sum M_H^L = -18 \cdot 8 + V_F \cdot 8 = 0 \rightarrow V_F = 18\text{ kN}$$

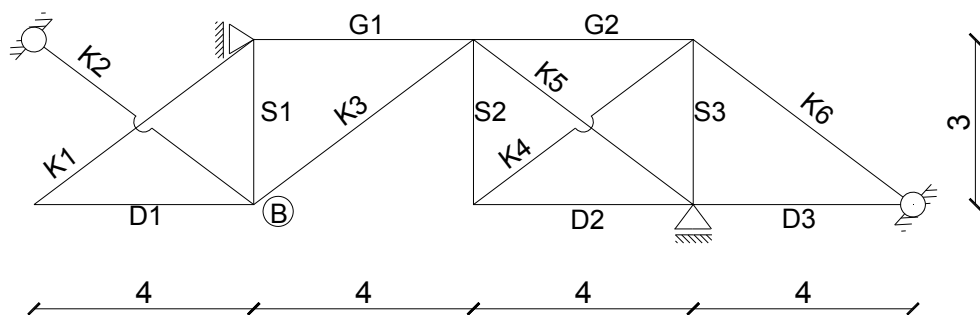

## Wykresy: obciążenie zewnętrzne – siły N0 [kN]

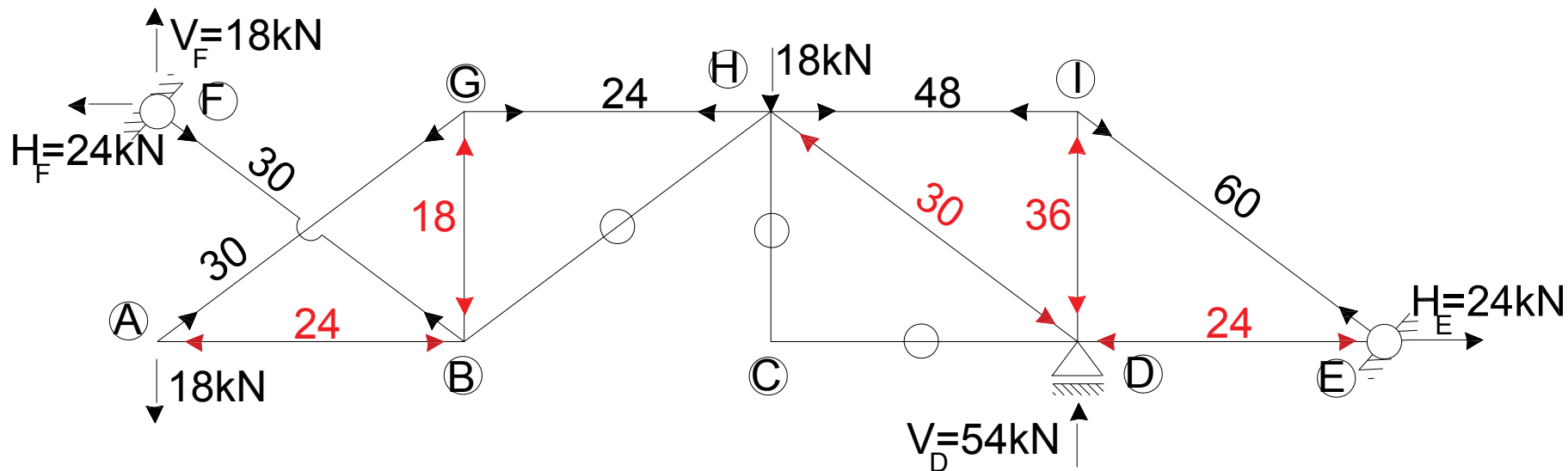

$$\sum M_H^L = -18 \cdot 8 + V_F \cdot 8 = 0 \rightarrow V_F = 18 \text{ kN}$$

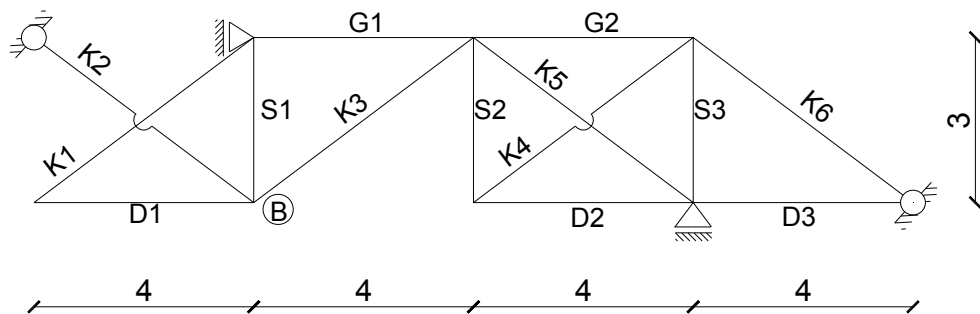



## Wykresy: obciążenie zewnętrzne – siły N0 [kN]

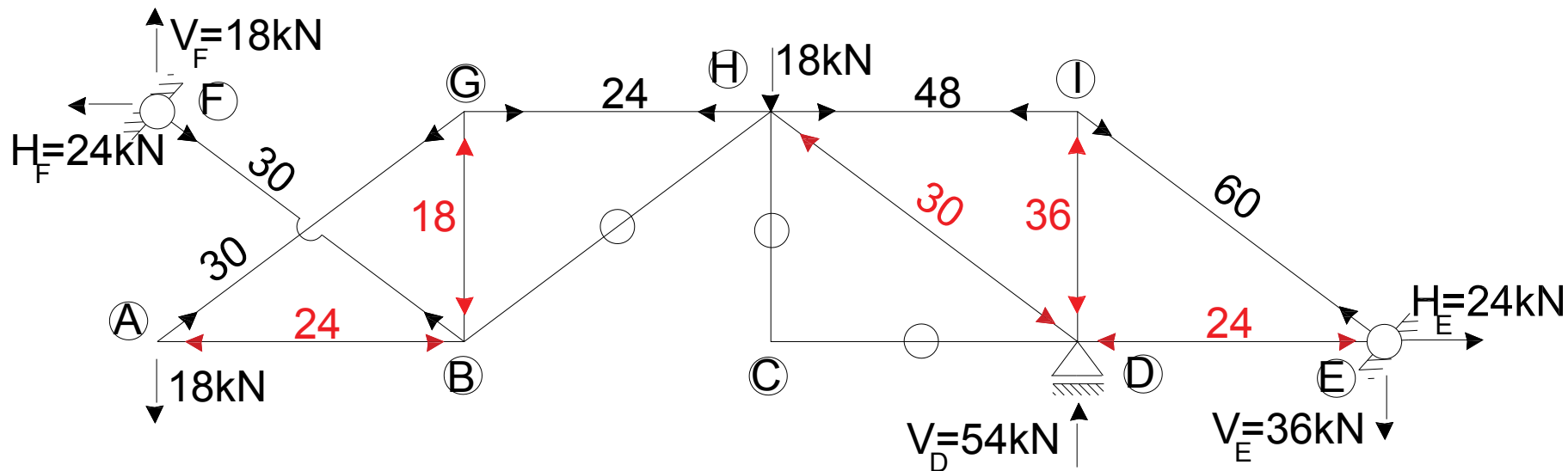

$$\sum M_H^L = -18 \cdot 8 + V_F \cdot 8 = 0 \rightarrow V_F = 18 \text{ kN}$$

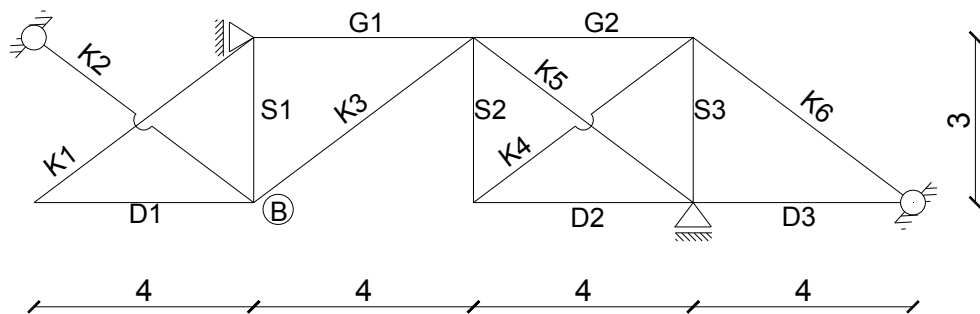

## Wykresy: obciążenie zewnętrzne – siły N0 [kN]

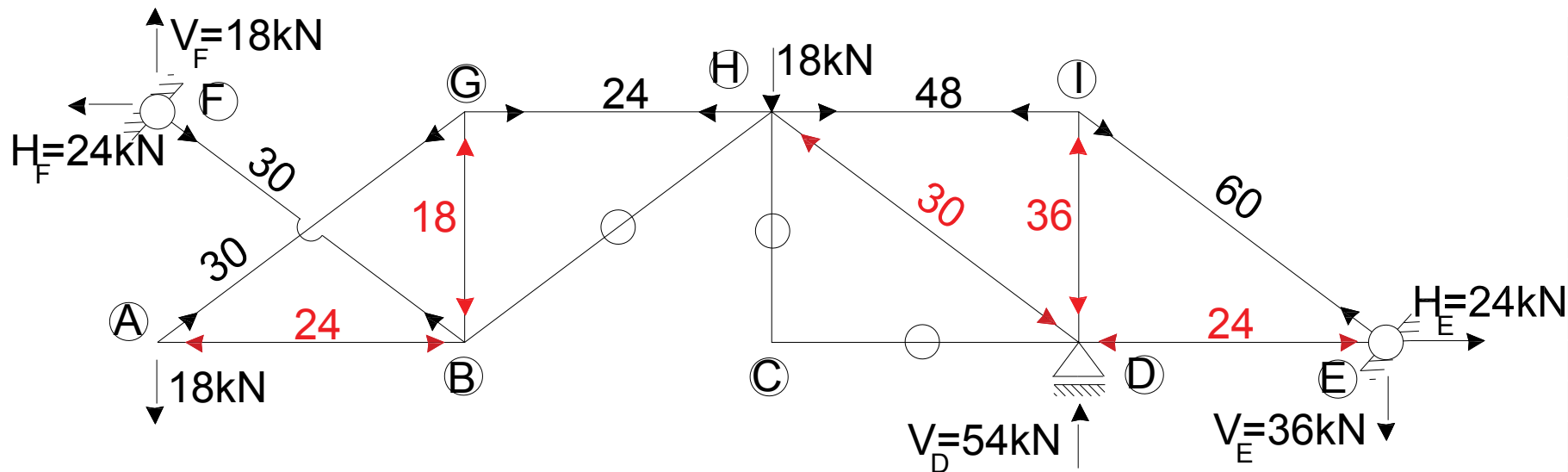

Pręt	L/EA	N0
D1	4	-24
D2	4	0
D3	4	-24
G1	4	24
G2	4	48
S1	3	-18
S2	3	0
S3	3	-36
K1	2,5	30
K2	2,5	30
K3	2,5	0
K4	2,5	0
K5	2,5	-30
K6	2,5	60

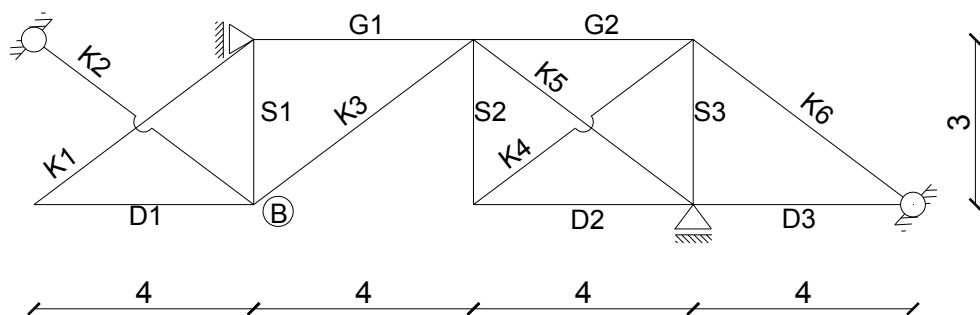

## Obliczenia metody sił:

Pręt	L/EA	N1	N2	N0	$\frac{N1 \cdot N1 \cdot L}{EA}$	$\frac{N1 \cdot N2 \cdot L}{EA}$	$\frac{N2 \cdot N2 \cdot L}{EA}$	$\frac{N1 \cdot N0 \cdot L}{EA}$	$\frac{N2 \cdot N0 \cdot L}{EA}$	N1*X1	N2*X2	N	$\frac{N1 \cdot N \cdot L}{EA}$	$\frac{N2 \cdot N \cdot L}{EA}$
					EA	EA	EA	EA	EA				EA	
D1	4	0	0	-24	0	0	0	0	0	0,000	0,000	-24,000	0,000	0,000
D2	4	-0,8	0	0	2,56	0	0	0	0	-5,857	0,000	-5,857	18,743	0,000
D3	4	0	0	-24	0	0	0	0	0	0,000	0,000	-24,000	0,000	0,000
G1	4	0	-1	24	0	0	4	0	-96	0,000	-39,942	-15,942	0,000	63,766
G2	4	-0,8	-1	48	2,56	3,2	4	-153,6	-192	-5,857	-39,942	2,201	-7,044	-8,805
S1	3	0	0	-18	0	0	0	0	0	0,000	0,000	-18,000	0,000	0,000
S2	3	-0,6	0	0	1,08	0	0	0	0	-4,393	0,000	-4,393	7,907	0,000
S3	3	-0,6	0,75	-36	1,08	-1,35	1,6875	64,8	-81	-4,393	29,956	-10,437	18,786	-23,483
K1	2,5	0	0	30	0	0	0	0	0	0,000	0,000	30,000	0,000	0,000
K2	2,5	0	0	30	0	0	0	0	0	0,000	0,000	30,000	0,000	0,000
K3	2,5	0	0	0	0	0	0	0	0	0,000	0,000	0,000	0,000	0,000
K4	2,5	1	0	0	2,5	0	0	0	0	7,322	0,000	7,322	18,304	0,000
K5	2,5	1	0	-30	2,5	0	0	-75	0	7,322	0,000	-22,678	-56,696	0,000
K6	2,5	0	-1,25	60	0	0	3,90625	0	-187,5	0,000	-49,927	10,073	0,000	-31,478
					12,28	1,85	13,594	-163,8	-556,5				0,000	0,000

Układ równań metody sił:

$\delta_{11}$        $\delta_{12}$        $\delta_{22}$        $\delta_{10}$        $\delta_{20}$

$$\delta_{11} \cdot x_1 + \delta_{12} \cdot x_2 + \delta_{10} = 0$$



$$12,28 \cdot x_1 + 1,85 \cdot x_2 - 163,8 = 0$$



$$x_1 = 7,322 \text{ kN}$$

$$\delta_{21} \cdot x_1 + \delta_{22} \cdot x_2 + \delta_{20} = 0$$

$$1,85 \cdot x_1 + 13,594 \cdot x_2 - 556,5 = 0$$

$$x_2 = 39,942 \text{ kN}$$

# Końcowy wykres sił normalnych – N [kN]

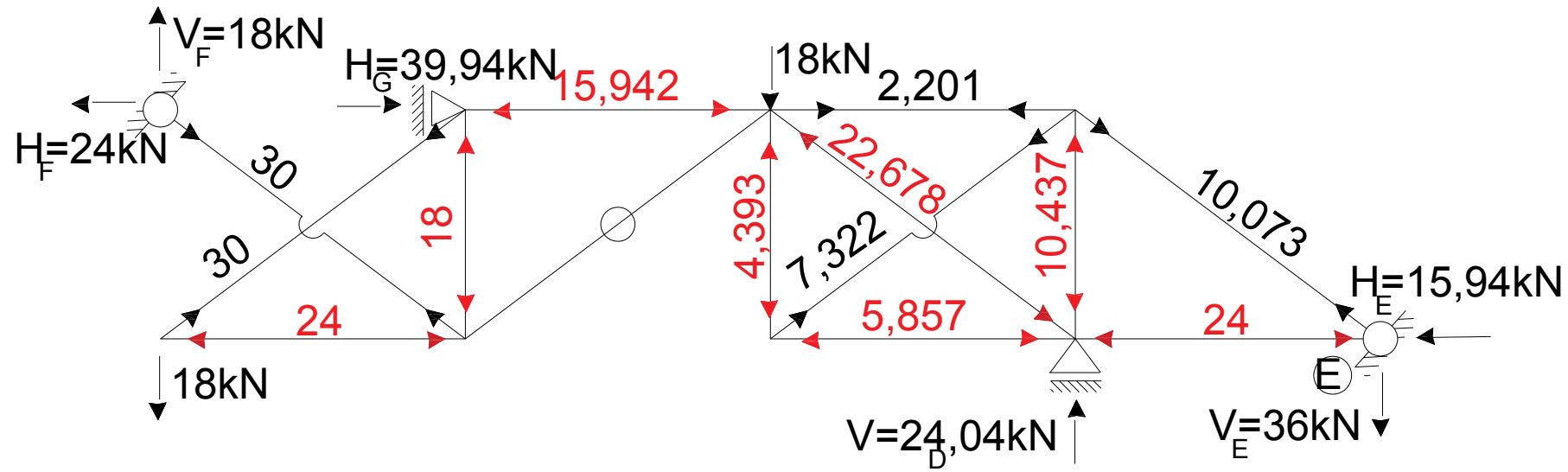

Pręt	L/EA	N
D1	4	-24,000
D2	4	-5,857
D3	4	-24,000
G1	4	-15,942
G2	4	2,201
S1	3	-18,000
S2	3	-4,393
S3	3	-10,437
K1	2,5	30,000
K2	2,5	30,000
K3	2,5	0,000
K4	2,5	7,322
K5	2,5	-22,678
K6	2,5	10,073

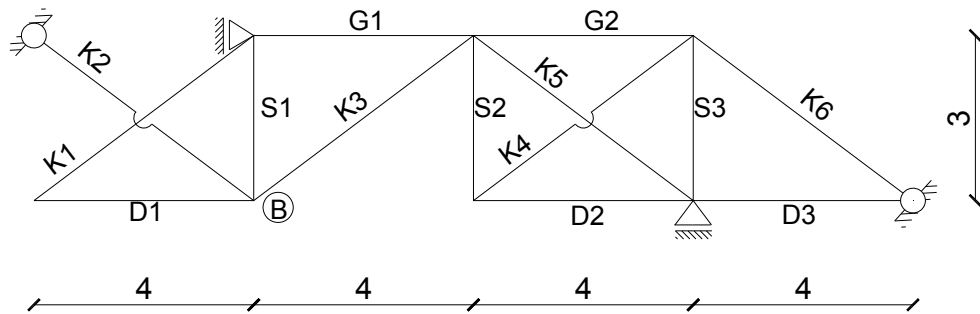

# Obliczenie przemieszczenia pionowego punktu B z twierdzenia redukcyjnego:

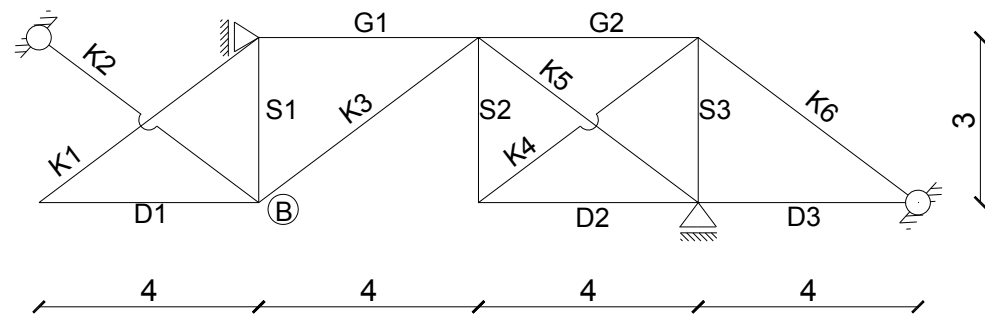
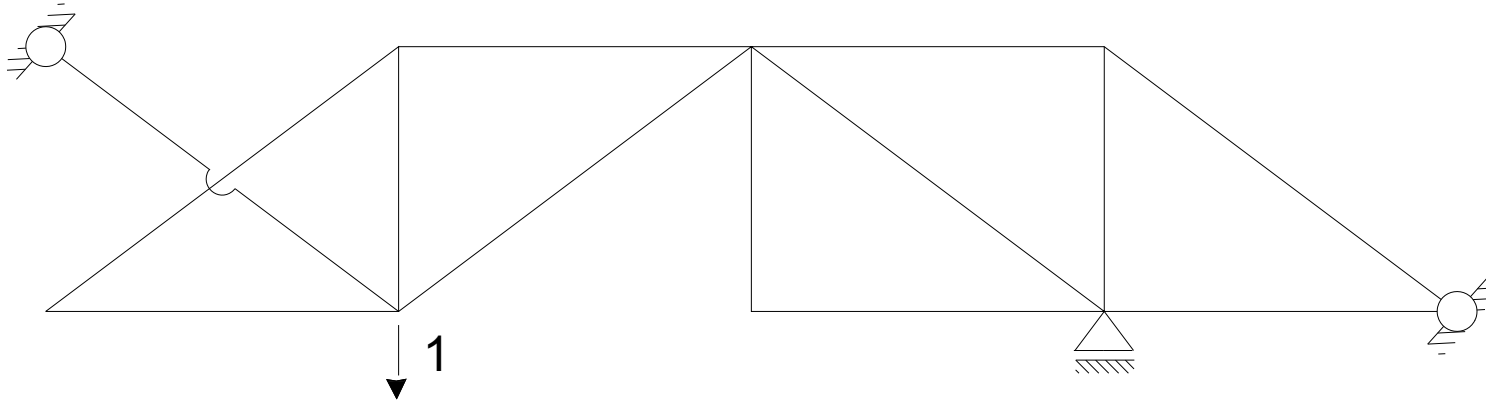

# Obliczenie przemieszczenia pionowego punktu B z twierdzenia redukcyjnego:

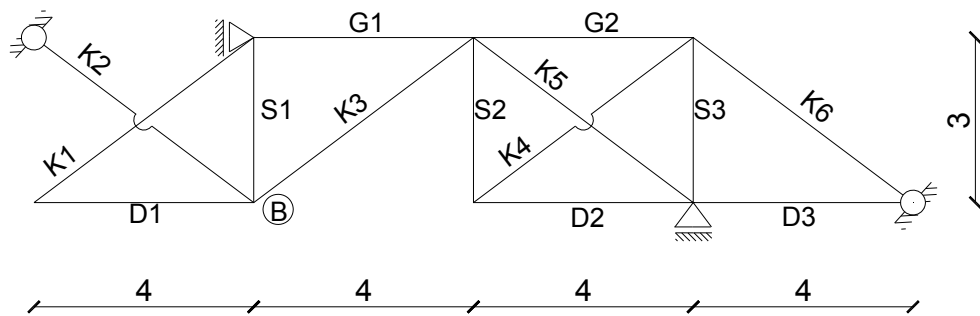
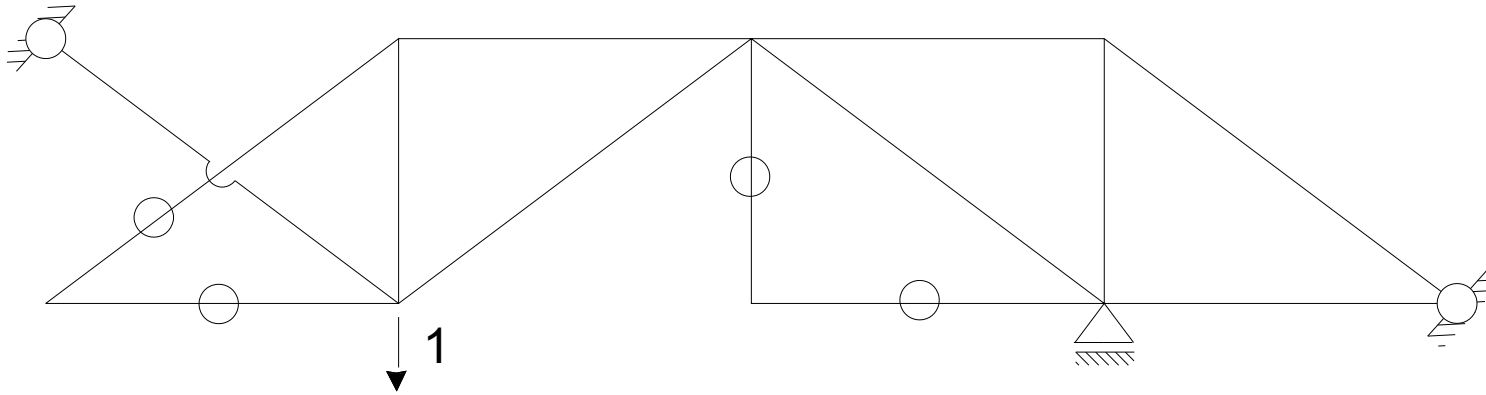

## Obliczenie przemieszczenia pionowego punktu B z twierdzenia redukcyjnego:

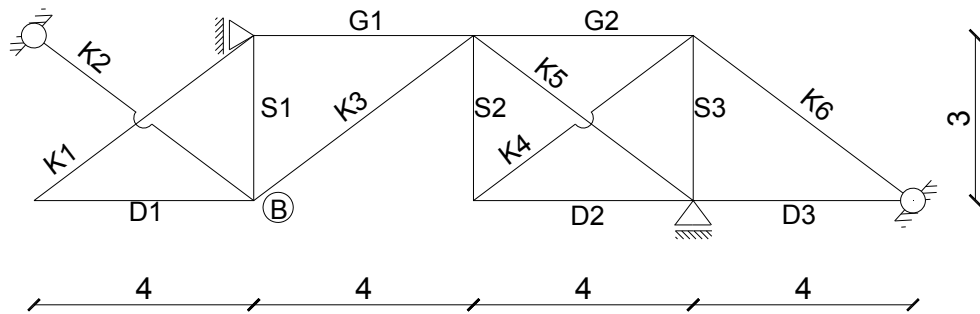
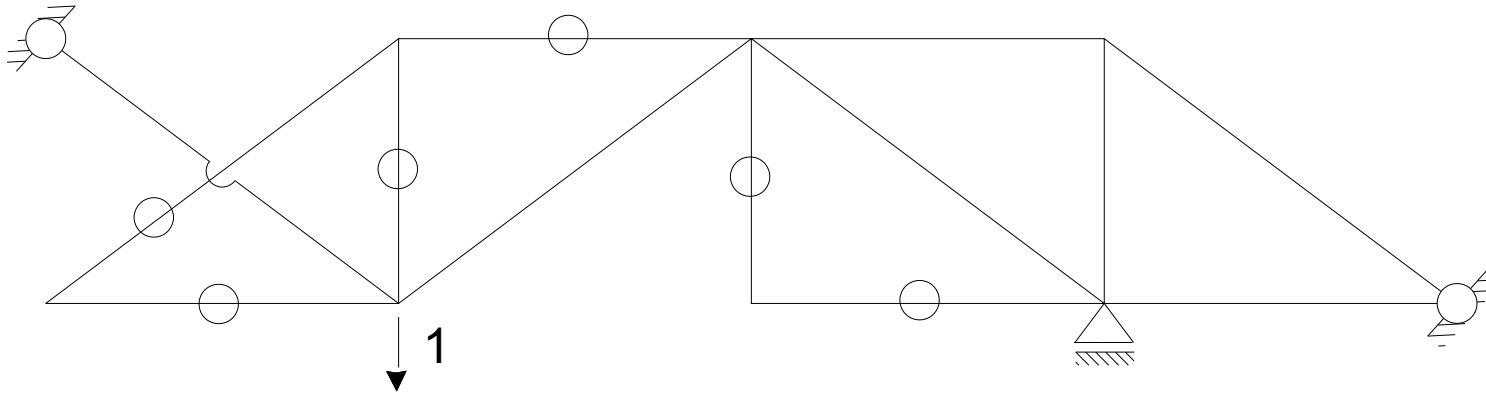

# Obliczenie przemieszczenia pionowego punktu B z twierdzenia redukcyjnego:

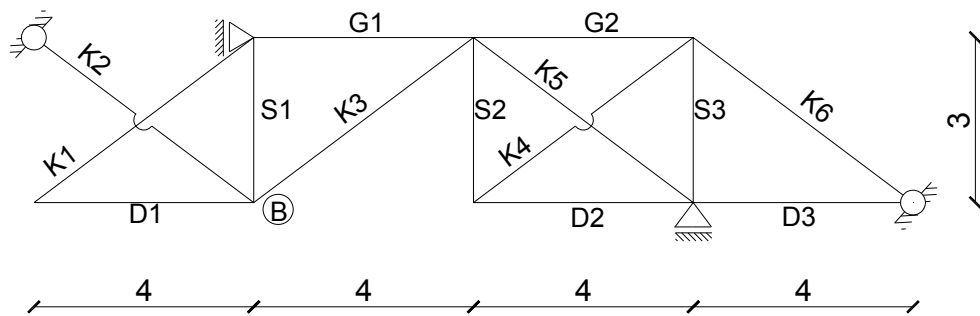
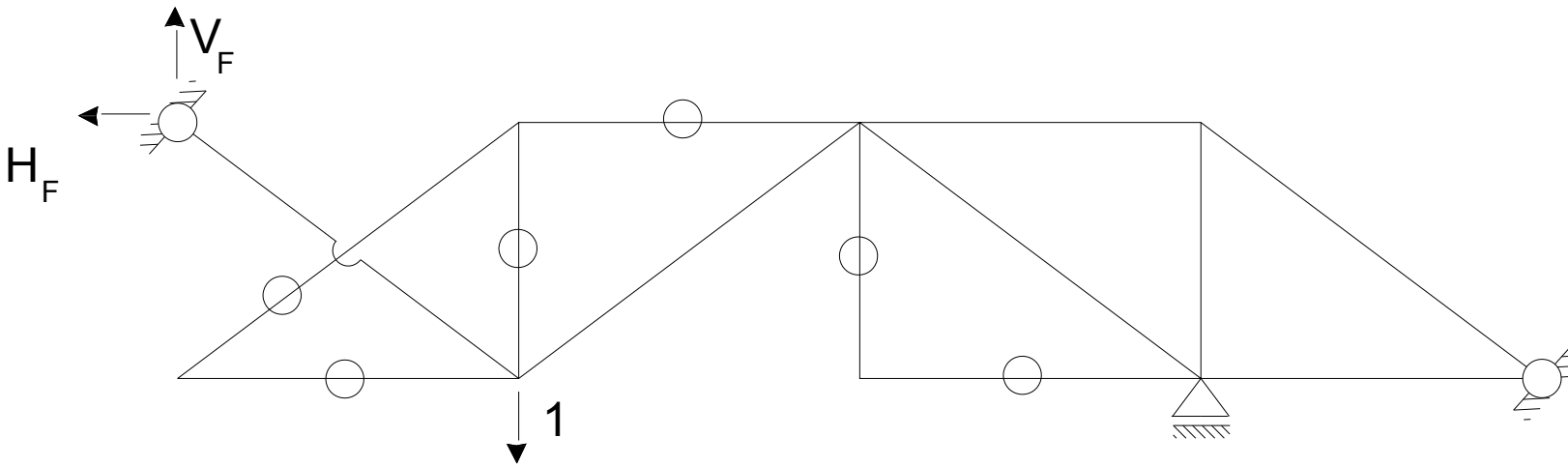



# Obliczenie przemieszczenia pionowego punktu B z twierdzenia redukcyjnego:

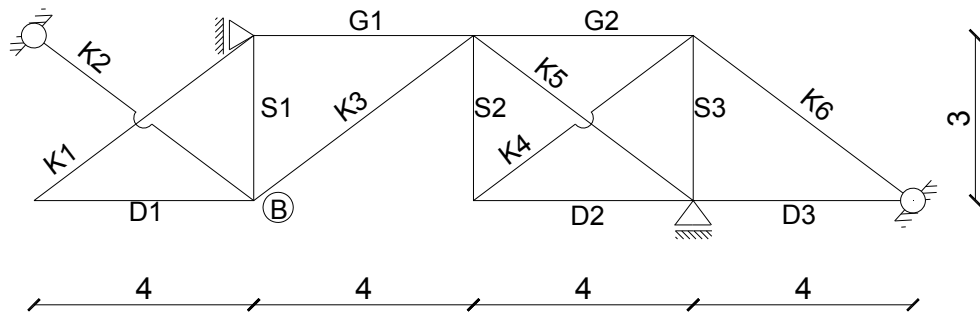
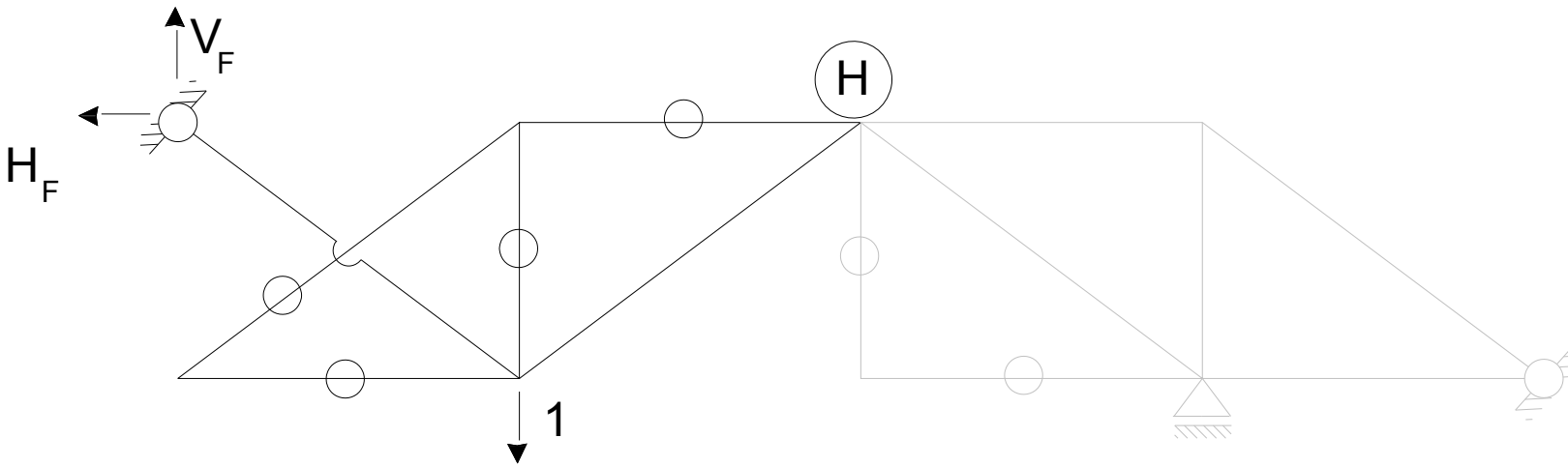

## Obliczenie przemieszczenia pionowego punktu B z twierdzenia redukcyjnego:

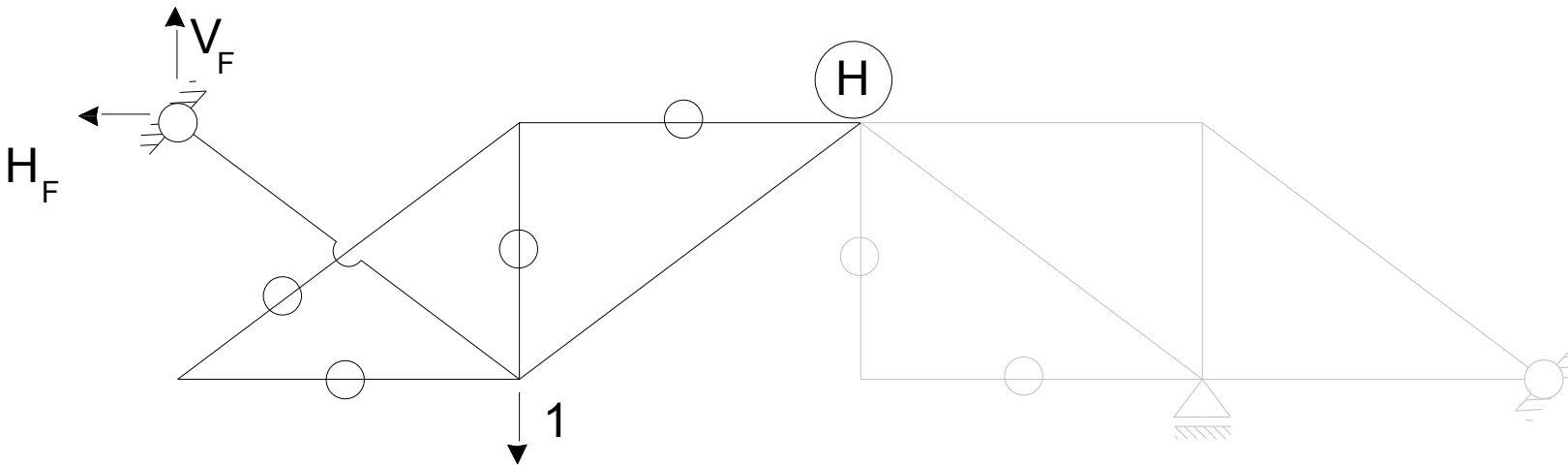

$$\sum M_H^L = -1 \cdot 4 - V_F \cdot 8 = 0 \rightarrow V_F = 0,5$$

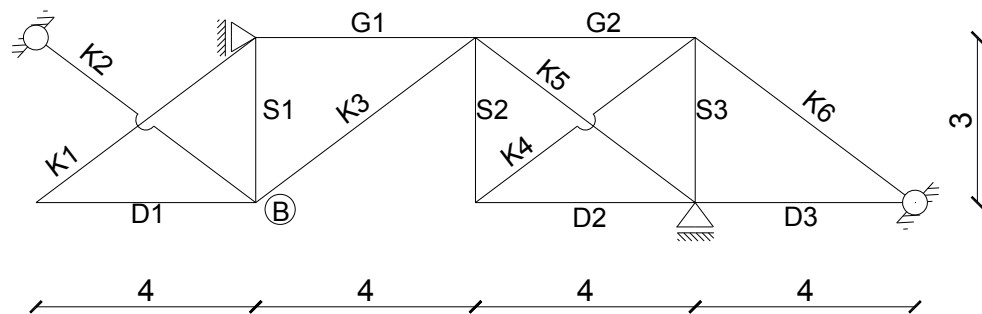

## Obliczenie przemieszczenia pionowego punktu B z twierdzenia redukcyjnego:

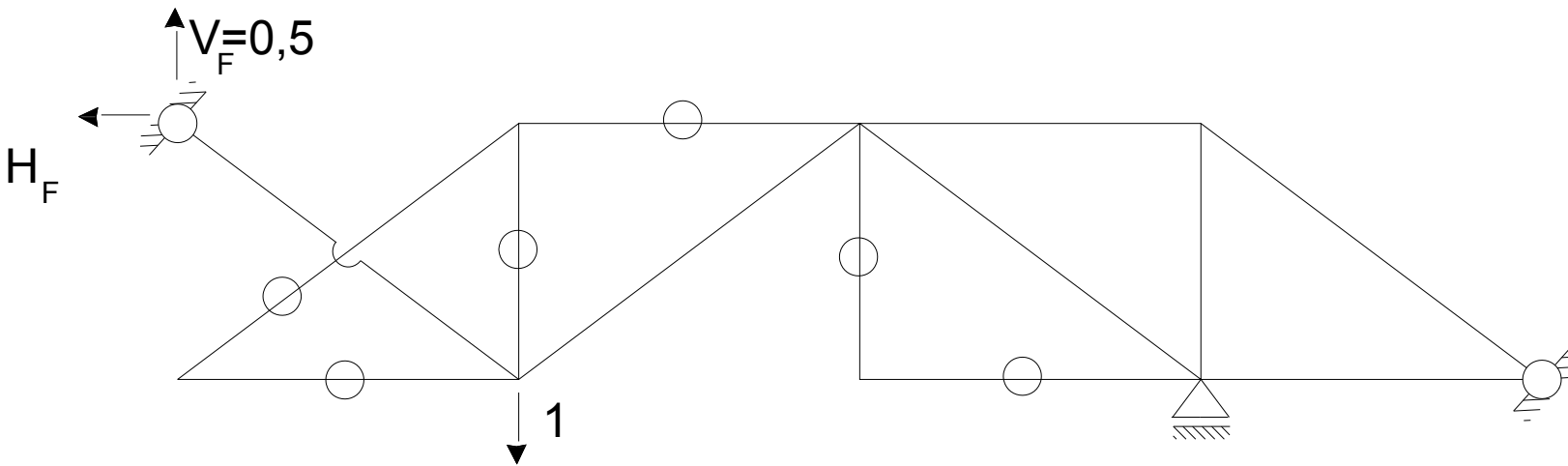

$$\sum M_H^L = -1 \cdot 4 - V_F \cdot 8 = 0 \rightarrow V_F = 0,5$$

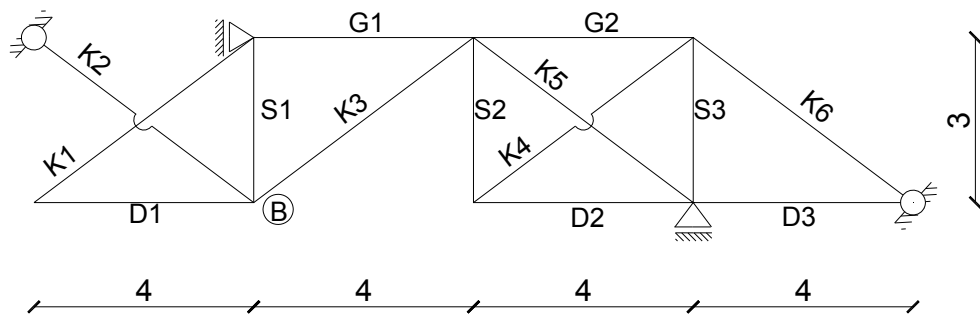

## Obliczenie przemieszczenia pionowego punktu B z twierdzenia redukcyjnego:

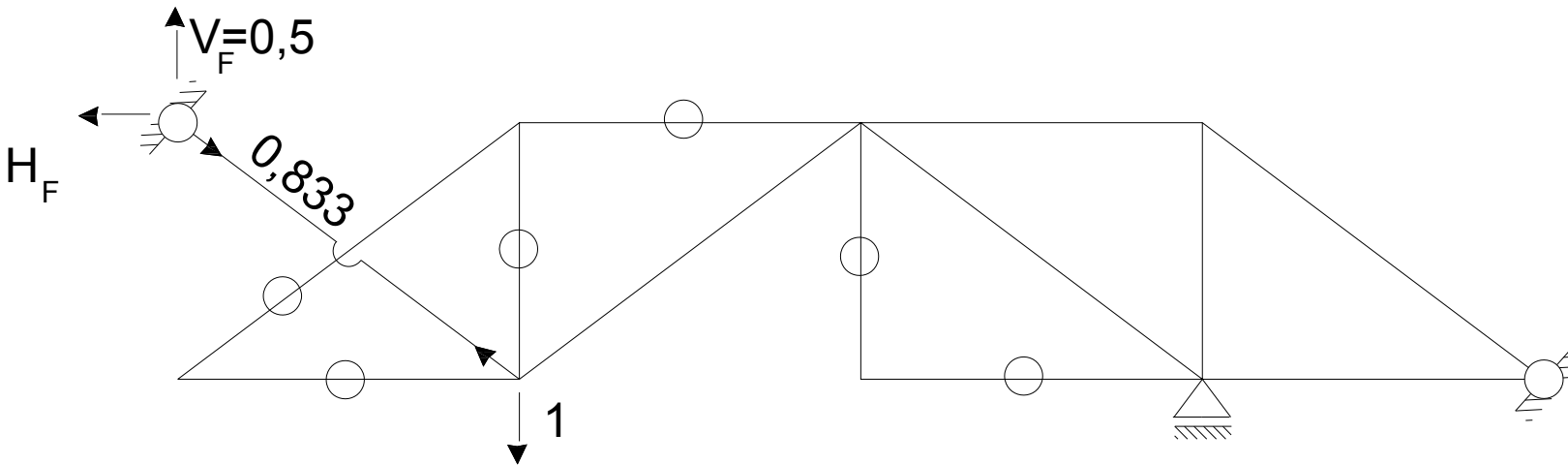

$$\sum M_H^L = -1 \cdot 4 - V_F \cdot 8 = 0 \rightarrow V_F = 0,5$$

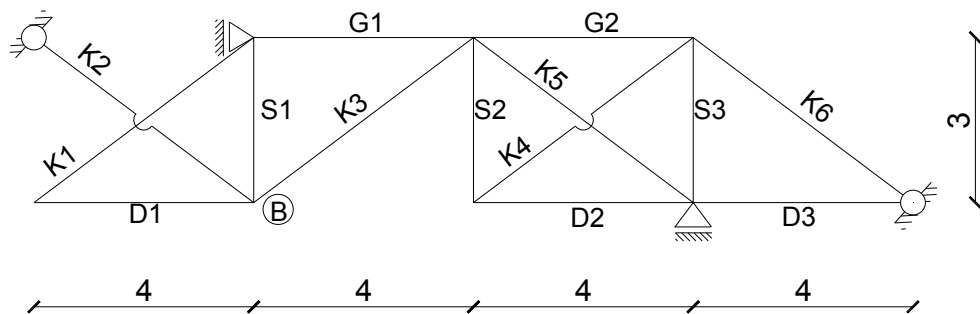

## Obliczenie przemieszczenia pionowego punktu B z twierdzenia redukcyjnego:

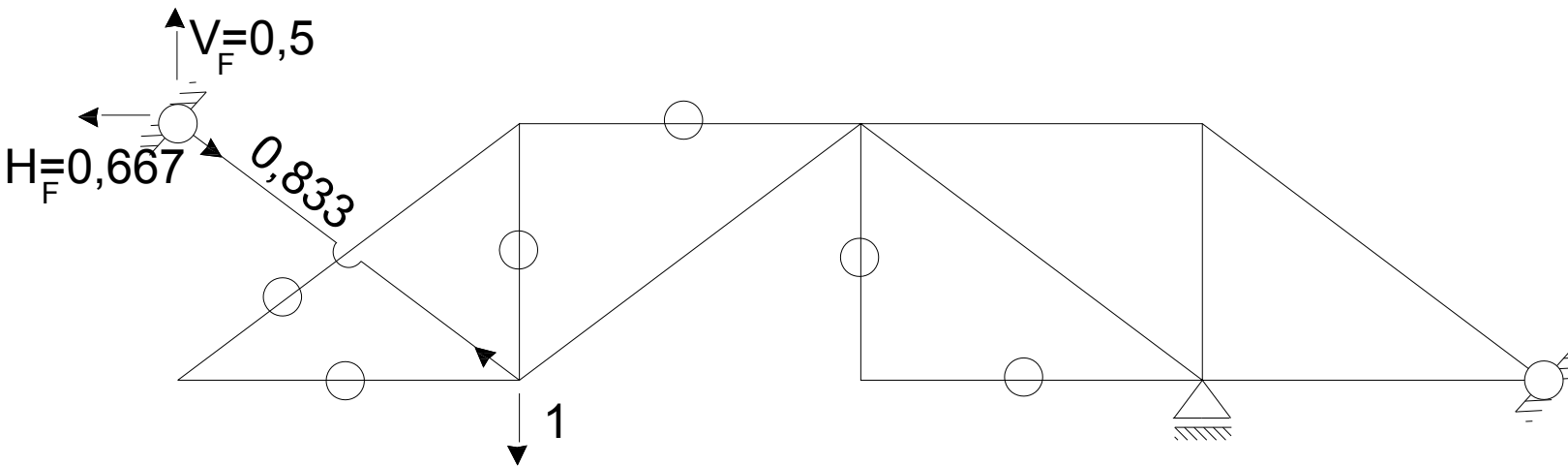

$$\sum M_H^L = -1 \cdot 4 - V_F \cdot 8 = 0 \rightarrow V_F = 0,5$$

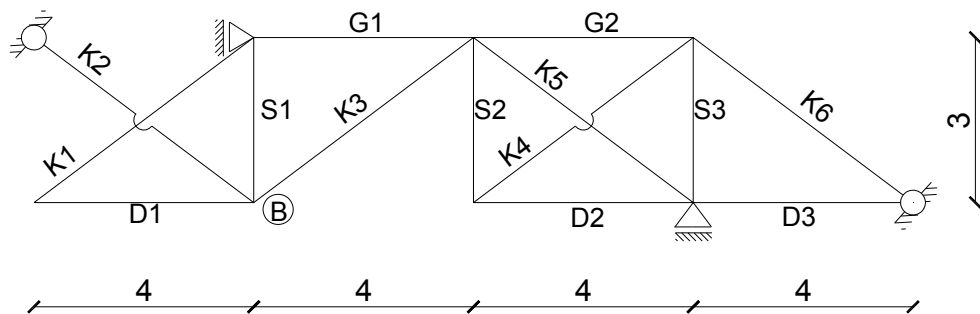

## Obliczenie przemieszczenia pionowego punktu B z twierdzenia redukcyjnego:

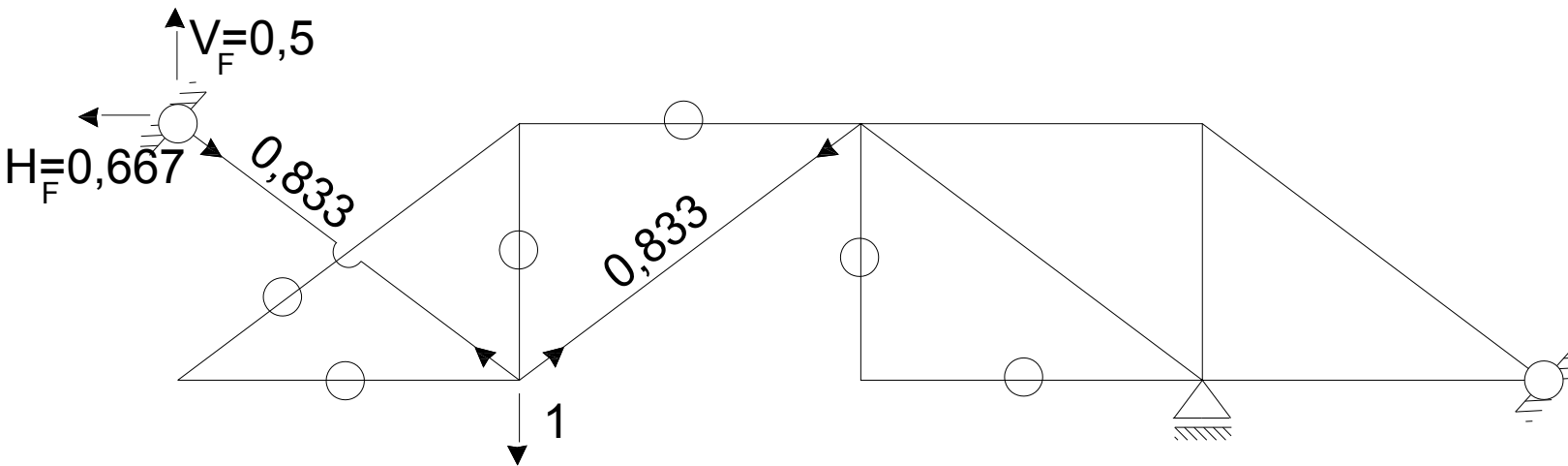

$$\sum M_H^L = -1 \cdot 4 - V_F \cdot 8 = 0 \rightarrow V_F = 0,5$$

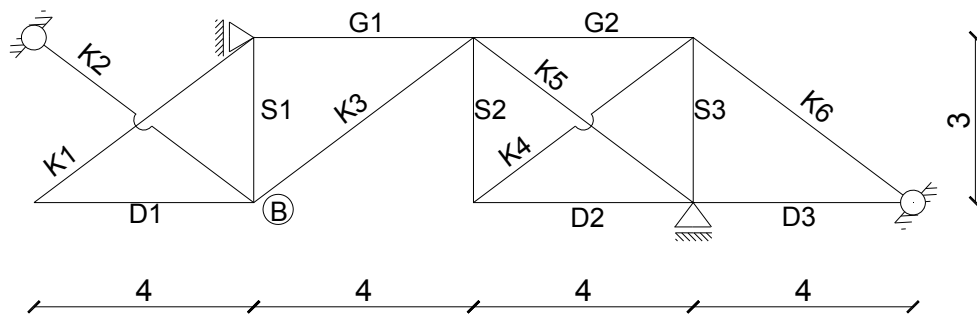

## Obliczenie przemieszczenia pionowego punktu B z twierdzenia redukcyjnego:

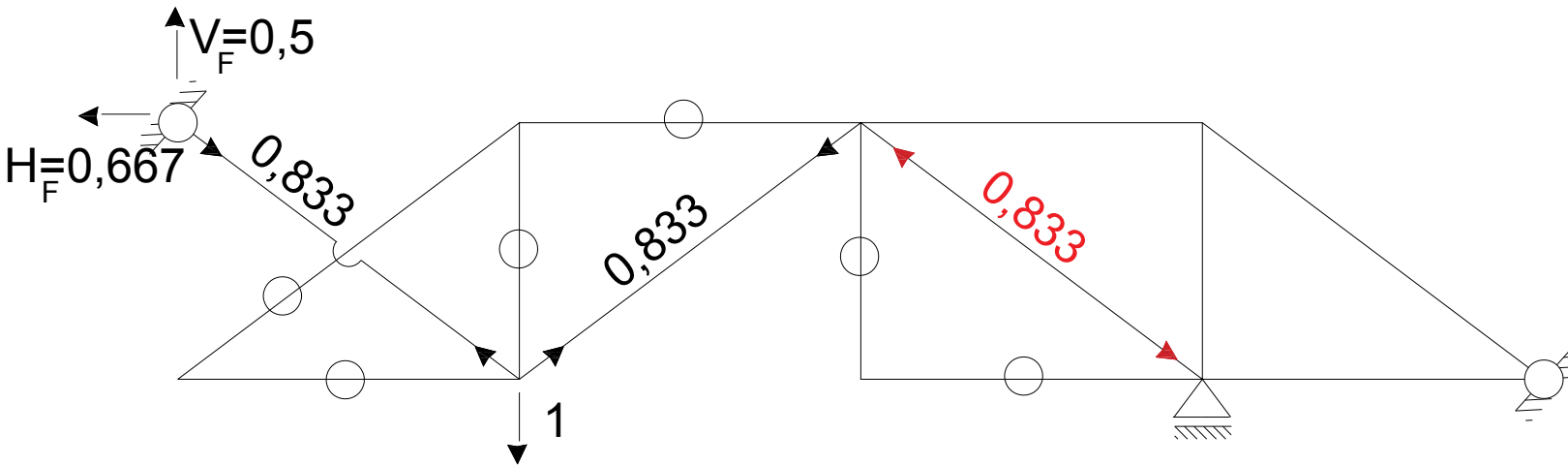

$$\sum M_H^L = -1 \cdot 4 - V_F \cdot 8 = 0 \rightarrow V_F = 0,5$$

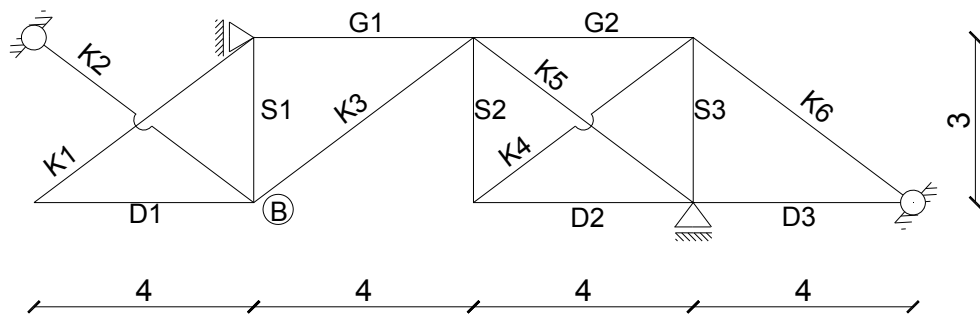

## Obliczenie przemieszczenia pionowego punktu B z twierdzenia redukcyjnego:

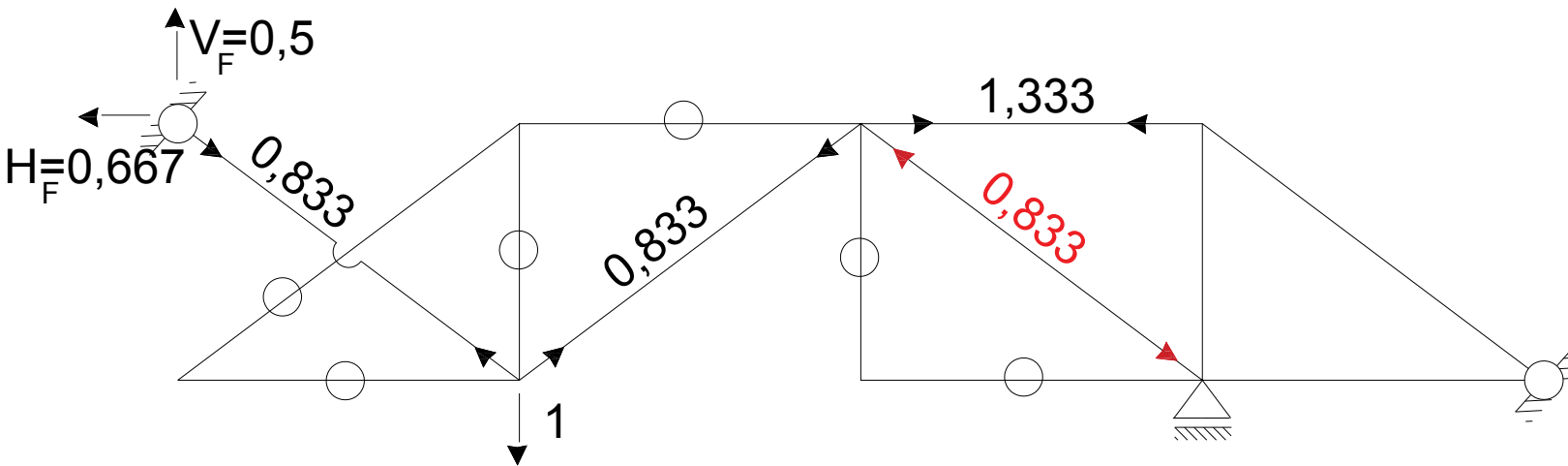

$$\sum M_H^L = -1 \cdot 4 - V_F \cdot 8 = 0 \rightarrow V_F = 0,5$$

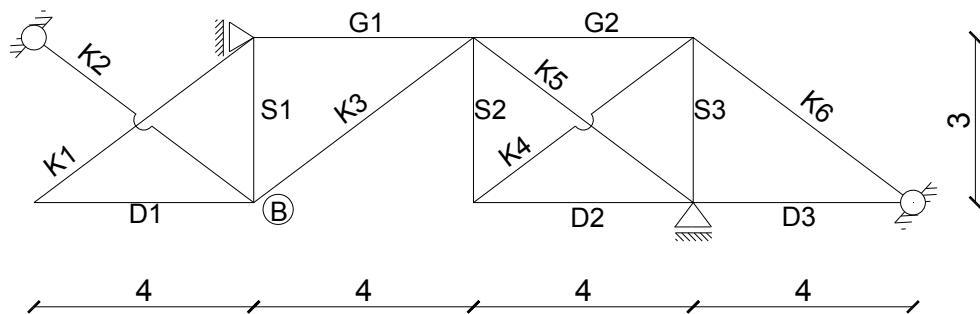



## Obliczenie przemieszczenia pionowego punktu B z twierdzenia redukcyjnego:

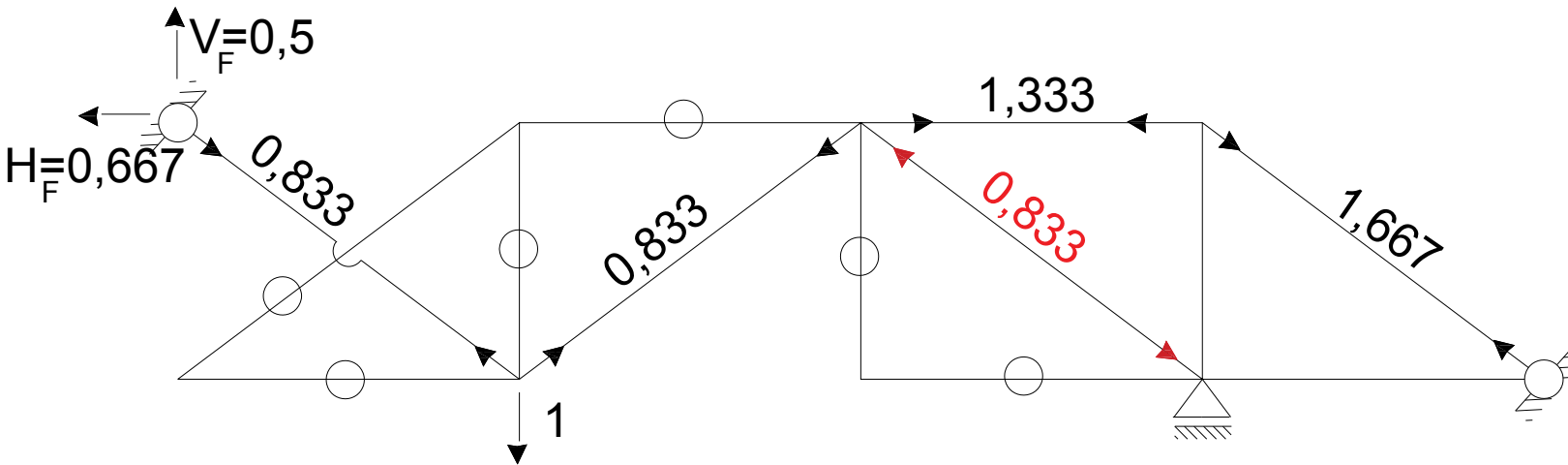

$$\sum M_H^L = -1 \cdot 4 - V_F \cdot 8 = 0 \rightarrow V_F = 0,5$$

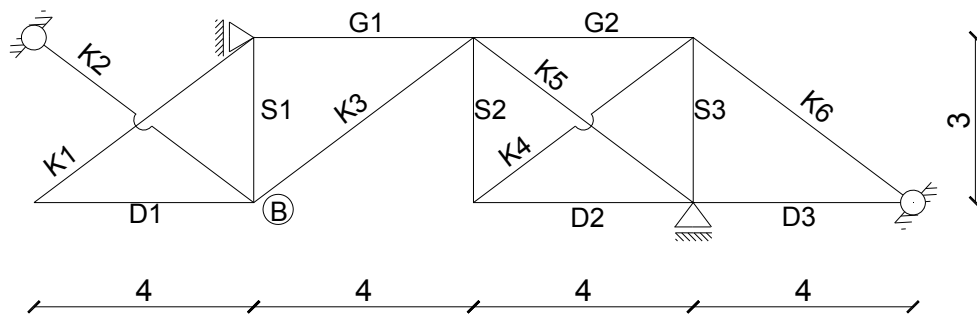

## Obliczenie przemieszczenia pionowego punktu B z twierdzenia redukcyjnego:

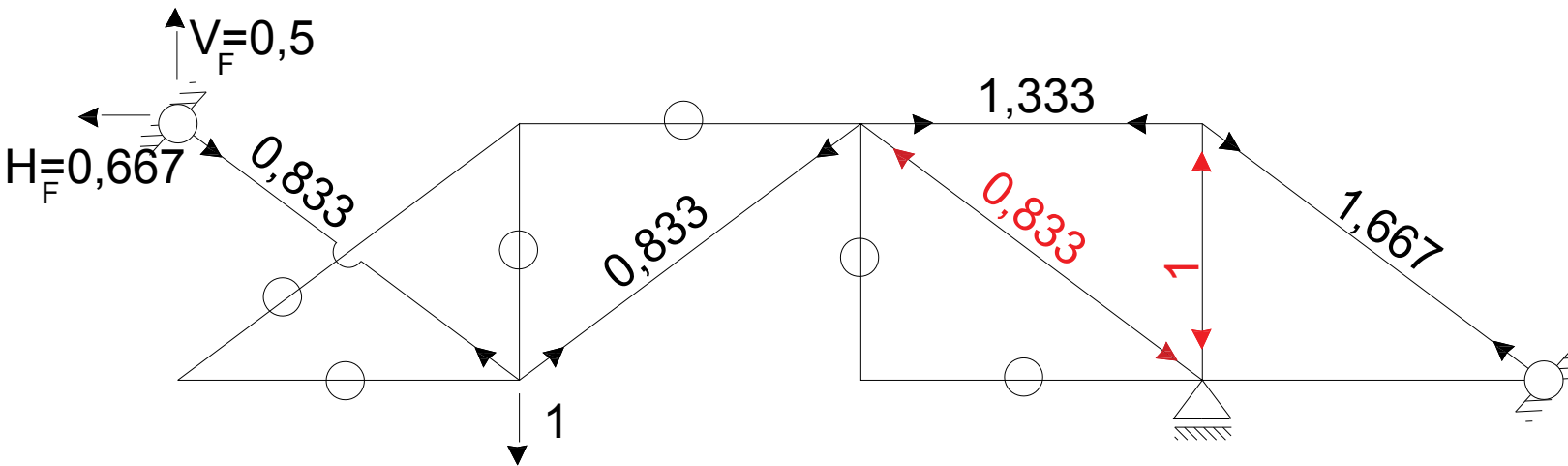

$$\sum M_H^L = -1 \cdot 4 - V_F \cdot 8 = 0 \rightarrow V_F = 0,5$$

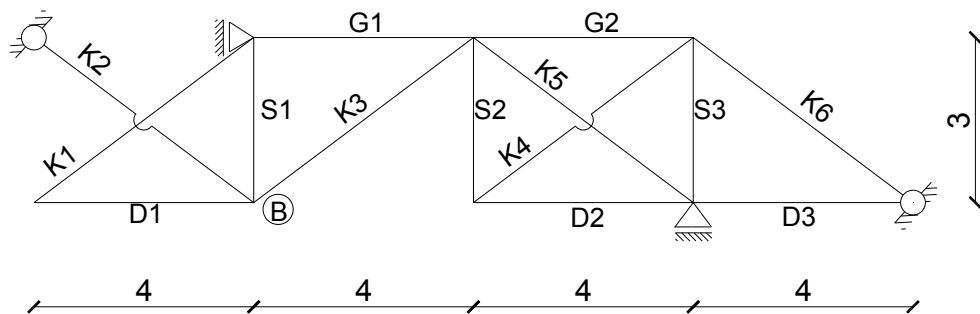

## Obliczenie przemieszczenia pionowego punktu B z twierdzenia redukcyjnego:

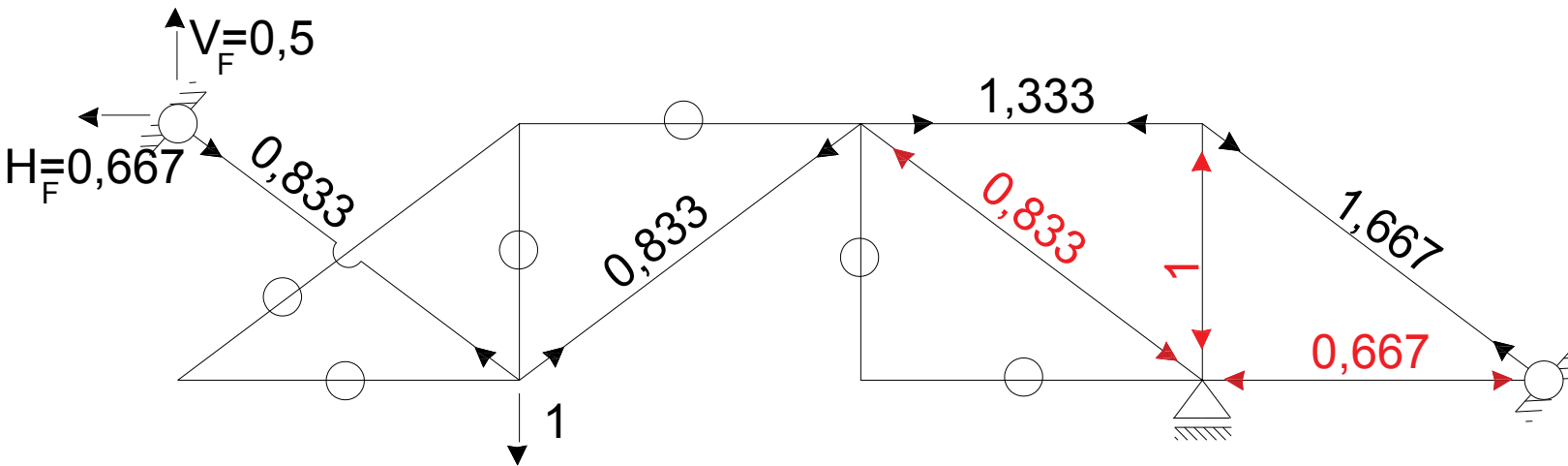

$$\sum M_H^L = -1 \cdot 4 - V_F \cdot 8 = 0 \rightarrow V_F = 0,5$$

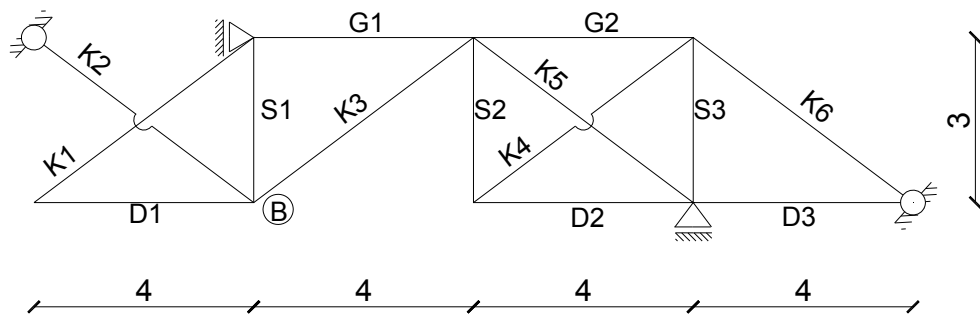

## Obliczenie przemieszczenia pionowego punktu B z twierdzenia redukcyjnego:

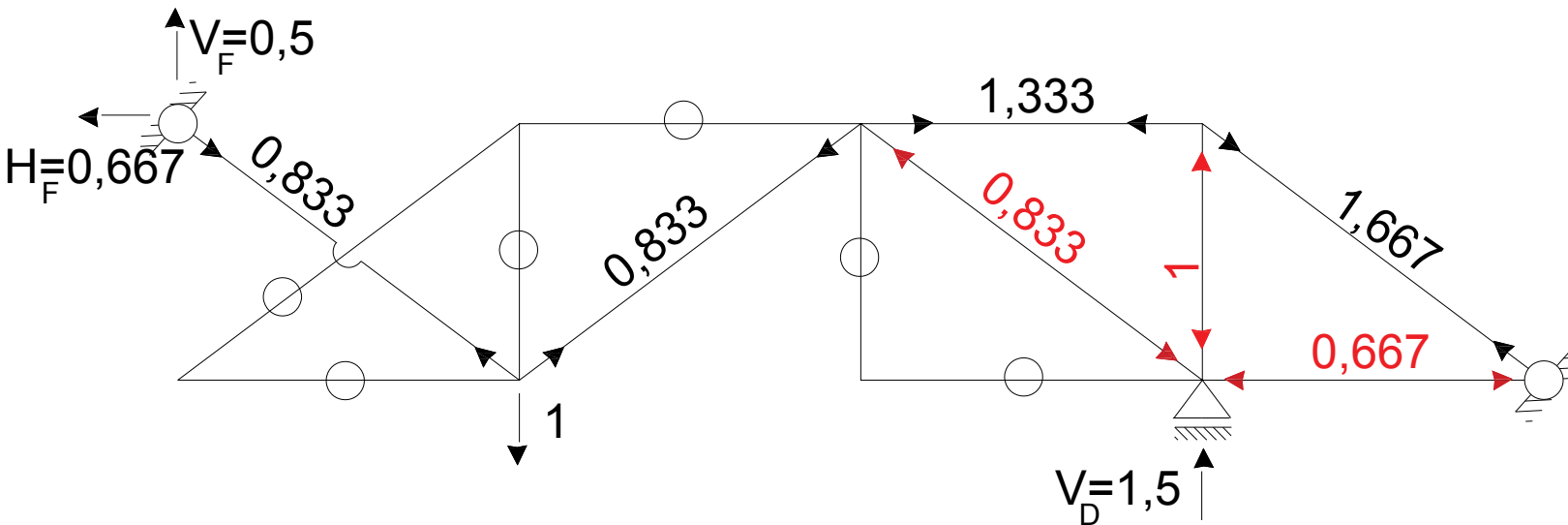

$$\sum M_H^L = -1 \cdot 4 - V_F \cdot 8 = 0 \rightarrow V_F = 0,5$$

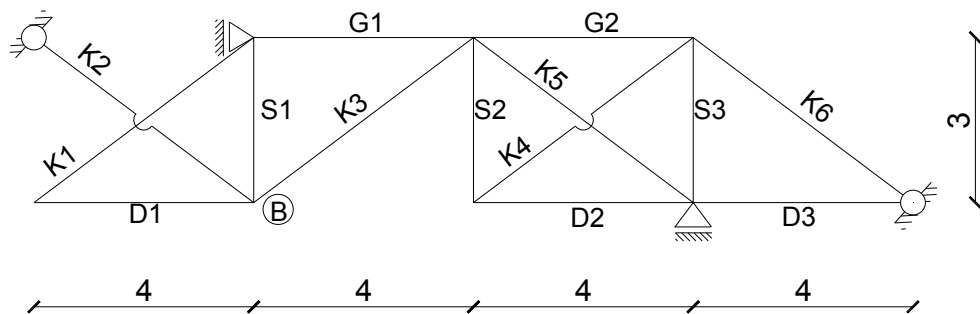

## Obliczenie przemieszczenia pionowego punktu B z twierdzenia redukcyjnego:

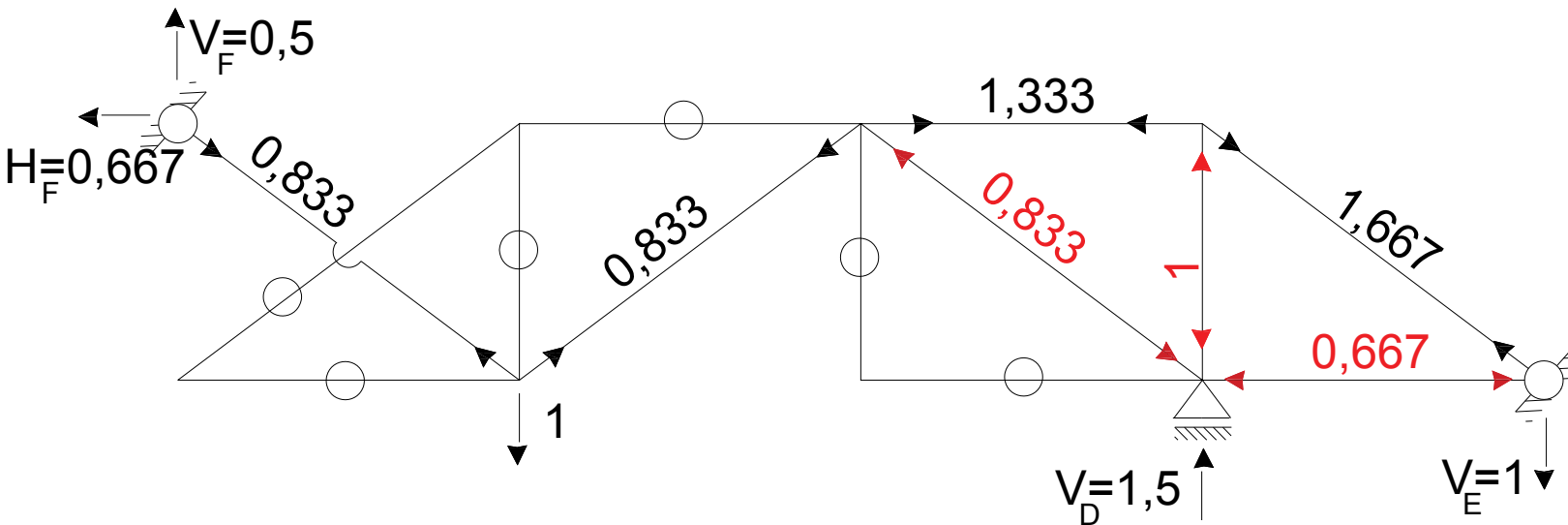

$$\sum M_H^L = -1 \cdot 4 - V_F \cdot 8 = 0 \rightarrow V_F = 0,5$$

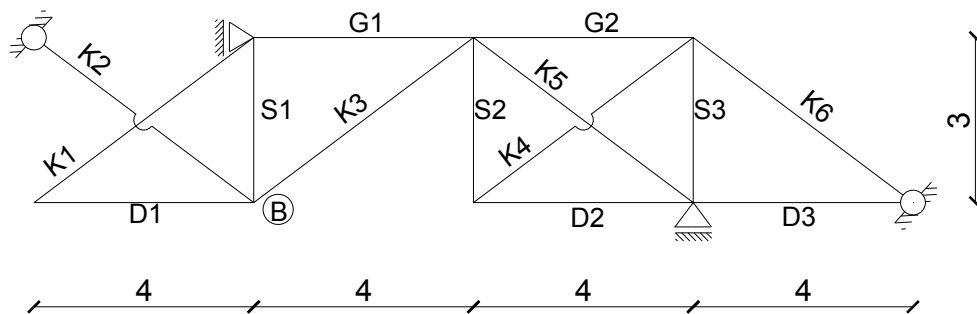

## Obliczenie przemieszczenia pionowego punktu B z twierdzenia redukcyjnego:

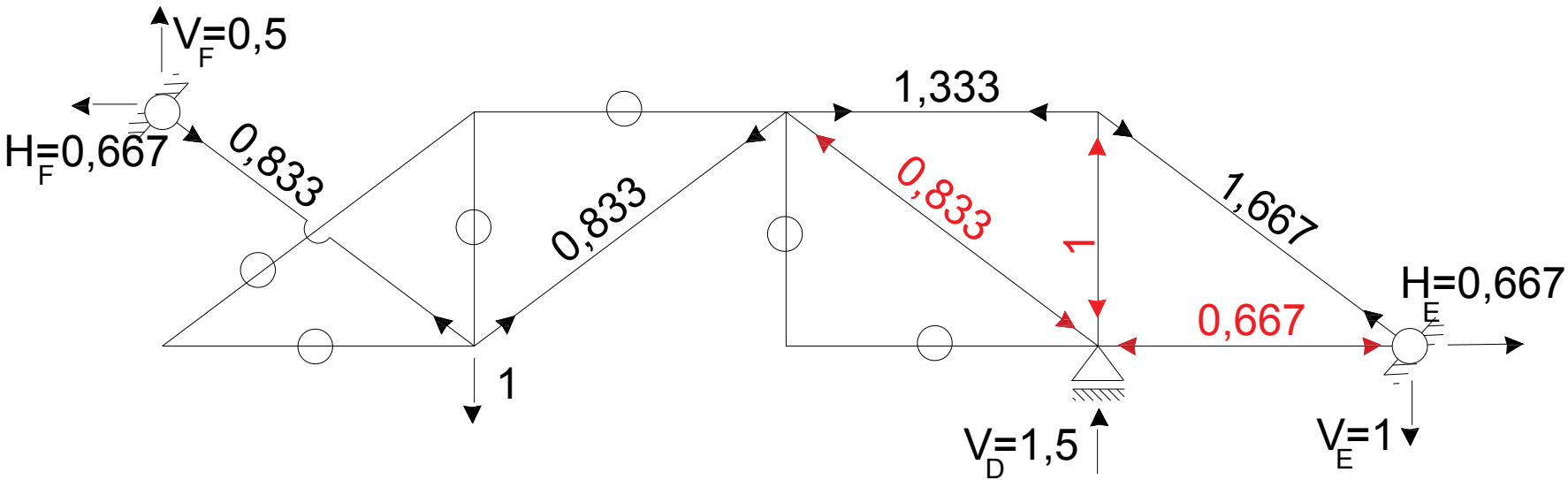

$$\sum M_H^L = -1 \cdot 4 - V_F \cdot 8 = 0 \rightarrow V_F = 0,5$$

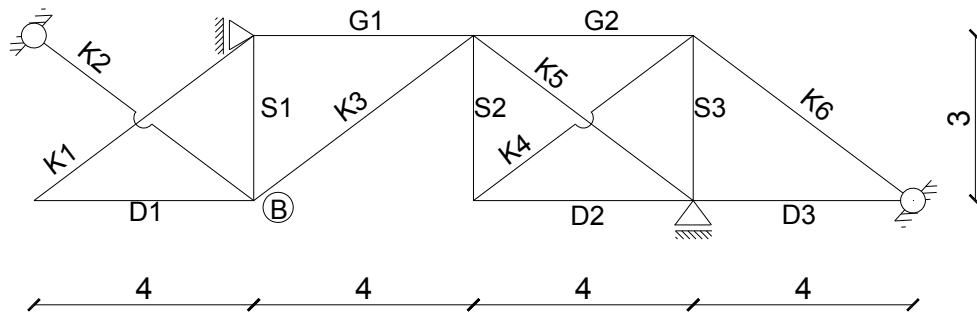

## Obliczenie przemieszczenia pionowego punktu B z twierdzenia redukcyjnego:

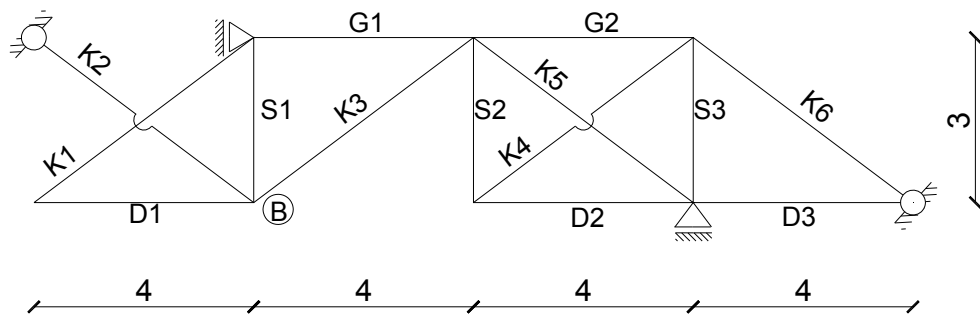
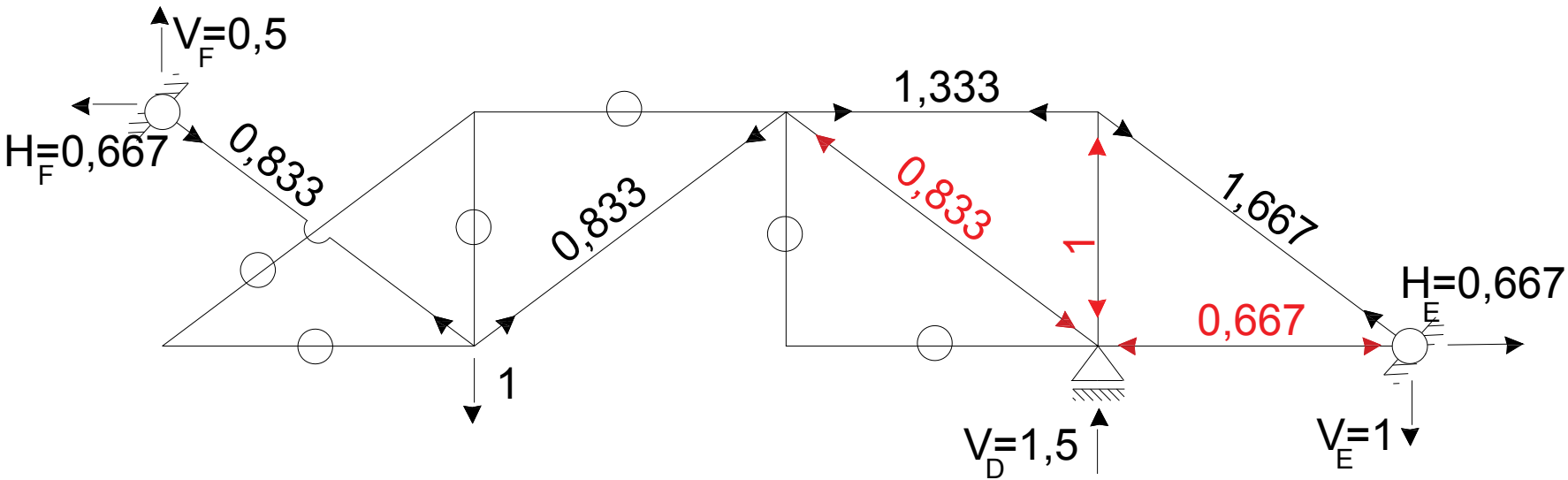

Pręt	L/EA	$\bar{N}$
D1	4	0,000
D2	4	0,000
D3	4	-0,667
G1	4	0,000
G2	4	1,333
S1	3	0,000
S2	3	0,000
S3	3	-1,000
K1	2,5	0,000
K2	2,5	0,833
K3	2,5	0,833
K4	2,5	0,000
K5	2,5	-0,833
K6	2,5	1,667

## Obliczenie przemieszczenia pionowego punktu B z twierdzenia redukcyjnego:

Pręt	L/EA	$\bar{N}$	N	$\bar{N} \cdot N \cdot L/EA$
D1	4	0,000	-24,000	0,000
D2	4	0,000	-5,857	0,000
D3	4	-0,667	-24,000	64,000
G1	4	0,000	-15,942	0,000
G2	4	1,333	2,201	11,740
S1	3	0,000	-18,000	0,000
S2	3	0,000	-4,393	0,000
S3	3	-1,000	-10,437	31,310
K1	2,5	0,000	30,000	0,000
K2	2,5	0,833	30,000	62,500
K3	2,5	0,833	0,000	0,000
K4	2,5	0,000	7,322	0,000
K5	2,5	-0,833	-22,678	47,247
K6	2,5	1,667	10,073	41,971
				258,768

Przemieszczenie pionowe punktu B wynosi  $v_B = 258,768/EA$